

Typical Applications

The HMC199MS8 / 199MS8E is ideal for:

- Cellular
- ISM Basestations
- PCS

Features

- RoHS-Compliant Product
- Integrated Dual SPDTs
- Low Insertion Loss: <0.5 dB @ 2.0 GHz
- Positive Control: 0/+5V
- Ultra Small MSOP8 Package: 14.8 mm²

Functional Diagram

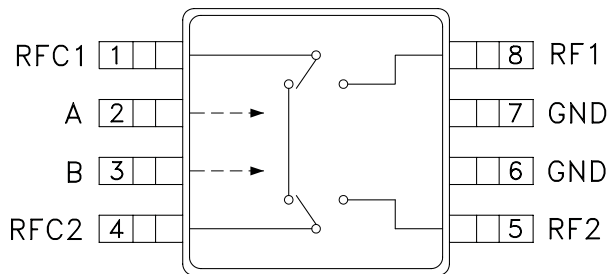

General Description

The HMC199MS8 & HMC199MS8E are low-cost general purpose dual SPDT GaAs “bypass” switches in 8-lead MSOP packages covering DC to 2.5 GHz. These four-RF- port components integrate two SPDT switches and a through line onto a single IC. The designs provide low insertion loss of less than 0.5 dB while switching passive or active external circuit components in and out of the signal path. Port to port isolations are typically 25 to 30 dB. On-chip circuitry enables positive voltage control operation at very low DC currents with control inputs compatible with CMOS and most TTL logic families. Applications include LNA or filter bypass switching and single bit attenuator switching. The HMC199MS8E is a RoHS-compliant product.

Electrical Specifications, $T_A = +25^\circ\text{C}$, $V_{ctl} = 0/+5\text{Vdc}$, 50 Ohm System

| Parameter | Frequency | Min. | Typ. | Max. | Units |
|---|---------------|------|------|------|-------|
| Insertion Loss | DC - 1.0 GHz | | 0.3 | 0.6 | dB |
| | DC - 2.0 GHz | | 0.5 | 0.8 | dB |
| | DC - 2.5 GHz | | 0.7 | 1.0 | dB |
| Isolation | DC - 2.0 GHz | 22 | 25 | | dB |
| | DC - 2.5 GHz | 17 | 21 | | dB |
| Return Loss (On State, Any Port) | DC - 2.0 GHz | 17 | 20 | | dB |
| | DC - 2.5 GHz | 12 | 15 | | dB |
| Input Power for 1 dB Compression | 0.5 - 2.0 GHz | 19 | 23 | | dBm |
| Input Third Order Intercept (Two-tone Input Power = 0 dBm Each Tone) | 0.5 - 2.0 GHz | 32 | 36 | | dBm |
| Switching Characteristics | DC - 2.5 GHz | | | | |
| tRISE, tFALL (10/90% RF) | | | 20 | | ns |
| tON, tOFF (50% CTL to 10/90% RF) | | | 40 | | ns |



Insertion Loss

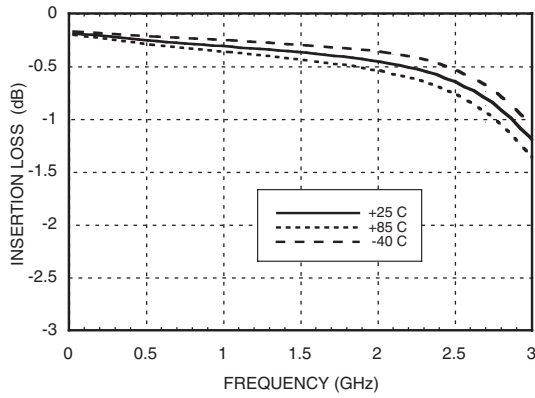

Isolation

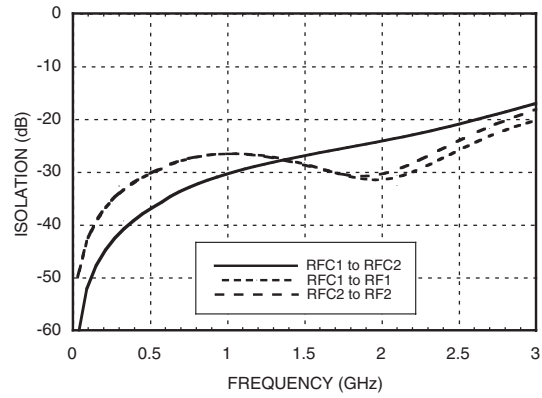

Return Loss

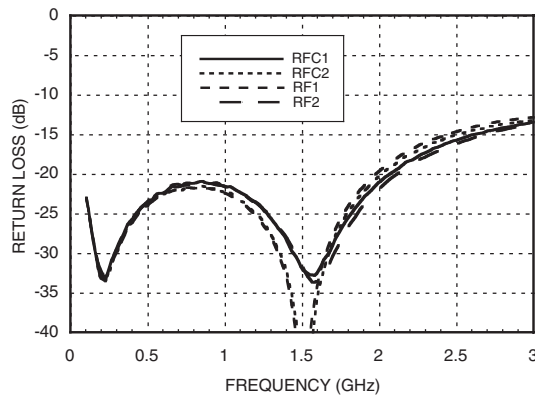

Note:

Isolation between RF1 - RF2 (when RFC1 - RFC2 is in insertion loss state) is 25 dB @ 1 GHz and 17 dB @ 2 GHz.



Compression vs. Frequency

| CTL Input | Carrier at 900MHz | | Carrier at 1900MHz | |
|-----------|------------------------------------|------------------------------------|------------------------------------|------------------------------------|
| | Input Power for 0.1 dB Compression | Input Power for 1.0 dB Compression | Input Power for 0.1 dB Compression | Input Power for 1.0 dB Compression |
| (Vdc) | (dBm) | (dBm) | (dBm) | (dBm) |
| +5 | 20 | 23.5 | 19 | 22 |

Distortion vs. Frequency

| Control Input (Vdc) | Input Third Order Intercept (dBm) 0 dBm Each Tone | |
|------------------------|--|----------|
| | 900 MHz | 1900 MHz |
| +5 | 34.5 | 37.5 |

Caution: Do not operate continuously at RF power input greater than 1 dB compression and do not "hot switch" power levels greater than +13 dBm (Control = 0/+5Vdc).

Truth Table

*Control Input Tolerances are +/- 0.5 Vdc

| Control Input* | | Control Current (Typical) | | Signal Path | | |
|----------------|---------|---------------------------|---------|--------------|-------------|-------------|
| A (Vdc) | B (Vdc) | Ia (uA) | Ib (uA) | RFC1 to RFC2 | RFC1 to RF1 | RFC2 to RF2 |
| 0 | +5 | -65 | 65 | ON | OFF | OFF |
| +5 | 0 | 65 | -65 | OFF | ON | ON |

DC blocking capacitors are required at ports RFC1, RFC2, RF1, RF2. Choose value for lowest frequency of operation.

Absolute Maximum Ratings

| | |
|----------------------------------|------------------|
| RF Input Power $V_{CTL} = 0/+5V$ | +24 dBm |
| Control Voltage Range (A & B) | -0.5 to +7.5 Vdc |
| Channel Temperature | 150 °C |
| Thermal Resistance | 172 °C/W |
| Storage Temperature | -65 to +150 °C |
| Operating Temperature | -40 to +85 °C |
| ESD Sensitivity (HBM) | Class 1A |



**ELECTROSTATIC SENSITIVE DEVICE
OBSERVE HANDLING PRECAUTIONS**

Outline Drawing

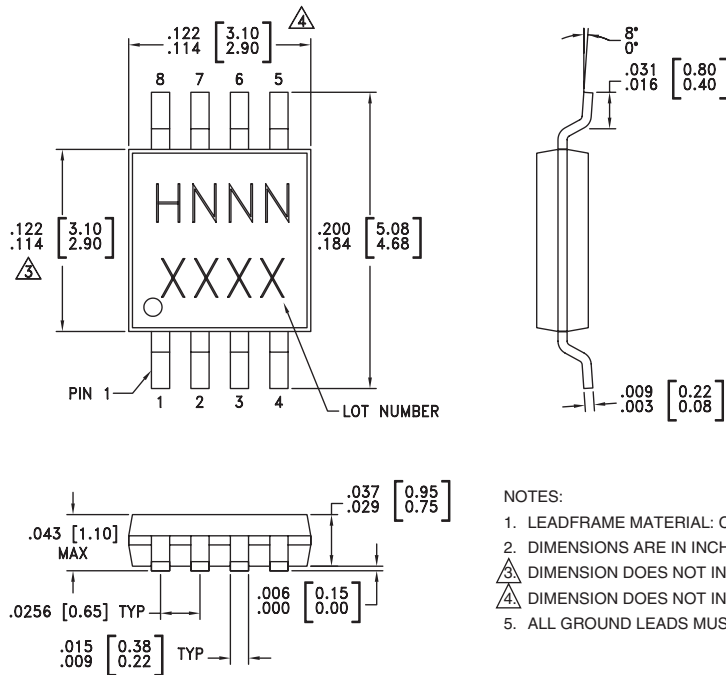

Package Information

| Part Number | Package Body Material | Lead Finish | MSL Rating | Package Marking ^[3] |
|-------------|--|---------------|---------------------|--------------------------------|
| HMC199MS8 | Low Stress Injection Molded Plastic | Sn/Pb Solder | MSL1 ^[1] | H199 XXXX |
| HMC199MS8E | RoHS-compliant Low Stress Injection Molded Plastic | 100% matte Sn | MSL1 ^[2] | H199 XXXX |

[1] Max peak reflow temperature of 235 °C

[2] Max peak reflow temperature of 260 °C

[3] 4-Digit lot number XXXX

Typical Application Circuit

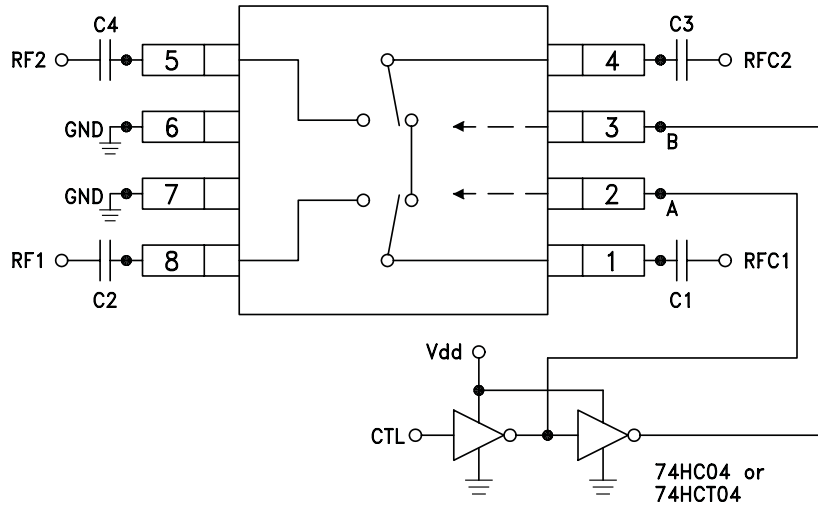

Notes:

1. Set A/B control to 0/+5V, Vdd = +5V and use HCT series logic to provide a TTL driver interface.
2. Control inputs A/B can be driven directly with CMOS logic (HC) with Vdd = 5 to 7 Volts applied to the CMOS logic gates.
3. DC Blocking capacitors are required for each RF port as shown. Capacitor value determines lowest frequency of operation.
4. Highest RF signal power capability is achieved with Vdd = +7V and A/B set to 0/+7V.
5. For further information refer to "Using the HMC199MS8 as a Low-Cost 1-Bit Attenuator" product note.

Eval Board Layout (Top View)

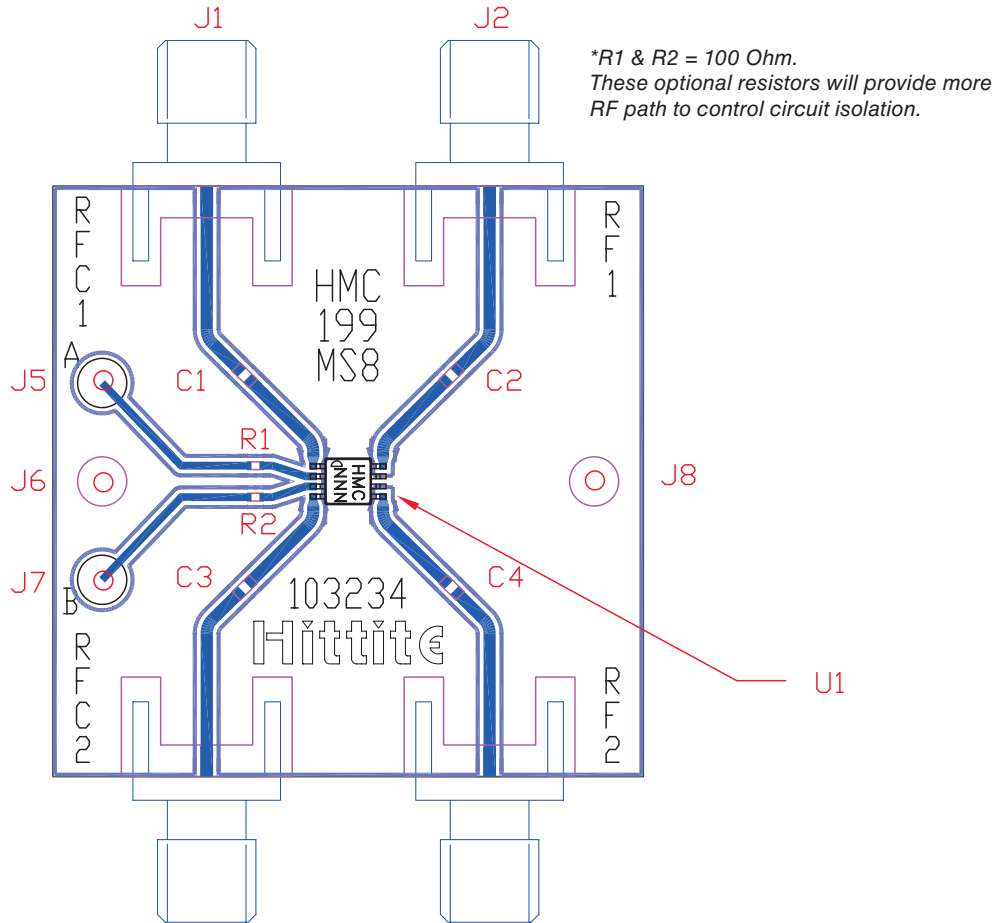

List of Materials for Evaluation PCB 103236 [1]

| Item | Description |
|---------|--|
| J1 - J4 | PCB Mount SMA RF Connector |
| J5 - J8 | DC Pin |
| C1 - C4 | Chip Capacitor, 0402 Pkg. Choose value for lowest frequency of operation. 330 pF is provided on PCB. |
| R1 - R2 | 100 Ohm Resistor, 0402 Pkg. |
| U1 | HMC199MS8 / HMC199MS8E Bypass Switch |
| PCB [2] | 103234 Evaluation PCB 1.5" x 1.5" |

[1] Reference this number when ordering complete evaluation PCB

[2] Circuit Board Material: Rogers 4350

The circuit board used in the final application should be generated with proper RF circuit design techniques. Signal lines at the RF ports should have 50 ohm impedance. The evaluation circuit board shown above is available from Hittite Microwave Corporation upon request.