

GaAs MMIC DOUBLE-BALANCED MIXER, 5 - 20 GHz

Typical Applications

The HMC143 & HMC144 is ideal for:

- Microwave Point-to-Point Radios
- VSAT

Features

- Input IP3: +25 dBm
- LO / RF Isolation: 30 dB
- IF Bandwidth: DC to 3 GHz
- Small Size: 2.10 x 1.45 x 0.1 mm

Functional Diagram

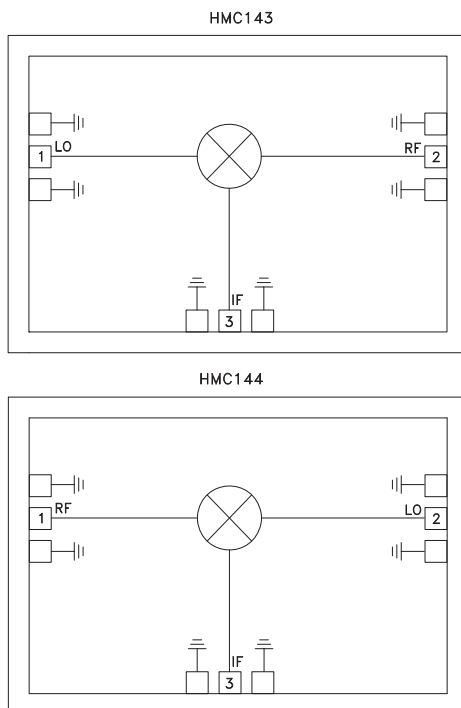

General Description

The HMC143 chip is a miniature double-balanced mixer which can be used as an upconverter or down-converter. The chip utilizes a standard 1 μ m GaAs MESFET process. The HMC144 is identical to the HMC143 except that the layout is a mirror image designed to ease integration into image-reject mixer modules. Broadband operation and excellent isolations are provided by on-chip baluns, which require no external components and no DC bias. The design is similar to the HMC141/142 mixers but with an IF combiner in a double-balanced design, providing improved RF/IF isolation. These devices are much smaller and more reliable replacements to hybrid diode mixers.

Electrical Specifications, $T_A = +25^\circ C$, LO Drive = +20 dBm

Parameter	Min.	Typ.	Max.	Min.	Typ.	Max.	Min.	Typ.	Max.	Units
Frequency Range, RF & LO	5 - 10.5			10.5 - 15.5			15.5 - 20			GHz
Frequency Range, IF	DC - 3			DC - 3			DC - 3			GHz
Conversion Loss		10	12		10	12		10	12	dB
Noise Figure (SSB)		10	12		10	12		10	12	dB
LO to RF Isolation	26	30		24	28		26	30		dB
LO to IF Isolation	15	18		12	15		14	17		dB
IP3 (Input)		21			25			23		dBm
IP2 (Input)		50			50			50		dBm
1 dB Gain Compression (Input)	10	15		10	15		10	15		dBm

**GaAs MMIC DOUBLE-BALANCED
MIXER, 5 - 20 GHz**

**Conversion Gain vs.
Temperature @ LO = +20 dBm**

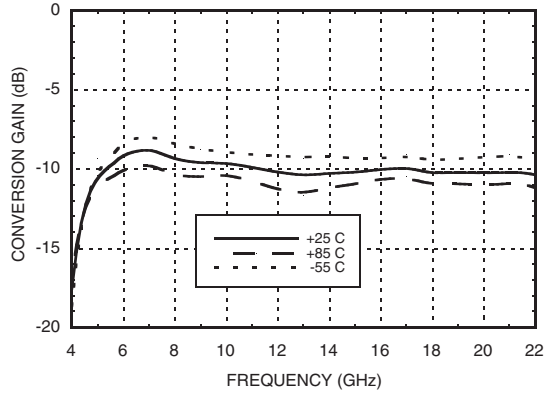

Isolation @ LO = +20 dBm

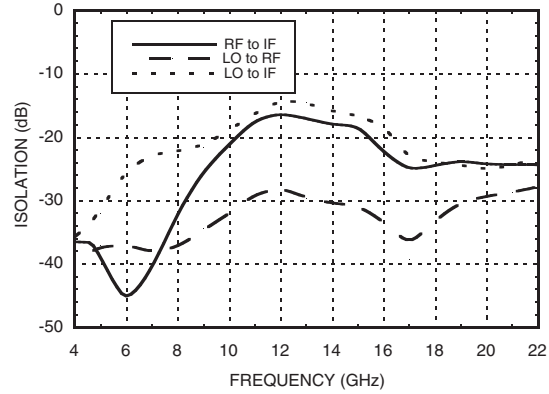

Conversion Gain vs. LO Drive

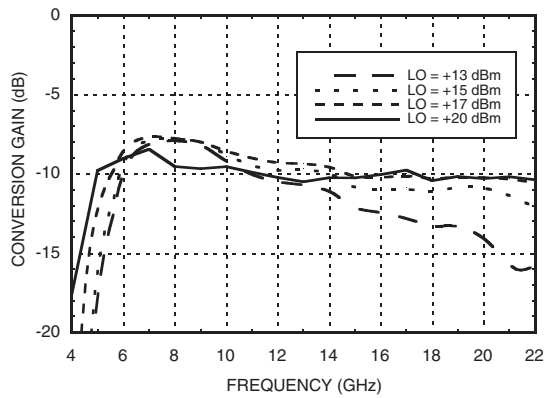

Return Loss @ LO = +20 dBm

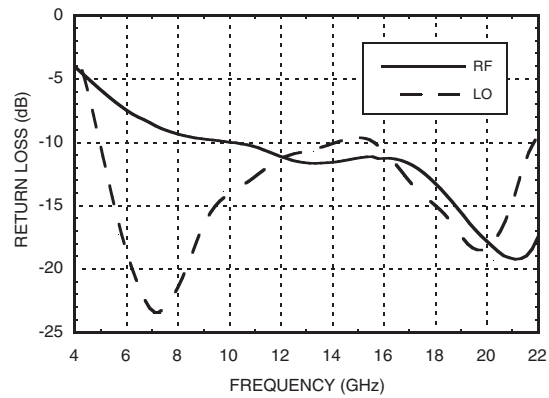

IF Bandwidth @ LO = +20 dBm

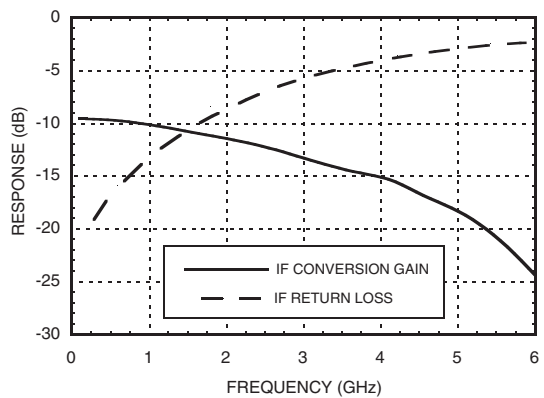

**Upconverter Performance
Conversion Gain @ LO = +20 dBm**

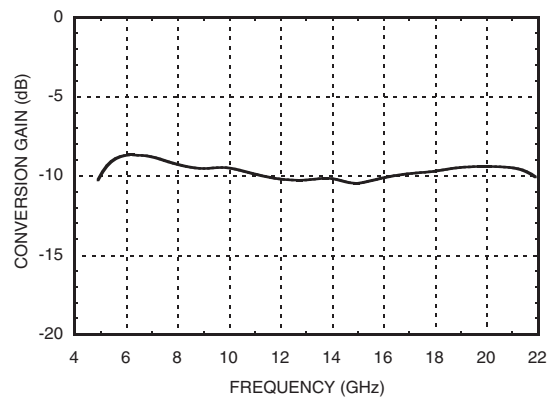

GaAs MMIC DOUBLE-BALANCED MIXER, 5 - 20 GHz

Input IP3 vs. LO Drive*

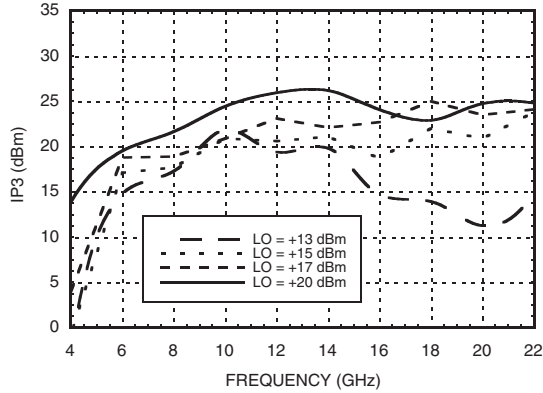

Input IP3 vs. Temperature @ LO = +20 dBm

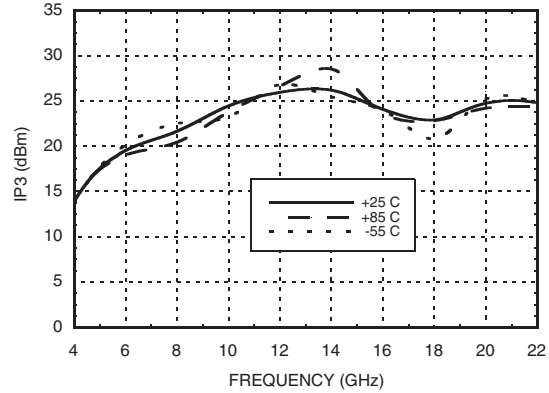

Input IP2 vs. LO Drive*

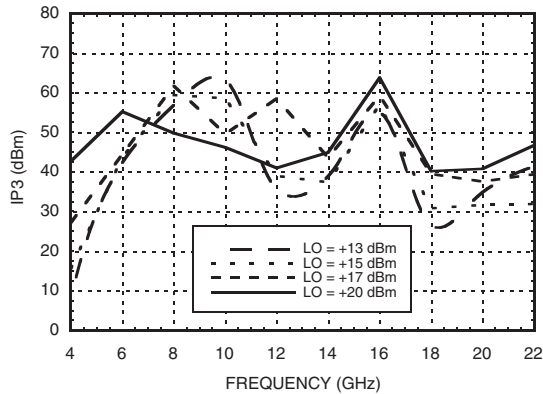

Input P1dB vs. Temperature @ LO = +20 dBm

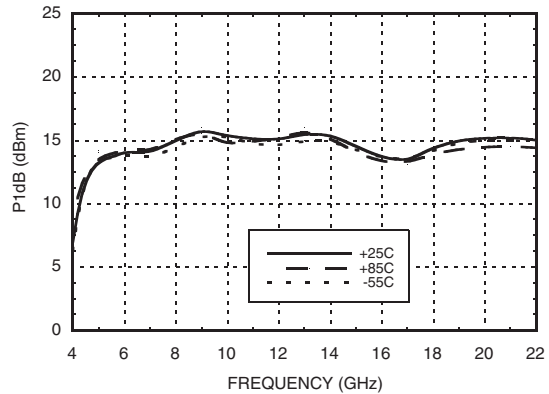

* Two-tone input power = 0 dBm each tone, 1 MHz spacing.

GaAs MMIC DOUBLE-BALANCED MIXER, 5 - 20 GHz

MxN Spurious @ IF Port

mRF	nLO				
	0	1	2	3	4
0	XX	-11	18	2	22
1	43	0	46	15	31
2	67	61	63	69	68
3	77	74	80	68	80
4	72	77	77	80	80

RF = 6 GHz @ -10 dBm
LO = 6.1 GHz @ 20 dBm
All values in dBc relative to the IF power level.
Measured as downconverter.

Harmonics of LO

LO Freq. (GHz)	nLO Spur @ RF Port			
	1	2	3	4
6	37	35	58	38
8	38	36	54	46
10	33	36	50	56
12	28	28	41	N/A
14	30	40	N/A	N/A
16	33	41	N/A	N/A
18	32	47	N/A	N/A
20	29	43	N/A	N/A

LO = +20 dBm
All values in dBc below input LO level @ RF port.

Absolute Maximum Ratings

RF / IF Input	+15 dBm
LO Drive	+27 dBm
IF DC Current	± 2 mA
Channel Temperature	150 °C
Continuous P _{diss} (T=85 °C) (derate 14.2 mW/°C above 85 °C)	924 mW
Thermal Resistance (R _{TH}) (junction to package bottom)	70.4 °C/W
Storage Temperature	-65 to +150 °C
Operating Temperature	-55 to +85 °C
ESD Sensitivity (HBM)	Class 1A

Die Packaging Information ^[1]

Standard	Alternate
WP-4	[2]

[1] Refer to the "Packaging Information" section for die packaging dimensions.

[2] For alternate packaging information contact Hittite Microwave Corporation.



**ELECTROSTATIC SENSITIVE DEVICE
OBSERVE HANDLING PRECAUTIONS**

Outline Drawings (See HMC143/144 Operation Application Note)

HMC143

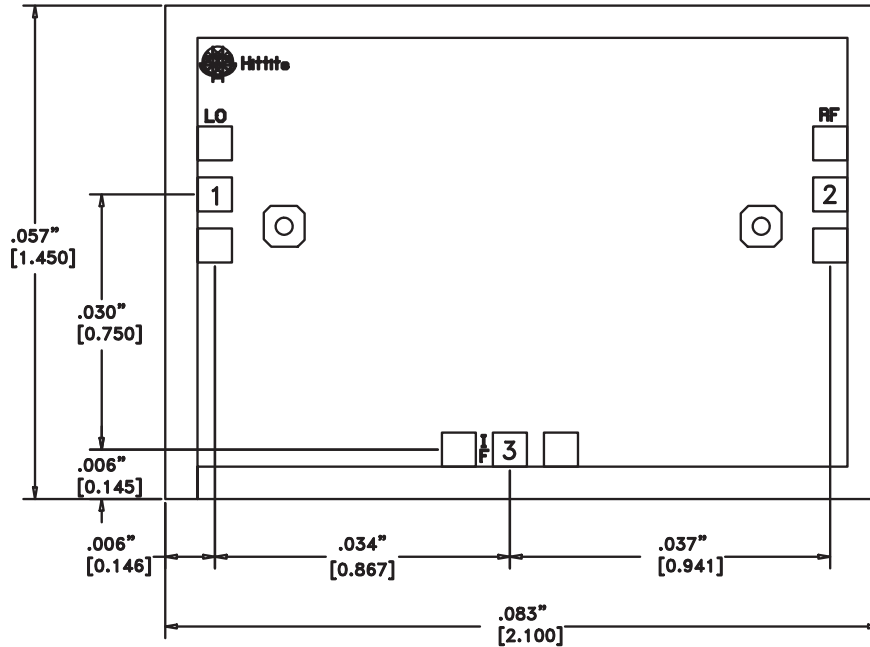



NOTES:

1. ALL DIMENSIONS ARE IN INCHES [MM].
2. DIE THICKNESS IS .004".
3. TYPICAL BOND PAD IS .004" SQUARE.
4. BACKSIDE METALLIZATION: GOLD.
5. BOND PAD METALLIZATION: GOLD.
6. BACKSIDE METAL IS GROUND.
7. CONNECTION NOT REQUIRED FOR UNLABELED BOND PADS.

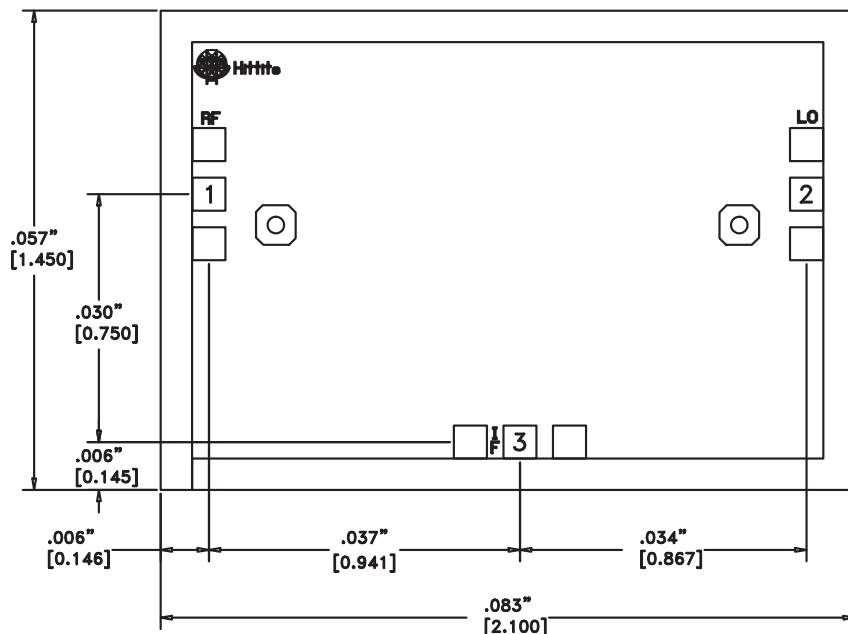
HMC144

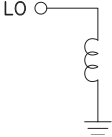
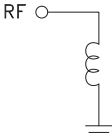
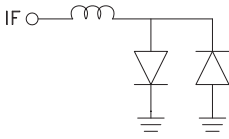

Pad Descriptions HMC143 (HMC144)

Pad Number	Function	Description	Interface Schematic
1 (2)	LO	This pin is AC coupled and matched to 50 Ohms.	
2 (1)	RF	This pin is AC coupled and matched to 50 Ohms.	
3 (3)	IF	This pin is DC coupled. For applications not requiring operation to DC, this port should be DC blocked externally using a series capacitor whose value has been chosen to pass the necessary IF frequency range. For operation to DC, this pin must not source/sink more than 2 mA of current or die non-function and possible die failure will result.	
	GND	The backside of the die must be connected to RF ground.	

Assembly Drawing

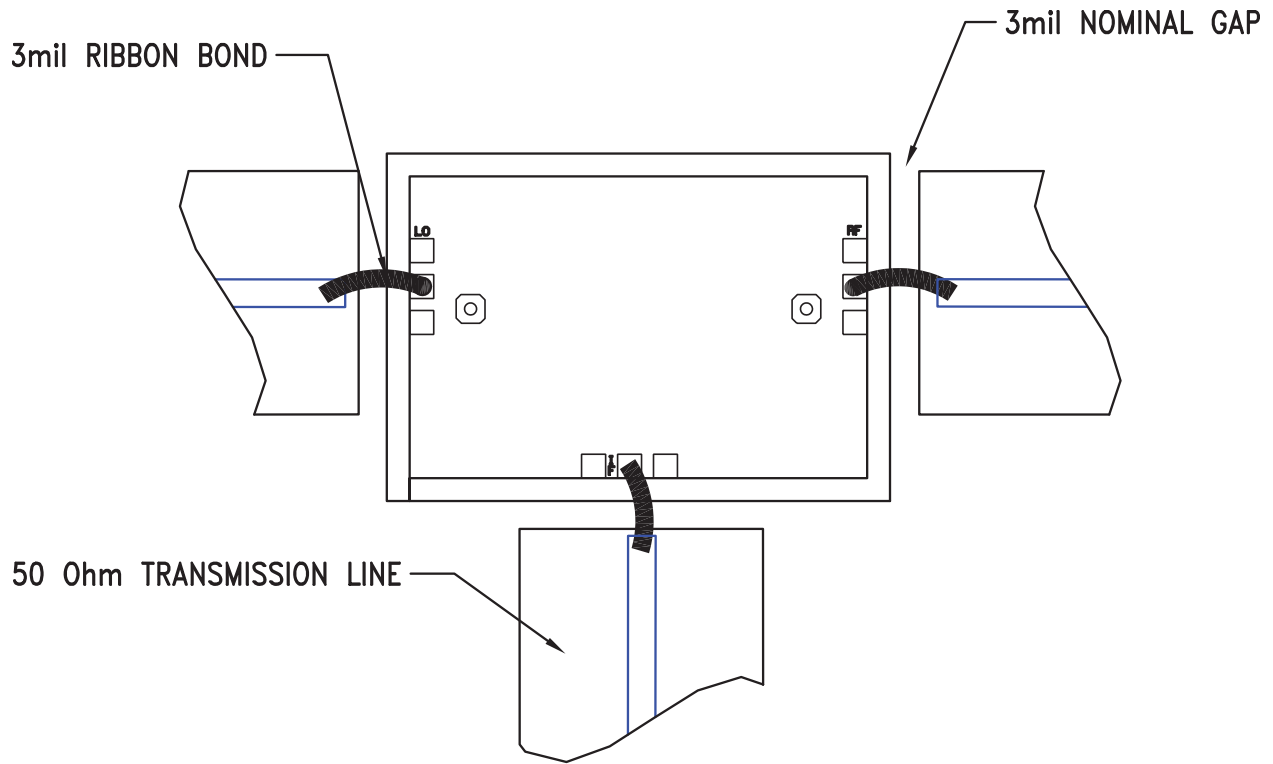

Handling Precautions

Follow these precautions to avoid permanent damage.

Storage: All bare die are placed in either Waffle or Gel based ESD protective containers, and then sealed in an ESD protective bag for shipment. Once the sealed ESD protective bag has been opened, all die should be stored in a dry nitrogen environment.

Cleanliness: Handle the chips in a clean environment. DO NOT attempt to clean the chip using liquid cleaning systems.

Static Sensitivity: Follow ESD precautions to protect against ESD strikes.

Transients: Suppress instrument and bias supply transients while bias is applied. Use shielded signal and bias cables to minimize inductive pick-up.

General Handling: Handle the chip along the edges with a vacuum collet or with a sharp pair of bent tweezers. The surface of the chip has fragile air bridges and should not be touched with vacuum collet, tweezers, or fingers.

Mounting

The chip is back-metallized and can be die mounted with AuSn eutectic preforms or with electrically conductive epoxy. The mounting surface should be clean and flat.

Eutectic Die Attach: A 80/20 gold tin preform is recommended with a work surface temperature of 255 °C and a tool temperature of 265 °C. When hot 90/10 nitrogen/hydrogen gas is applied, tool tip temperature should be 290 °C. DO NOT expose the chip to a temperature greater than 320 °C for more than 20 seconds. No more than 3 seconds of scrubbing should be required for attachment.

Epoxy Die Attach: Apply a minimum amount of epoxy to the mounting surface so that a thin epoxy fillet is observed around the perimeter of the chip once it is placed into position. Cure epoxy per the manufacturer's schedule.

Wire Bonding

RF bonds made with 0.003" x 0.0005" ribbon are recommended. These bonds should be thermosonically bonded with a force of 40-60 grams. DC bonds of 0.001" (0.025 mm) diameter, thermosonically bonded, are recommended. Ball bonds should be made with a force of 40-50 grams and wedge bonds at 18-22 grams. All bonds should be made with a nominal stage temperature of 150 °C. A minimum amount of ultrasonic energy should be applied to achieve reliable bonds. All bonds should be as short as possible, less than 12 mils (0.31 mm).