

HFA80NC40C

HEXFRED™

Ultrafast, Soft Recovery Diode

Features

- Reduced RFI and EMI
- Reduced Snubbing
- Extensive Characterization of Recovery Parameters

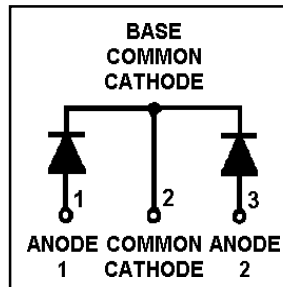

| |
|---|
| $V_R = 400V$ |
| $V_F(\text{typ.})^{\textcircled{3}} = 1V$ |
| $I_{F(AV)} = 80A$ |
| $Q_{rr}(\text{typ.}) = 200nC$ |
| $I_{RRM}(\text{typ.}) = 6A$ |
| $t_{rr}(\text{typ.}) = 30ns$ |
| $di_{(rec)}/dt(\text{typ.})^{\textcircled{3}} = 190A/\mu s$ |

Description

HEXFRED™ diodes are optimized to reduce losses and EMI/RFI in high frequency power conditioning systems. An extensive characterization of the recovery behavior for different values of current, temperature and di/dt simplifies the calculations of losses in the operating conditions. The softness of the recovery eliminates the need for a snubber in most applications. These devices are ideally suited for power converters, motors drives and other applications where switching losses are significant portion of the total losses.

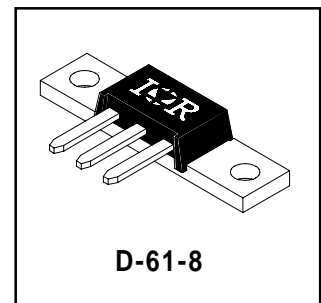

Absolute Maximum Ratings (per Leg)

| | Parameter | Max. | Units |
|---------------------------|-----------------------------------|-------------|-------|
| V_R | Cathode-to-Anode Voltage | 400 | V |
| $I_F @ T_C = 25^\circ C$ | Continuous Forward Current | 85 | A |
| $I_F @ T_C = 100^\circ C$ | Continuous Forward Current | 42 | |
| I_{FSM} | Single Pulse Forward Current ① | 300 | |
| E_{AS} | Non-Repetitive Avalanche Energy ② | 1.4 | mJ |
| $P_D @ T_C = 25^\circ C$ | Maximum Power Dissipation | 150 | W |
| $P_D @ T_C = 100^\circ C$ | Maximum Power Dissipation | 59 | |
| T_J | Operating Junction and | -55 to +150 | °C |
| T_{STG} | Storage Temperature Range | | |

Thermal - Mechanical Characteristics

| | Parameter | Min. | Typ. | Max. | Units |
|------------|---|----------|------------|----------|-----------------|
| R_{thJC} | Junction-to-Case, Single Leg Conducting | — | — | 0.85 | °C/W K/W |
| | Junction-to-Case, Both Legs Conducting | — | — | 0.42 | |
| R_{thCS} | Case-to-Sink, Flat , Greased Surface | — | 0.30 | — | |
| Wt | Weight | — | 7.8 (0.28) | — | g (oz) |
| | Mounting Torque | 35 (4.0) | — | 50 (5.7) | lbf•in (N•m) |

Note: ① Limited by junction temperature
 ② L = 100μH, duty cycle limited by max T_J
 ③ 125°C

Electrical Characteristics (per Leg) @ $T_J = 25^\circ\text{C}$ (unless otherwise specified)

| Parameter | Min. | Typ. | Max. | Units | Test Conditions |
|-----------|------|------|------|---------------|---|
| V_{BR} | 400 | — | — | V | $I_R = 100\mu\text{A}$ |
| V_{FM} | — | 1.1 | 1.3 | V | $I_F = 40\text{A}$ $I_F = 80\text{A}$ $I_F = 40\text{A}, T_J = 125^\circ\text{C}$ |
| | | 1.3 | 1.5 | | |
| | | 1.0 | 1.2 | | |
| I_{RM} | — | 0.50 | 3.0 | μA | $V_R = V_R \text{ Rated}$ |
| | | 0.75 | 4.0 | mA | $T_J = 125^\circ\text{C}, V_R = 320\text{V}$ |
| C_T | — | 90 | 125 | pF | $V_R = 200\text{V}$ |
| L_S | — | 5.5 | — | nH | Lead to lead 5mm from package body |

Dynamic Recovery Characteristics (per Leg) @ $T_J = 25^\circ\text{C}$ (unless otherwise specified)

| Parameter | Min. | Typ. | Max. | Units | Test Conditions |
|-------------------|------|------|------|------------------------|---|
| t_{rr} | — | 30 | — | ns | $I_F = 1.0\text{A}, di/dt = 200\text{A}/\mu\text{s}, V_R = 30\text{V}$ $T_J = 25^\circ\text{C}$ $T_J = 125^\circ\text{C}$ |
| t_{rr1} | — | 67 | 100 | | |
| t_{rr2} | — | 110 | 170 | | |
| I_{RRM1} | — | 6.0 | 11 | A | $T_J = 25^\circ\text{C}$ $T_J = 125^\circ\text{C}$ |
| | | 9.0 | 16 | | |
| I_{RRM2} | — | 200 | 540 | nC | $T_J = 25^\circ\text{C}$ $T_J = 125^\circ\text{C}$ |
| | | 500 | 1300 | | |
| Q_{rr1} | — | 240 | — | $\text{A}/\mu\text{s}$ | $T_J = 25^\circ\text{C}$ $T_J = 125^\circ\text{C}$ |
| Q_{rr2} | — | 190 | — | | |
| $di_{(rec)M}/dt1$ | — | 240 | — | $\text{A}/\mu\text{s}$ | $T_J = 25^\circ\text{C}$ $T_J = 125^\circ\text{C}$ |
| $di_{(rec)M}/dt2$ | — | 190 | — | | |

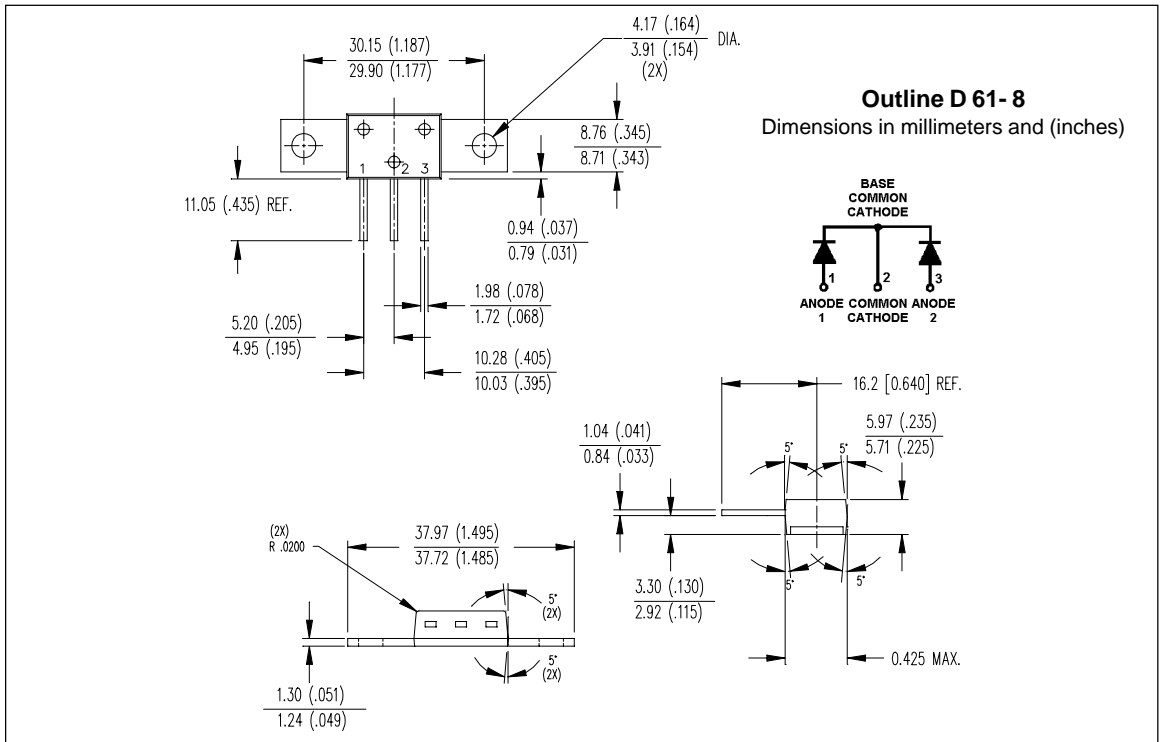

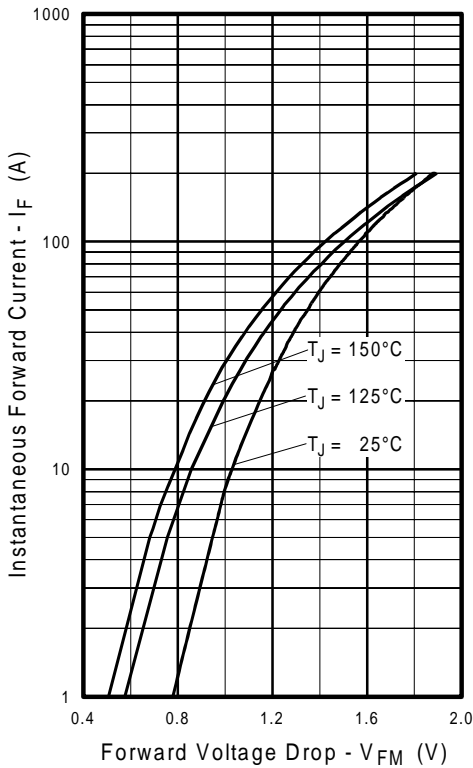

Fig. 1 - Maximum Forward Voltage Drop vs. Instantaneous Forward Current, (per Leg)

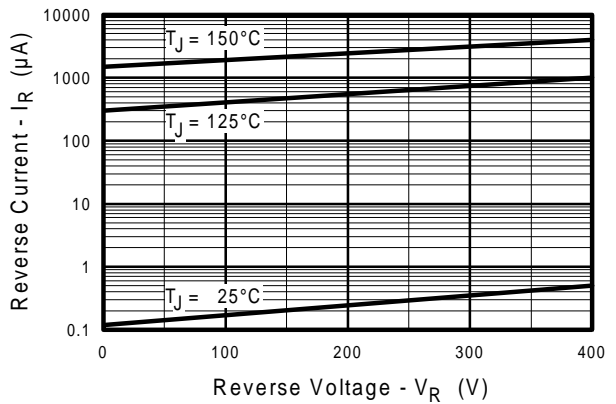

Fig. 2 - Typical Reverse Current vs. Reverse Voltage, (per Leg)

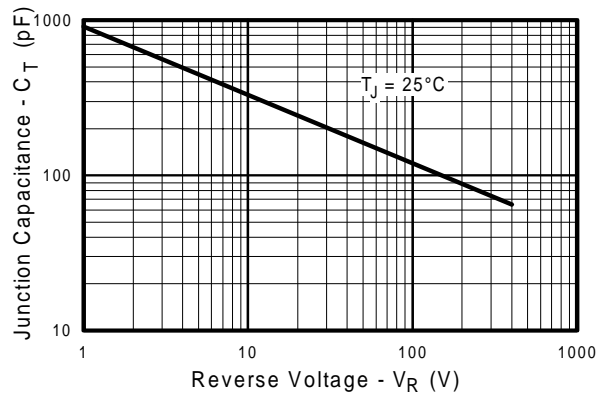

Fig. 3 - Typical Junction Capacitance vs. Reverse Voltage, (per Leg)

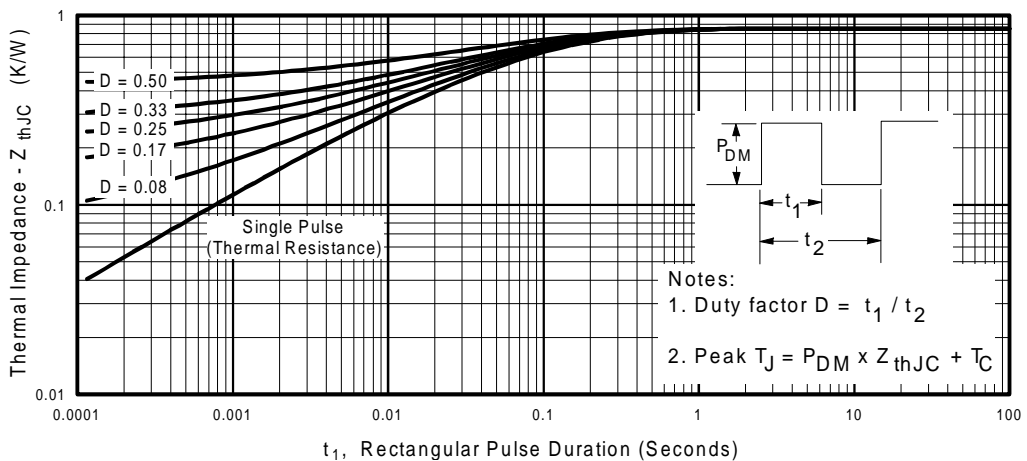

Fig. 4 - Maximum Thermal Impedance Z_{thJC} Characteristics, (per Leg)

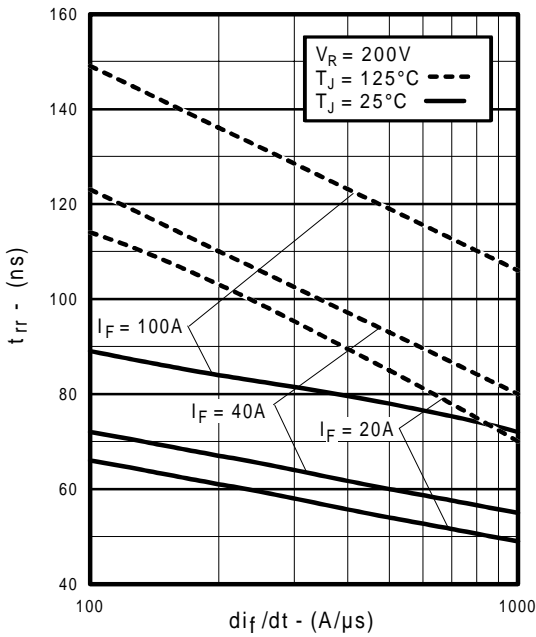

Fig. 5 - Typical Reverse Recovery vs. di_f/dt , (per Leg)

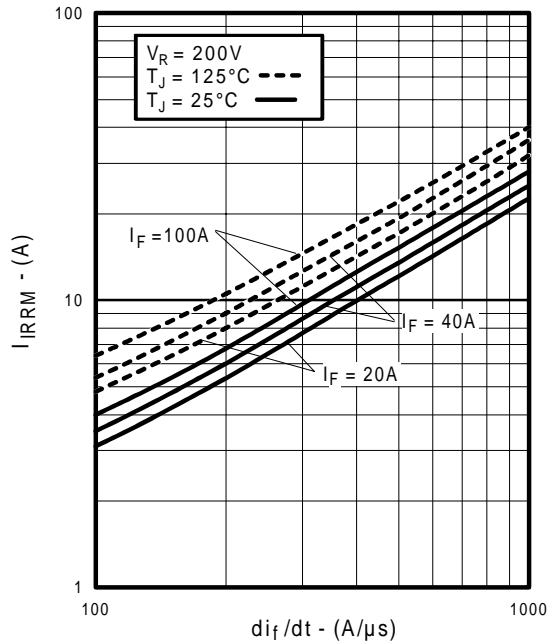

Fig. 6 - Typical Recovery Current vs. di_f/dt , (per Leg)

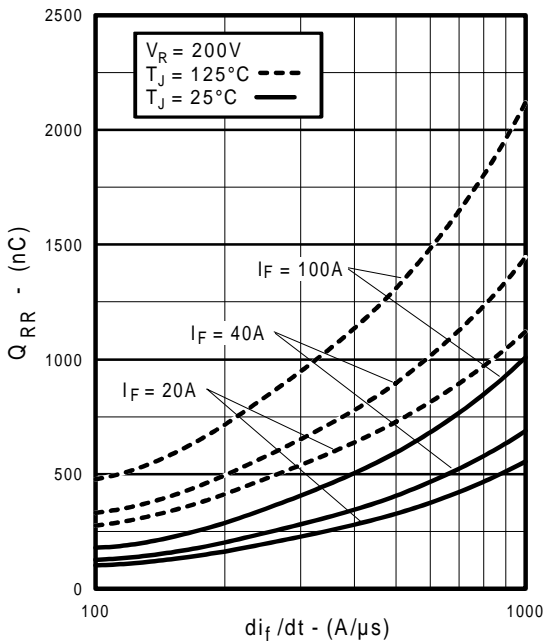

Fig. 7 - Typical Stored Charge vs. di_f/dt , (per Leg)

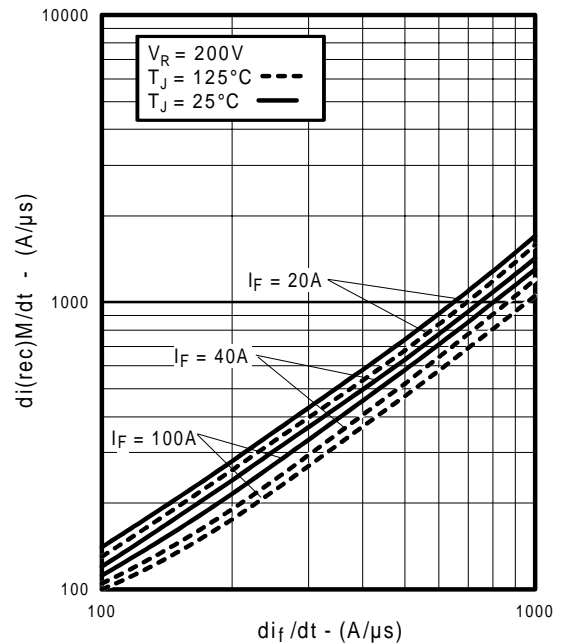

Fig. 8 - Typical $di_{(rec)}M/dt$ vs. di_f/dt , (per Leg)

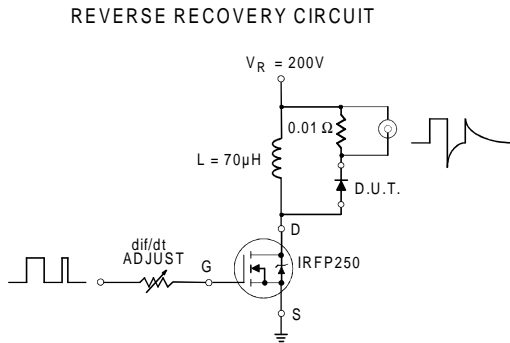
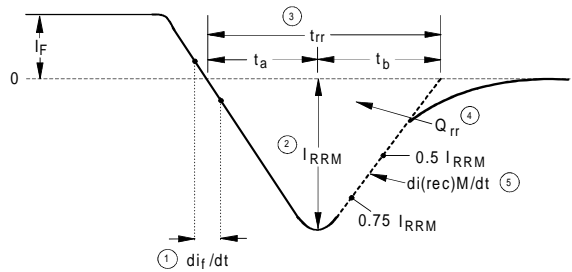

Fig. 9 - Reverse Recovery Parameter Test Circuit



1. di_f/dt - Rate of change of current through zero crossing
2. I_{RRM} - Peak reverse recovery current
3. t_{rr} - Reverse recovery time measured from zero crossing point of negative going I_F to point where a line passing through $0.75 I_{RRM}$ and $0.50 I_{RRM}$ extrapolated to zero current
4. Q_{rr} - Area under curve defined by t_{rr} and I_{RRM}

$$Q_{rr} = \frac{t_{rr} \times I_{RRM}}{2}$$
5. $di_{(rec)M}/dt$ - Peak rate of change of current during t_b portion of t_{rr}

Fig. 10 - Reverse Recovery Waveform and Definitions

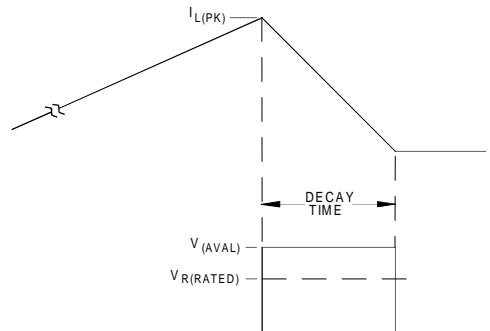
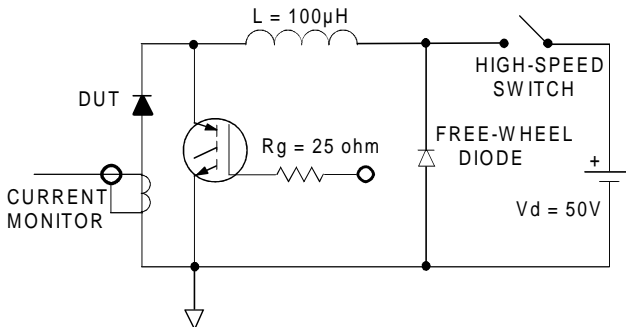

Fig. 11 - Avalanche Test Circuit and Waveforms