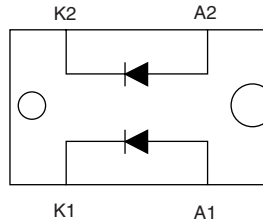

HEXFRED® Ultrafast Soft Recovery Diode, 60 A

SOT-227

FEATURES

- Fast recovery time characteristic
- Electrically isolated base plate
- Large creepage distance between terminal
- Simplified mechanical designs, rapid assembly
- UL pending
- Totally lead (Pb)-free
- Designed for industrial level

**RoHS
COMPLIANT**
DESCRIPTION

This SOT-227 modules with HEXFRED® rectifier are available in two basic configurations. They are the antiparallel and the parallel configurations. The antiparallel configuration (HFA120EA60) is used for simple series rectifier and high voltage application. The parallel configuration (HFA120FA60) is used for simple parallel rectifier and high current application. The semiconductor in the SOT-227 package is isolated from the copper base plate, allowing for common heatsinks and compact assemblies to be built. These modules are intended for general applications such as power supplies, battery chargers, electronic welders, motor control, DC chopper, and inverters.

PRODUCT SUMMARY

V_R	600 V
V_F (typical) at 125 °C	1.4 V
Q_{rr} (typical)	270 nC
I_{RRM} (typical)	7.0 A
t_{rr} (typical)	65 ns
$di_{(rec)M}/dt$ (typical) at 125 °C	270 A/ μ s
$I_{F(DC)}$ at T_C	40 A at 100 °C

ABSOLUTE MAXIMUM RATINGS PER LEG

PARAMETER	SYMBOL	TEST CONDITIONS	VALUES	UNITS
Cathode to anode voltage	V_R		600	V
Continuous forward current	I_F	$T_C = 25\text{ °C}$	75	A
		$T_C = 100\text{ °C}$	40	
Single pulse forward current	I_{FSM}		TBD	
Maximum repetitive forward current	I_{FRM}		180	
RMS isolation voltage, any terminal to case	V_{ISOL}	$t = 1\text{ minute}$	2500	V
Maximum power dissipation	P_D	$T_C = 25\text{ °C}$	180	W
		$T_C = 100\text{ °C}$	71	
Operating junction and storage temperature range	T_J, T_{Stg}		- 55 to 150	°C

ELECTRICAL SPECIFICATIONS PER LEG ($T_J = 25\text{ °C}$ unless otherwise specified)

PARAMETER	SYMBOL	TEST CONDITIONS	MIN.	TYP.	MAX.	UNITS
Cathode to anode breakdown voltage	V_{BR}	$I_R = 100\text{ }\mu\text{A}$	600	-	-	V
Maximum forward voltage	V_{FM}	$I_F = 60\text{ A}$	-	1.5	1.7	
		$I_F = 120\text{ A}$	-	1.9	2.1	
		$I_F = 60\text{ A}, T_J = 125\text{ °C}$	-	1.4	1.6	
Maximum reverse leakage current	I_{RM}	$V_R = V_R\text{ rated}$	-	2.5	20	μA
		$T_J = 125\text{ °C}, V_R = 0.8 \times V_R\text{ rated}$	-	130	2000	
Junction capacitance	C_T	$V_R = 200\text{ V}$	-	120	170	pF

DYNAMIC RECOVERY CHARACTERISTICS PER LEG (T _J = 25 °C unless otherwise specified)						
PARAMETER	SYMBOL	TEST CONDITIONS	MIN.	TYP.	MAX.	UNITS
Reverse recovery time See fig. 5, 6 and 16	t _{rr}	I _F = 1.0 A, di _F /dt = 200 A/μs, V _R = 30 V	-	34	-	ns
	t _{rr1}	T _J = 25 °C	-	65	98	
	t _{rr2}	T _J = 125 °C	-	130	200	
Peak recovery current See fig. 7 and 8	I _{RRM1}	T _J = 25 °C	-	7.0	13	A
	I _{RRM2}	T _J = 125 °C	-	13	23	
Reverse recovery charge See fig. 9 and 10	Q _{rr1}	T _J = 25 °C	-	270	410	nC
	Q _{rr2}	T _J = 125 °C	-	490	740	
Peak rate of recovery current during t _b See fig. 11 and 12	di _{(rec)M} /dt1	T _J = 25 °C	-	350	-	A/μs
	di _{(rec)M} /dt2	T _J = 125 °C	-	270	-	

THERMAL - MECHANICAL SPECIFICATIONS					
PARAMETER	SYMBOL	MIN.	TYP.	MAX.	UNITS
Junction to case, single leg conducting	R _{thJC}	-	-	0.70	°C/W K/W
Junction to case, both legs conducting		-	-	0.35	
Case to sink, flat, greased surface	R _{thCS}	-	0.05	-	
Weight		-	30	-	g
Mounting torque		-	1.3	-	Nm



HEXFRED®
Ultrafast Soft Recovery
Diode, 60 A

Vishay High Power Products

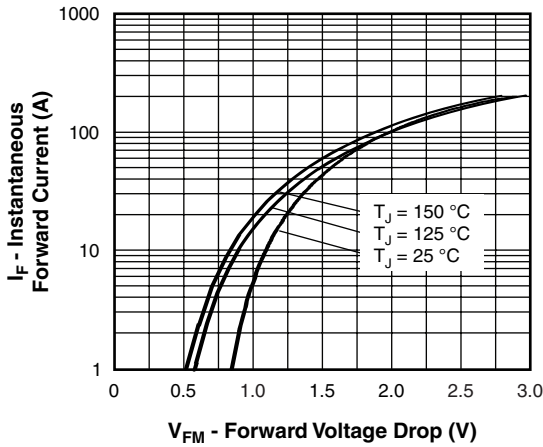

Fig. 1 - Maximum Forward Voltage Drop vs. Instantaneous Forward Current (Per Leg)

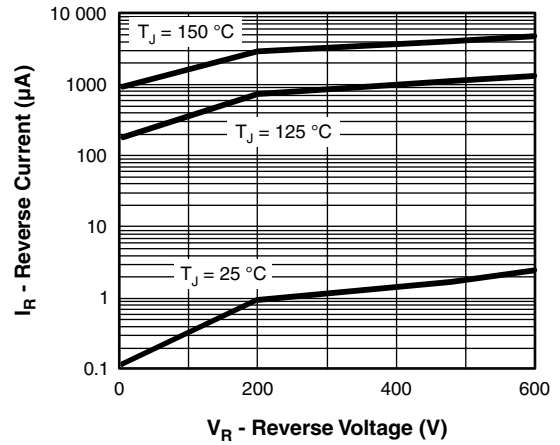

Fig. 2 - Typical Reverse Current vs. Reverse Voltage (Per Leg)

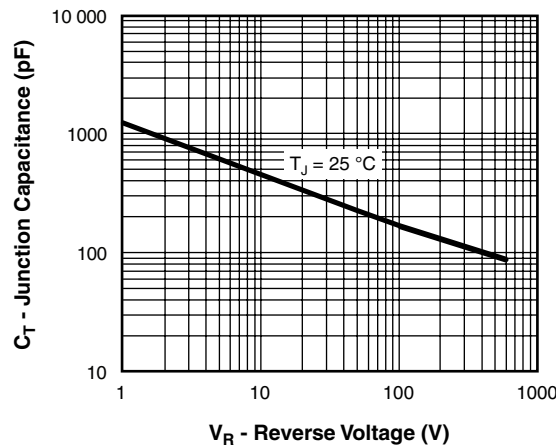

Fig. 3 - Typical Junction Capacitance vs. Reverse Voltage (Per Leg)

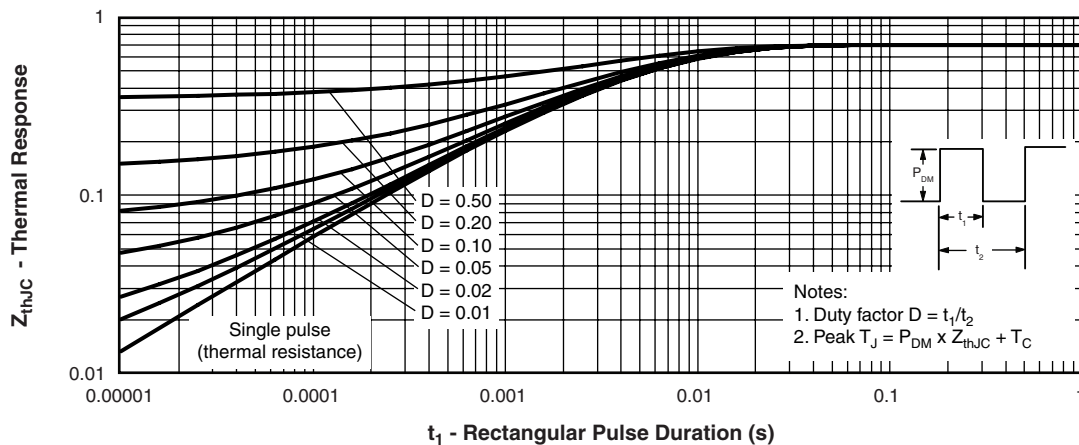

Fig. 4 - Maximum Thermal Impedance Z_{thJC} Characteristics (Per Leg)

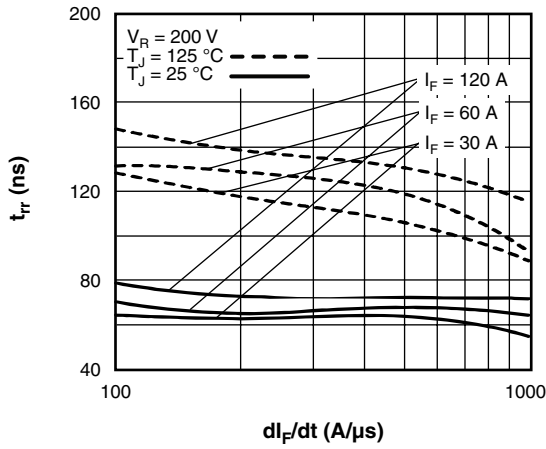

Fig. 5 - Typical Reverse Recovery Time vs. di_F/dt (Per Leg)

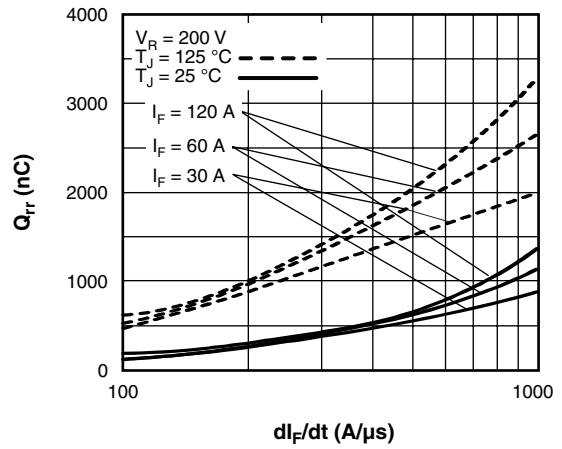

Fig. 7 - Typical Stored Charge vs. di_F/dt (Per Leg)

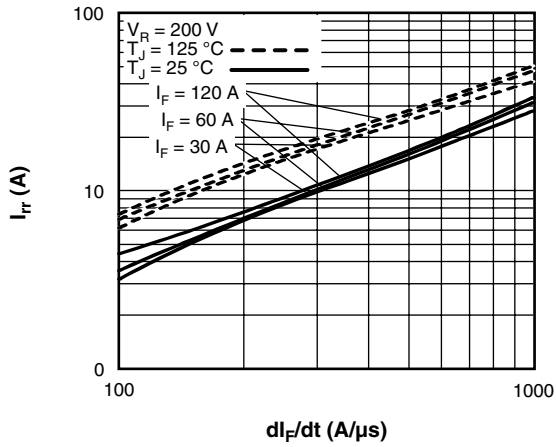

Fig. 6 - Typical Recovery Current vs. di_F/dt (Per Leg)

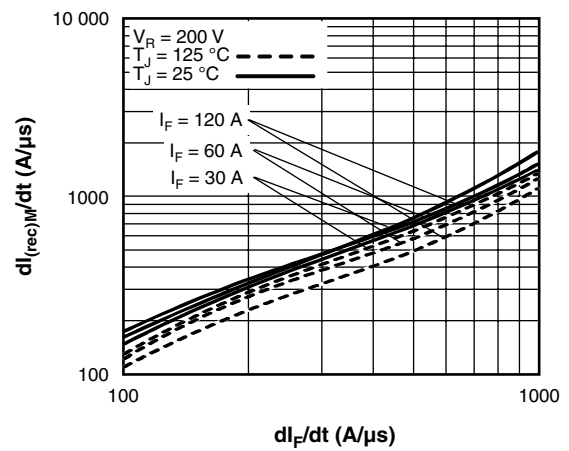

Fig. 8 - Typical $di_{(rec)M}/dt$ vs. di_F/dt (Per Leg)

HEXFRED® Ultrafast Soft Recovery Diode, 60 A

Vishay High Power Products

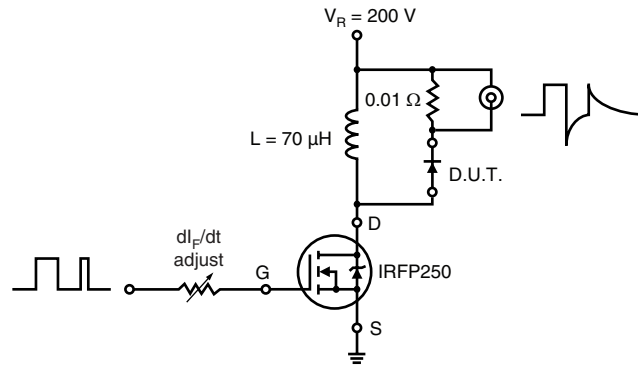
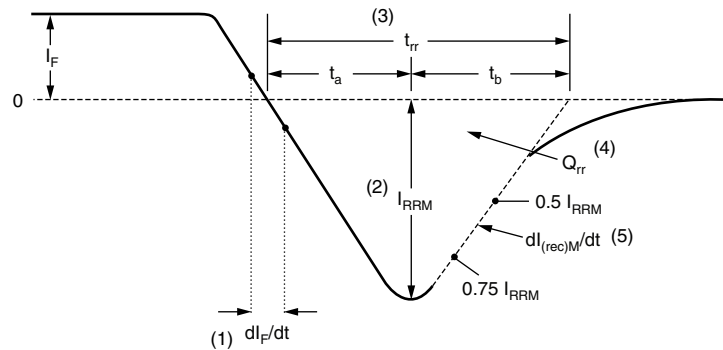

Fig. 9 - Reverse Recovery Parameter Test Circuit



(1) di_F/dt - rate of change of current through zero crossing

(2) I_{RRM} - peak reverse recovery current

(3) t_{rr} - reverse recovery time measured from zero crossing point of negative going I_F to point where a line passing through $0.75 I_{RRM}$ and $0.50 I_{RRM}$ extrapolated to zero current.

(4) Q_{rr} - area under curve defined by t_{rr} and I_{RRM}

$$Q_{rr} = \frac{t_{rr} \times I_{RRM}}{2}$$

(5) $dl_{(rec)M}/dt$ - peak rate of change of current during t_b portion of t_{rr}

Fig. 10 - Reverse Recovery Waveform and Definitions

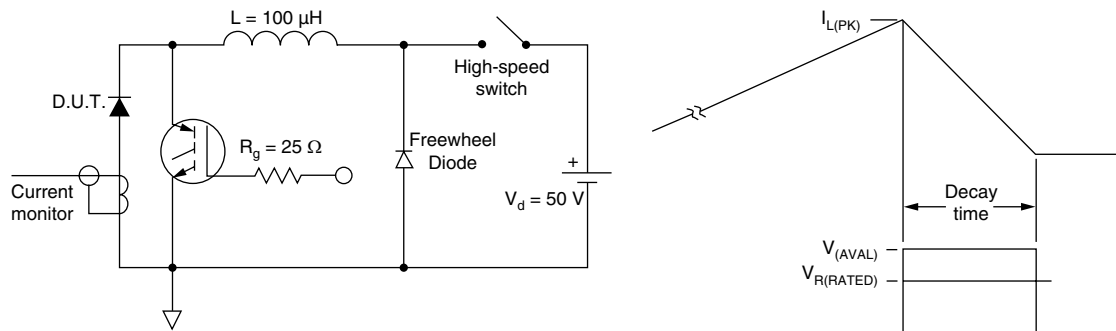

Fig. 11 - Avalanche Test Circuit and Waveforms

HFA120FA60P

Vishay High Power Products

HEXFRED®
Ultrafast Soft Recovery
Diode, 60 A



ORDERING INFORMATION TABLE

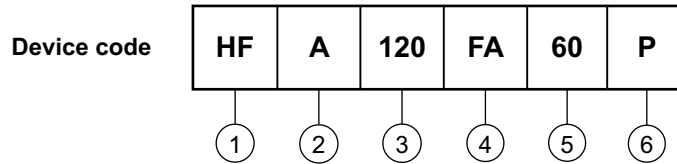

- 1** - HEXFRED® family
- 2** - Process: A electron irradiated
- 3** - Current rating (120 = 120 A)
- 4** - Package indicator (SOT-227)
- 5** - Voltage rating (60 = 600 V)
- 6** - P = Lead (Pb)-free

LINKS TO RELATED DOCUMENTS	
Dimensions	http://www.vishay.com/doc?95036
Packaging information	http://www.vishay.com/doc?95037



Disclaimer

All product specifications and data are subject to change without notice.

Vishay Intertechnology, Inc., its affiliates, agents, and employees, and all persons acting on its or their behalf (collectively, "Vishay"), disclaim any and all liability for any errors, inaccuracies or incompleteness contained herein or in any other disclosure relating to any product.

Vishay disclaims any and all liability arising out of the use or application of any product described herein or of any information provided herein to the maximum extent permitted by law. The product specifications do not expand or otherwise modify Vishay's terms and conditions of purchase, including but not limited to the warranty expressed therein, which apply to these products.

No license, express or implied, by estoppel or otherwise, to any intellectual property rights is granted by this document or by any conduct of Vishay.

The products shown herein are not designed for use in medical, life-saving, or life-sustaining applications unless otherwise expressly indicated. Customers using or selling Vishay products not expressly indicated for use in such applications do so entirely at their own risk and agree to fully indemnify Vishay for any damages arising or resulting from such use or sale. Please contact authorized Vishay personnel to obtain written terms and conditions regarding products designed for such applications.

Product names and markings noted herein may be trademarks of their respective owners.