

$V_R = 600V$
$V_F(\text{typ.})^* = 1.4V$
$I_{F(AV)} = 60A$
$Q_{rr}(\text{typ.}) = 270nC$
$I_{RRM}(\text{typ.}) = 7.0A$
$t_{rr}(\text{typ.}) = 65ns$
$di_{(rec)M}/dt(\text{typ.})^* = 270A/\mu s$

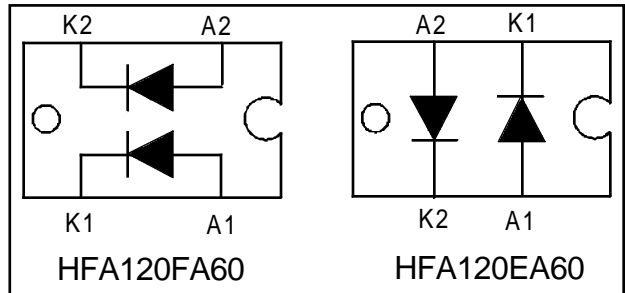

Features

- Fast Recovery time characteristic
- Electrically isolated base plate
- Large creepage distance between terminal
- Simplified mechanical designs, rapid assembly

Description

This SOT-227 modules with FRED rectifier are available in two basic configurations. They are the antiparallel and the parallel configurations. The antiparallel configuration (HFA120EA60) is used for simple series rectifier and high voltage application. The parallel configuration (HFA120FA60) is used for simple parallel rectifier and high current application. The semiconductor in the SOT-227 package is isolated from the copper base plate, allowing for common heatsinks and compact assemblies to be built.

These modules are intended for general applications such as power supplies, battery chargers, electronic welders, motor control, DC chopper, and inverters.

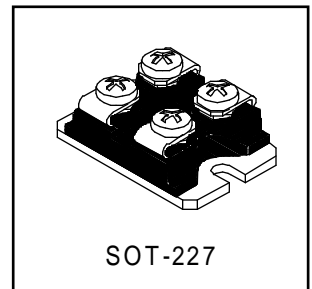

Absolute Maximum Ratings (per Leg)

	Parameter	Max.	Units
V_R	Cathode-to-Anode Voltage	600	V
$I_F @ T_C = 25^\circ C$	Continuous Forward Current	75	A
$I_F @ T_C = 100^\circ C$	Continuous Forward Current	40	
I_{FSM}	Single Pulse Forward Current	TBD	
I_{FRM}	Maximum Repetitive Forward Current	180	
V_{ISOL}	RMS Isolation Voltage, Any Terminal to Case, t=1 min	2500	V
$P_D @ T_C = 25^\circ C$	Maximum Power Dissipation	180	W
$P_D @ T_C = 100^\circ C$	Maximum Power Dissipation	71	
T_J	Operating Junction and	-55 to +150	$^\circ C$
T_{STG}	Storage Temperature Range		

*125 $^\circ C$

Electrical Characteristics (per Leg) @ $T_J = 25^\circ\text{C}$ (unless otherwise specified)

	Parameter	Min.	Typ.	Max.	Units	Test Conditions
V_{BR}	Cathode Anode Breakdown Voltage	600	—	—	V	$I_R = 100\mu\text{A}$
V_{FM}	Max Forward Voltage	—	1.5	1.7	V	$I_F = 60\text{A}$
		—	1.9	2.1		$I_F = 120\text{A}$ See Fig. 1
		—	1.4	1.6		$I_F = 60\text{A}, T_J = 125^\circ\text{C}$
I_{RM}	Max Reverse Leakage Current	—	2.5	20	μA	$V_R = V_R$ Rated See Fig. 2
		—	130	2000		$T_J = 125^\circ\text{C}, V_R = 0.8 \times V_R$ Rated
C_T	Junction Capacitance	—	120	170	pF	$V_R = 200\text{V}$ See Fig. 3

Dynamic Recovery Characteristics (per Leg) @ $T_J = 25^\circ\text{C}$ (unless otherwise specified)

	Parameter	Min.	Typ.	Max.	Units	Test Conditions	
t_{rr}	Reverse Recovery Time	—	34	—	ns	$I_F = 1.0\text{A}, di/dt = 200\text{A}/\mu\text{s}, V_R = 30\text{V}$	
t_{rr1}	See Fig. 5, 6 & 16	—	65	98			$T_J = 25^\circ\text{C}$
t_{rr2}		—	130	200			$T_J = 125^\circ\text{C}$
I_{RRM1}	Peak Recovery Current	—	7.0	13	A	$T_J = 25^\circ\text{C}$	
I_{RRM2}	See Fig. 7 & 8	—	13	23			$T_J = 125^\circ\text{C}$
Q_{rr1}	Reverse Recovery Charge	—	270	410	nC	$T_J = 25^\circ\text{C}$	
Q_{rr2}	See Fig. 9 & 10	—	490	740			$T_J = 125^\circ\text{C}$
$di_{(rec)M}/dt1$	Peak Rate of Fall of Recovery Current	—	350	—	$\text{A}/\mu\text{s}$	$di/dt = 200\text{A}/\mu\text{s}$	
$di_{(rec)M}/dt2$	During t_b See Fig. 11 & 12	—	270	—			$T_J = 125^\circ\text{C}$

Thermal - Mechanical Characteristics

	Parameter	Min.	Typ.	Max.	Units
$R_{\theta JC}$	Junction-to-Case, Single Leg Conducting	—	—	0.70	$^\circ\text{C}/\text{W}$ K/W
	Junction-to-Case, Both Legs Conducting	—	—	0.35	
$R_{\theta CS}$	Case-to-Sink, Flat, Greased Surface	—	0.05	—	
Wt	Weight	—	30	—	gm
	Mounting Torque	—	1.3	—	(N•m)

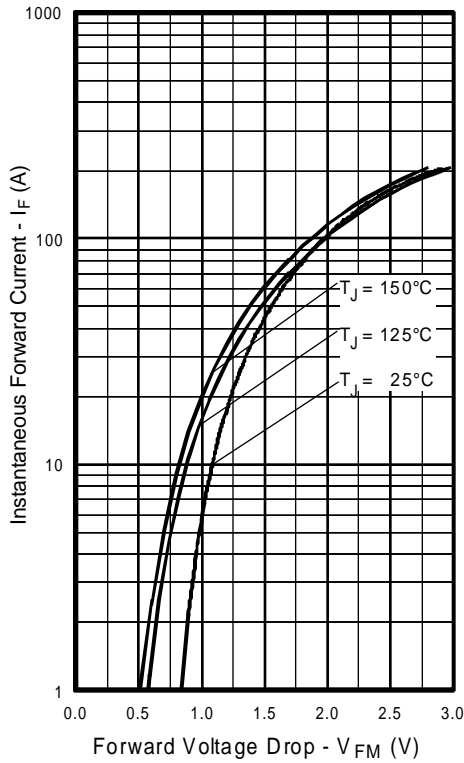

Fig. 1 - Maximum Forward Voltage Drop vs. Instantaneous Forward Current, (per Leg)

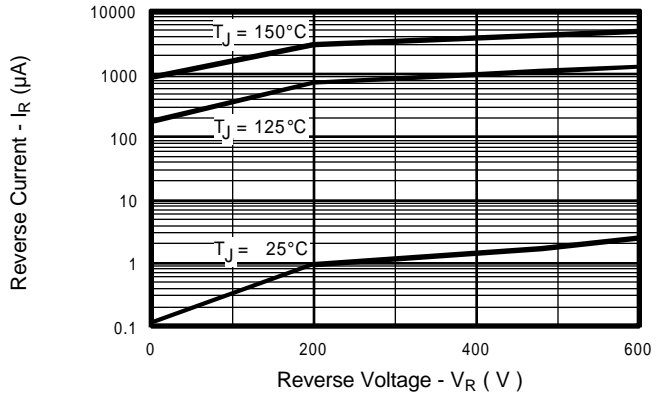

Fig. 2 - Typical Reverse Current vs. Reverse Voltage, (per Leg)

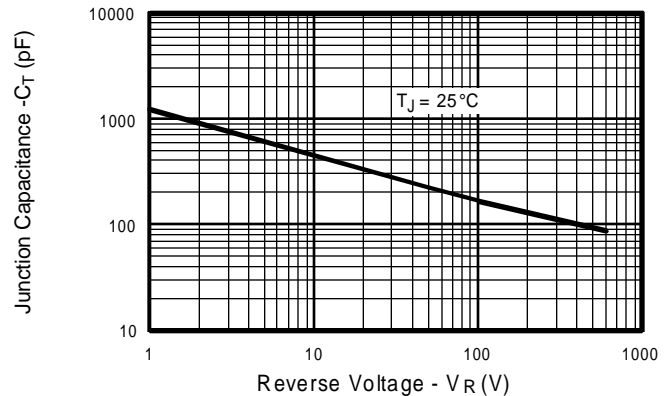

Fig. 3 - Typical Junction Capacitance vs. Reverse Voltage, (per Leg)

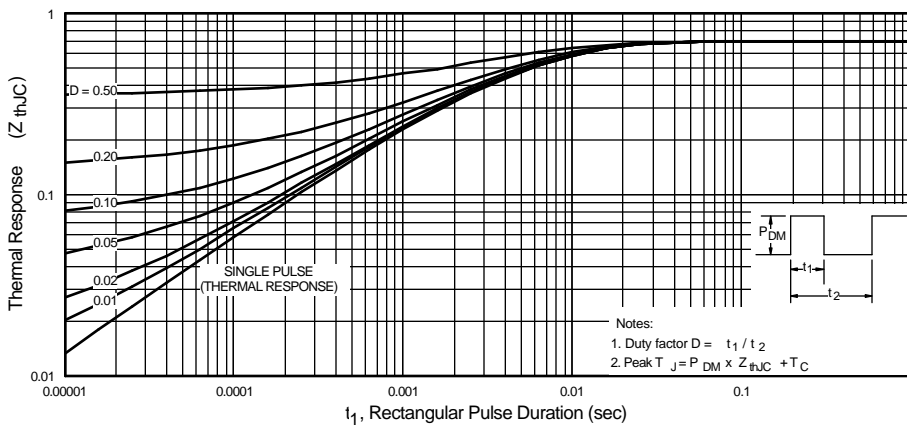

Fig. 4 - Maximum Thermal Impedance Z_{thJC} Characteristics, (per Leg)

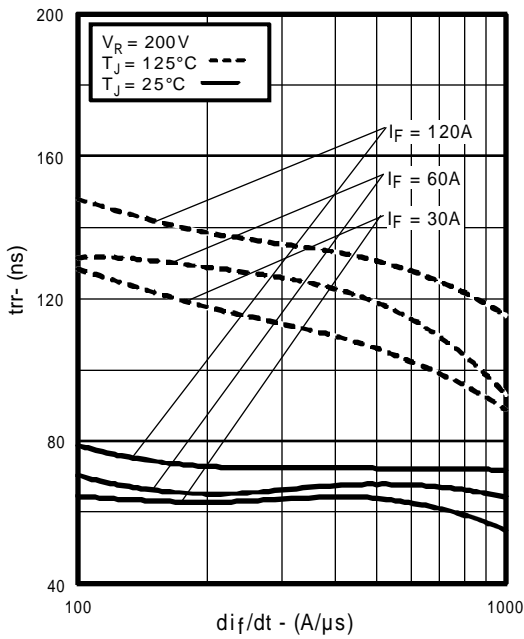

Fig. 5 - Typical Reverse Recovery vs. di_f/dt , (per Leg)

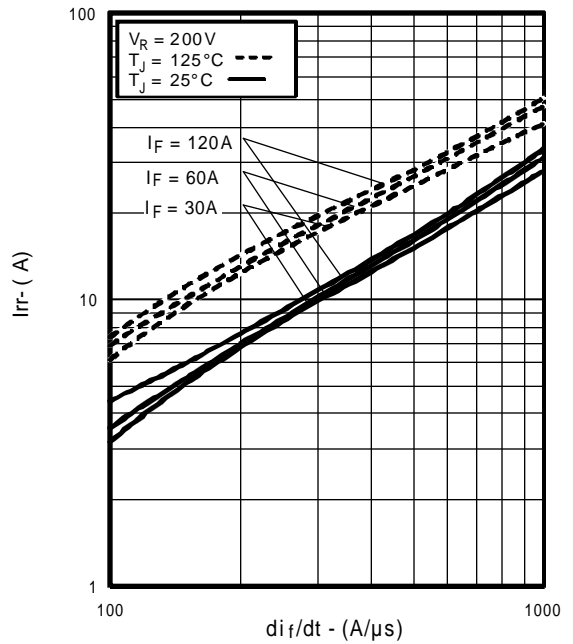

Fig. 6 - Typical Recovery Current vs. di_f/dt , (per Leg)

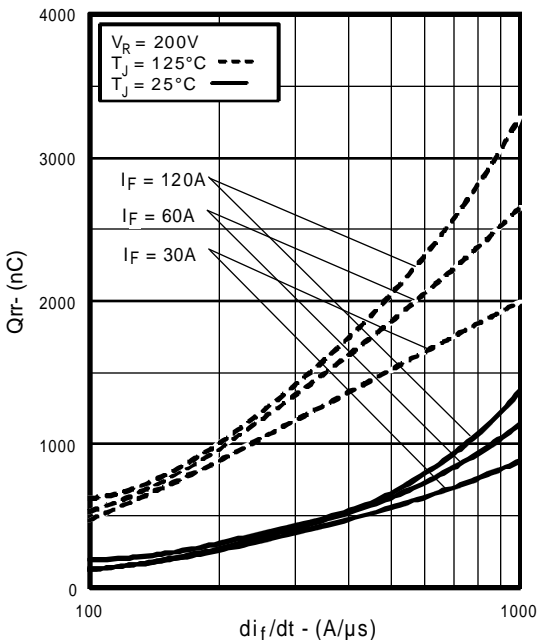

Fig. 7 - Typical Stored Charge vs. di_f/dt , (per Leg)

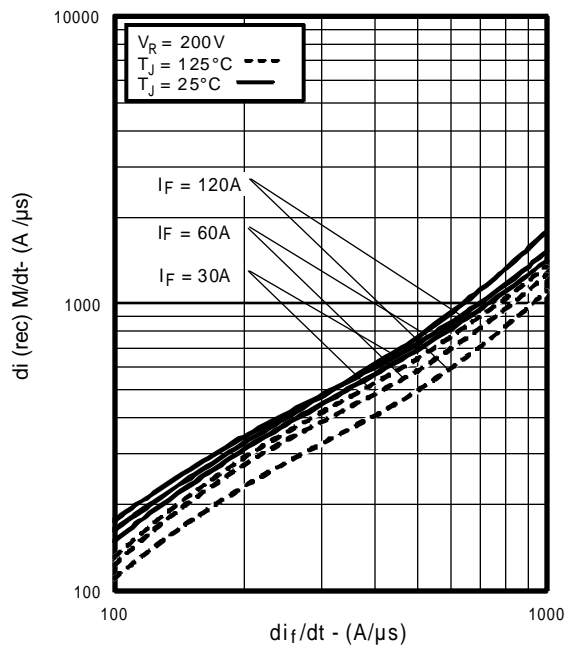

Fig. 8 - Typical $di_{(rec)}M/dt$ vs. di_f/dt , (per Leg)

REVERSE RECOVERY CIRCUIT

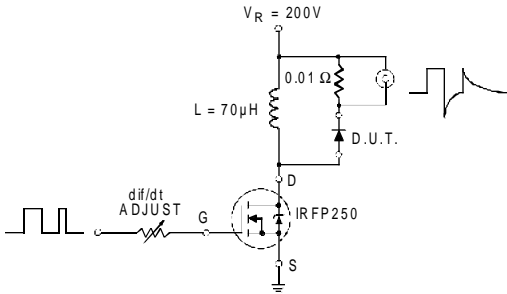
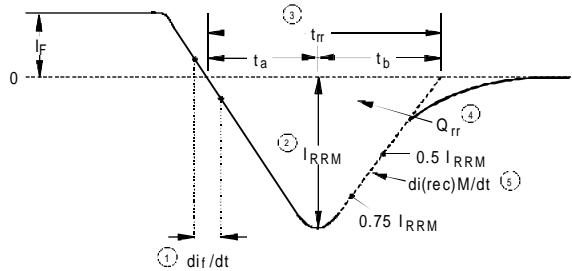

Fig. 9 - Reverse Recovery Parameter Test Circuit



1. di/dt - Rate of change of current through zero crossing
2. I_{RRM} - Peak reverse recovery current
3. t_{rr} - Reverse recovery time measured from zero crossing point of negative going I_F to point where a line passing through $0.75 I_{RRM}$ and $0.50 I_{RRM}$ extrapolated to zero current
4. Q_{rr} - Area under curve defined by t_{rr} and I_{RRM}

$$Q_{rr} = \frac{t_{rr} \times I_{RRM}}{2}$$
5. $di_{(rec)M}/dt$ - Peak rate of change of current during t_b portion of t_{rr}

Fig. 10 - Reverse Recovery Waveform and Definitions

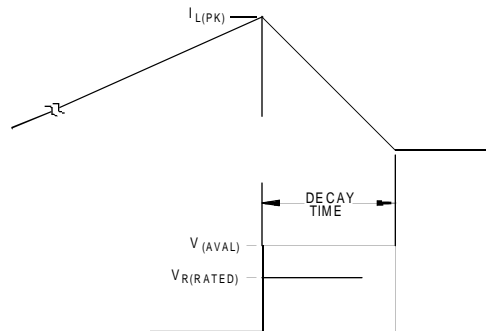
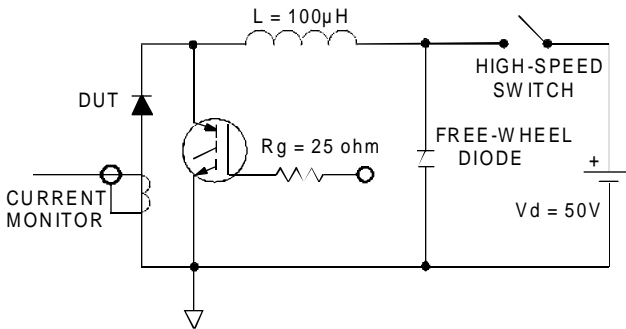
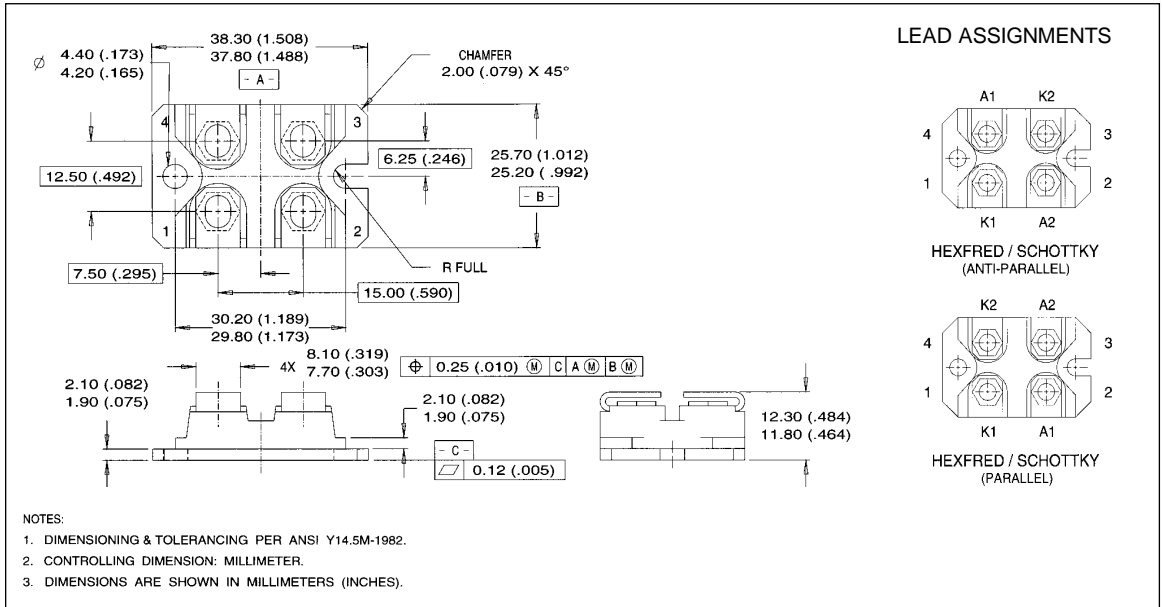

Fig. 11 - Avalanche Test Circuit and Waveforms

HFA120FA60, HFA120EA60

SOT-227 Package Details



Tube

QUANTITIES PER TUBE IS 10
M4 SREW AND WASHER INCLUDED

