

HD74LVC2G66

2-channel Analog Switch

REJ03D0024-0300

Rev.3.00

Jul.07.2005

Description

The HD74LVC2G66 has 2-channel analog switch in an 8-pin package. Each switch section has its own enable input control ($\overline{\text{CONT}}$). High-level voltage applied to CONT turns on associated switch section. Low voltage and high-speed operation is suitable for the battery powered products (e.g., notebook computers), and the low power consumption extends the battery life.

Features

- The basic gate function is lined up as renesas uni logic series.
- Supply voltage range: 1.65 to 5.5 V
- Operating temperature range: -40 to +85°C
- Control inputs: $V_{IH}(\text{Max.}) = 5.5 \text{ V}$ (@ $V_{CC} = 0 \text{ V}$ to 5.5 V)
- Ordering Information

Part Name	Package Type	Package Code (Previous Code)	Package Abbreviation	Taping Abbreviation (Quantity)
HD74LVC2G66CPE	WCSP-8 pin	SXBG0008KA-A (TBS-8V)	CP	E (3,000 pcs/reel)
HD74LVC2G66CLE		SXBG0008KB-A (TBS-8AV)	CL	

Article Indication

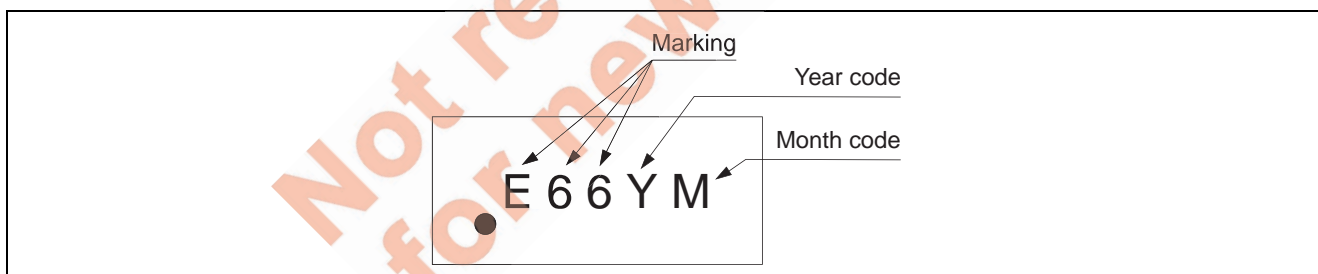

Function Table

Control	Switch
L	OFF
H	ON

H : High level

L : Low level

Pin Arrangement

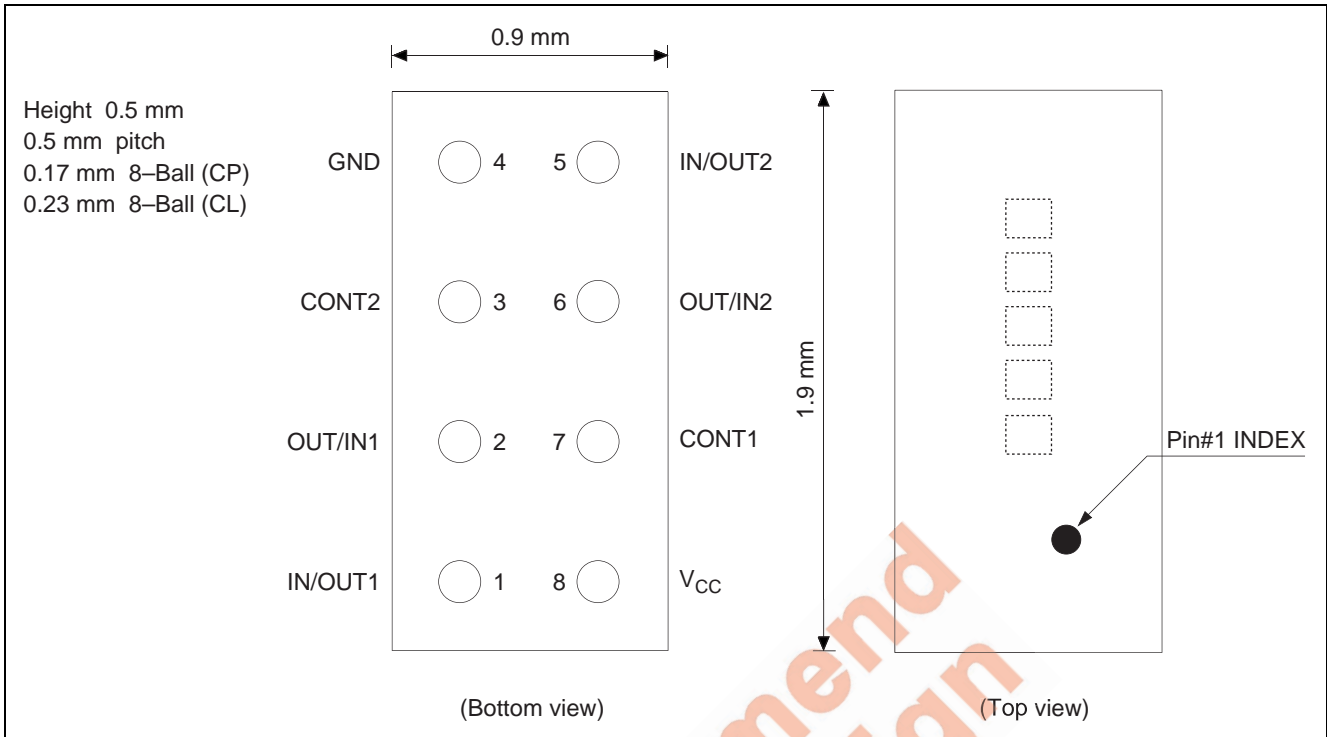

Logic Diagram

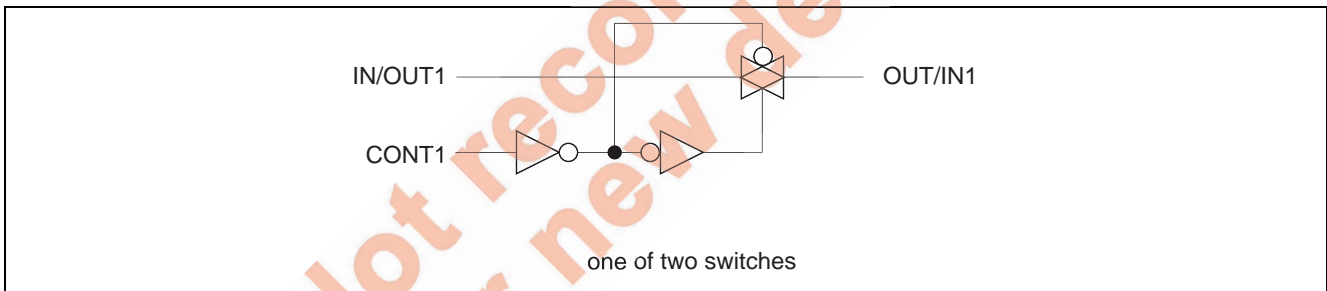

Absolute Maximum Ratings

Item	Symbol	Ratings	Unit	Test Conditions
Supply voltage range	V_{CC}	-0.5 to 6.5	V	
Input voltage range ^{*1}	V_I	-0.5 to 6.5	V	
Output voltage range ^{*1,2}	V_O	-0.5 to $V_{CC} + 0.5$	V	Output : H or L
Input clamp current	I_{IK}	-50	mA	$V_I < 0$
Output clamp current	I_{OK}	-50	mA	$V_O < 0$
Continuous output current	I_O	± 50	mA	$V_O = 0$ to V_{CC}
Continuous current through V_{CC} or GND	I_{CC} or I_{GND}	± 100	mA	
Package Thermal impedance	θ_{ja}	140	$^{\circ}C/W$	CP
		102		CL
Storage temperature	T_{stg}	-65 to 150	$^{\circ}C$	

Notes: The absolute maximum ratings are values, which must not individually be exceeded, and furthermore no two of which may be realized at the same time.

1. The input and output voltage ratings may be exceeded if the input and output clamp-current ratings are observed.
2. This value is limited to 5.5 V maximum.

Recommended Operating Conditions

Item	Symbol	Min	Max	Unit	Conditions
Supply voltage range	V_{CC}	1.65	5.5	V	
Input voltage range	V_I	0	5.5	V	
Output voltage range	V_O	0	V_{CC}	V	
Input transition rise or fall rate	$\Delta t / \Delta v$	0	20	ns / V	$V_{CC} = 1.65$ to 1.95 V, 2.3 to 2.7 V
		0	10		$V_{CC} = 3.0$ to 3.6 V
		0	10		$V_{CC} = 4.5$ to 5.5 V
Operating free-air temperature	T_a	-40	85	°C	

Note: Unused or floating inputs must be held high or low.

Not recommend
for new design

Electrical Characteristics

- Ta = -40 to 85°C

Item	Symbol	V _{CC} (V)	Min	Typ	Max	Unit	Test condition
Input voltage	V _{IH}	1.65 to 1.95	V _{CC} ×0.65	—	—	V	
		2.3 to 2.7	V _{CC} ×0.7	—	—		
		3.0 to 3.6	V _{CC} ×0.7	—	—		
		4.5 to 5.5	V _{CC} ×0.7	—	—		
	V _{IL}	1.65 to 1.95	—	—	V _{CC} ×0.35		
		2.3 to 2.7	—	—	V _{CC} ×0.3		
		3.0 to 3.6	—	—	V _{CC} ×0.3		
		4.5 to 5.5	—	—	V _{CC} ×0.3		
On-state switch resistance	R _{ON}	1.65	—	12.5	30	Ω	I _S = 4 mA I _S = 8 mA I _S = 24 mA I _S = 32 mA V _I =V _{CC} or GND
		2.3	—	9	20		
		3.0	—	7.5	15		
		4.5	—	6	10		
Peak on resistance	R _{ON(P)}	1.65	—	85	120		I _S = 4 mA I _S = 8 mA I _S = 24 mA I _S = 32 mA V _I =V _{CC} to GND
		2.3	—	22	30		
		3.0	—	12	20		
		4.5	—	7.5	15		
Difference of on-state resistance between switches	ΔR _{ON}	1.65	—	—	7		I _S = 4 mA I _S = 8 mA I _S = 24 mA I _S = 32 mA V _I =V _{CC} to GND
		2.3	—	—	5		
		3.0	—	—	3		
		4.5	—	—	2		
Off-state switch leakage current	I _{S(OFF)}	5.5	—	—	±1.0	μA	V _I = V _{CC} and V _O = GND or V _I = GND and V _O = V _{CC} , V _C = V _{IL}
			—	—	±0.1*1		
On-state switch leakage current	I _{S(ON)}	5.5	—	—	±1.0	μA	V _I = V _{CC} or GND, V _C = V _{IH} V _O = Open
			—	—	±0.1*1		
Control input current	I _{IN}	5.5	—	—	±1.0	μA	V _{IN} = V _{CC} or GND
			—	—	±0.1*1		
Quiescent supply current	I _{CC}	5.5	—	—	10	μA	V _{IN} = V _{CC} or GND
			—	—	1.0*1		
	ΔI _{CC}	5.5	—	—	500	μA	V _C = V _{CC} -0.6 V
Control input capacitance	C _{IC}	5.0	—	3.5	—	pF	
Switch terminal capacitance	C _{I/O(OFF)}	5.0	—	6.0	—	pF	
	C _{I/O(ON)}	5.0	—	14.0	—		

Note: 1. Ta = 25°C

Switching Characteristics

- $V_{CC} = 1.8 \pm 0.15 \text{ V}$

Item	Symbol	Ta = -40 to 85°C		Unit	Test Conditions	FROM (Input)	TO (Output)
		Min	Max				
Propagation delay time*1	t _{PLH} , t _{PHL}	—	2.0	ns	C _L = 30 pF, R _L = 1.0 kΩ	INOUT or OUTIN	OUTIN or INOUT
Enable time	t _{ZH} , t _{ZL}	2.3	10.0				
Disable time	t _{HZ} , t _{LZ}	2.5	10.5				

- $V_{CC} = 2.5 \pm 0.2 \text{ V}$

Item	Symbol	Ta = -40 to 85°C		Unit	Test Conditions	FROM (Input)	TO (Output)
		Min	Max				
Propagation delay time*1	t _{PLH} , t _{PHL}	—	1.2	ns	C _L = 30 pF, R _L = 500 Ω	INOUT or OUTIN	OUTIN or INOUT
Enable time	t _{ZH} , t _{ZL}	1.6	5.6				
Disable time	t _{HZ} , t _{LZ}	1.2	6.9				

- $V_{CC} = 3.3 \pm 0.3 \text{ V}$

Item	Symbol	Ta = -40 to 85°C		Unit	Test Conditions	FROM (Input)	TO (Output)
		Min	Max				
Propagation delay time*1	t _{PLH} , t _{PHL}	—	0.8	ns	C _L = 50 pF, R _L = 500 Ω	INOUT or OUTIN	OUTIN or INOUT
Enable time	t _{ZH} , t _{ZL}	1.5	4.4				
Disable time	t _{HZ} , t _{LZ}	2.0	7.2				

- $V_{CC} = 5.0 \pm 0.5 \text{ V}$

Item	Symbol	Ta = -40 to 85°C		Unit	Test Conditions	FROM (Input)	TO (Output)
		Min	Max				
Propagation delay time*1	t _{PLH} , t _{PHL}	—	0.6	ns	C _L = 50 pF, R _L = 500 Ω	INOUT or OUTIN	OUTIN or INOUT
Enable time	t _{ZH} , t _{ZL}	1.3	3.9				
Disable time	t _{HZ} , t _{LZ}	1.1	6.3				

Notes: 1. The propagation delay is calculated RC time constant of typical on-state resistance of the switch and the specified load capacitance, when driven by an ideal voltage source (zero output impedance).

Analog Switch Characteristics

Item	V _{CC} (V)	Ta = 25°C			Unit	Test conditions	FROM (Input)	TO (Output)
		Min	Typ	Max				
Frequency response (Switch ON)	1.65	—	35	—	MHz	C _L = 50 pF, R _L = 600 Ω Adjust fin voltage to obtain 0dBm at output when fin is 1MHz (sine wave).	INOUT or OUTIN	OUTIN or INOUT
	2.3	—	120	—				
	3.0	—	175	—				
	4.5	—	195	—				
	1.65	—	>300	—		C _L = 5 pF, R _L = 50 Ω Increase fin frequency until the dB-meter reads -3 dBm. 20 log(V _O /V _I) = -3 dBm		
	2.3	—	>300	—				
	3.0	—	>300	—				
	4.5	—	>300	—				
Crosstalk (between switches)	1.65	—	-58	—	dB	C _L = 50 pF, R _L = 600 Ω Adjust fin voltage to obtain 0dBm at input when fin is 1MHz (sine wave).	INOUT or OUTIN	OUTIN or INOUT
	2.3	—	-58	—				
	3.0	—	-58	—				
	4.5	—	-58	—				
	1.65	—	-42	—		C _L = 5 pF, R _L = 50 Ω		
	2.3	—	-42	—				
	3.0	—	-42	—				
	4.5	—	-42	—				
Crosstalk (Control input to signal output)	1.65	—	35	—	mV	C _L = 50 pF, R _L = 600 Ω Adjust RL value to obtain 0A at I _{IN/OUT} when fin is 1MHz (square wave)	CONT	OUTIN or INOUT
	2.3	—	50	—				
	3.0	—	70	—				
	4.5	—	100	—				
Feed through attenuation (Switch OFF)	1.65	—	-58	—	dB	C _L = 50 pF, R _L = 600 Ω Adjust fin voltage to obtain 0dBm at input when fin is 1MHz (sine-wave)	INOUT or OUTIN	OUTIN or INOUT
	2.3	—	-58	—				
	3.0	—	-58	—				
	4.5	—	-58	—				
	1.65	—	-42	—		C _L = 5 pF, R _L = 50 Ω		
	2.3	—	-42	—				
	3.0	—	-42	—				
	4.5	—	-42	—				
Sine-wave distortion	1.65	—	0.1	—	%	C _L = 50 pF, R _L = 10 kΩ fin = 1kHz (sine-wave) V _I =1.4V _{p-p} , V _{CC} =1.65V V _I =2.0V _{p-p} , V _{CC} =2.3V V _I =2.5V _{p-p} , V _{CC} =3.0V V _I =4.0V _{p-p} , V _{CC} =4.5V	INOUT or OUTIN	OUTIN or INOUT
	2.3	—	0.025	—				
	3.0	—	0.015	—				
	4.5	—	0.01	—				
	1.65	—	0.15	—		C _L = 50 pF, R _L = 10 kΩ fin = 10kHz (sine-wave)		
	2.3	—	0.025	—				
	3.0	—	0.015	—				
	4.5	—	0.01	—				

Operating Characteristics

Item	Symbol	V _{CC} (V)	Ta = 25°C			Unit	Test Conditions
			Min	Typ	Max		
Power dissipation capacitance	C _{PD}	1.8	—	8	—	pF	f = 10 MHz
		2.5	—	9	—		
		3.3	—	9.5	—		
		5.0	—	11	—		

Test Circuit

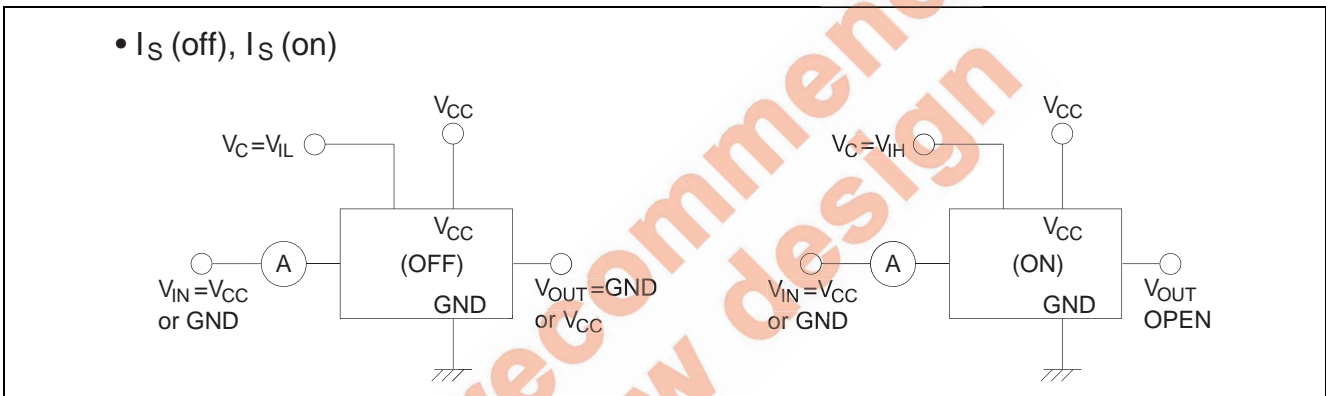
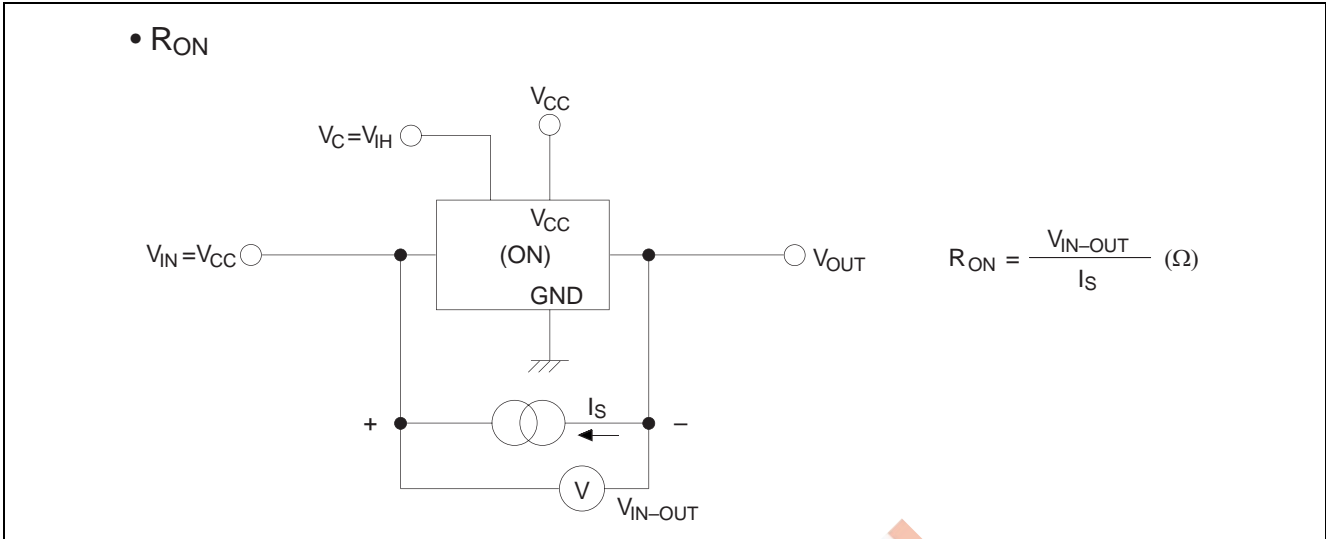

Not recommended for new design

Test Circuit (cont.)

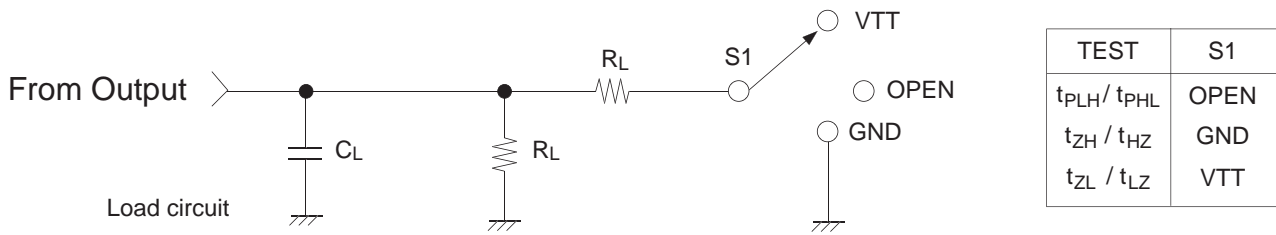

V_{CC} (V)	INPUTS		V_{ref}	VTT	C_L	R_L	ΔV
	V_I	t_r / t_f					
1.8 ± 0.15	V_{CC}	≤ 2 ns	$V_{CC} / 2$	$2 \times V_{CC}$	30 pF	1.0 k Ω	0.15 V
2.5 ± 0.2	V_{CC}	≤ 2 ns	$V_{CC} / 2$	$2 \times V_{CC}$	30 pF	500 Ω	0.15 V
3.3 ± 0.3	V_{CC}	≤ 2.5 ns	$V_{CC} / 2$	$2 \times V_{CC}$	50 pF	500 Ω	0.3 V
5.0 ± 0.5	V_{CC}	≤ 2.5 ns	$V_{CC} / 2$	$2 \times V_{CC}$	50 pF	500 Ω	0.3 V

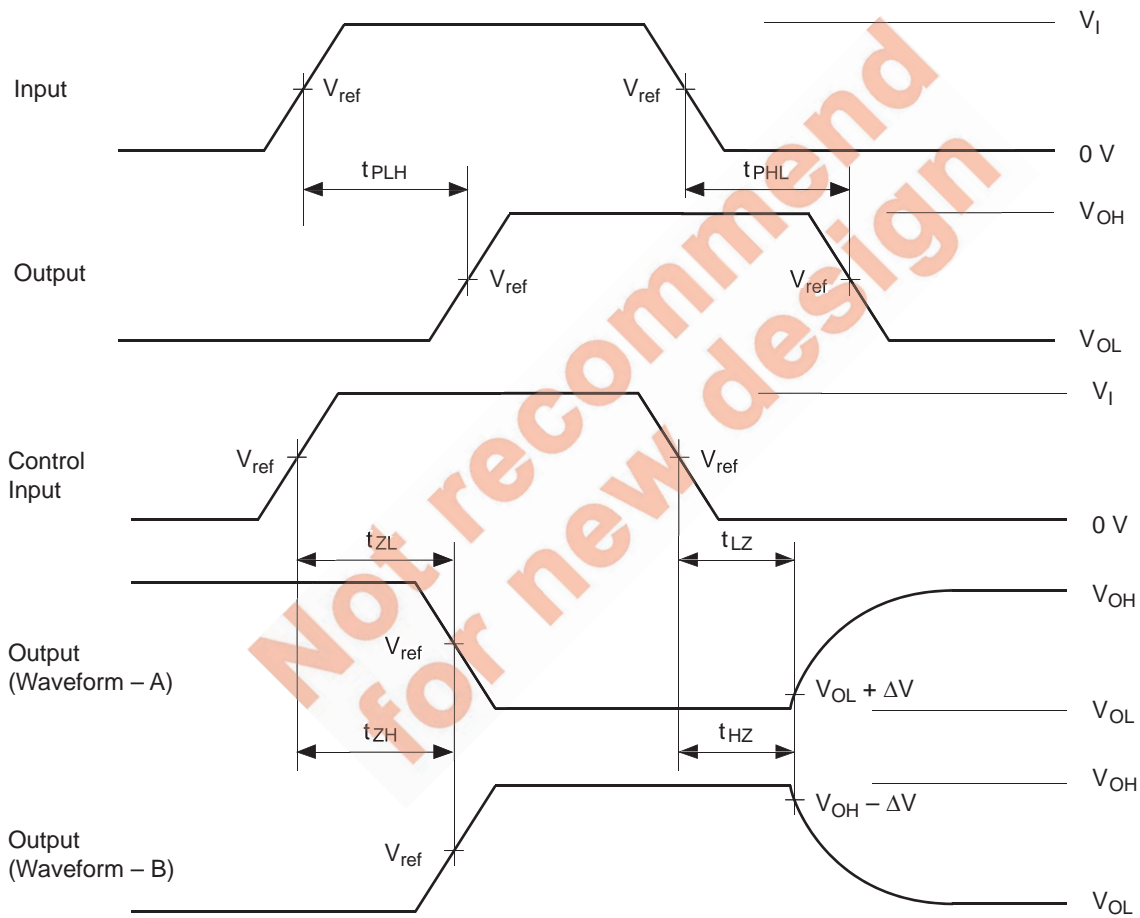

- Notes:
- C_L includes probe and jig capacitance.
 - Waveform-A is for an output with internal conditions such that the output is low except when disabled by the output control.
 - Waveform-B is for an output with internal conditions such that the output is high except when disabled by the output control.
 - All input pulses are supplied by generators having the following characteristics:
 $PRR \leq 10\text{MHz}$, $Z_o = 50 \Omega$.
 - The output are measured one at a time with one transition per measurement.

Frequency response (Switch ON)

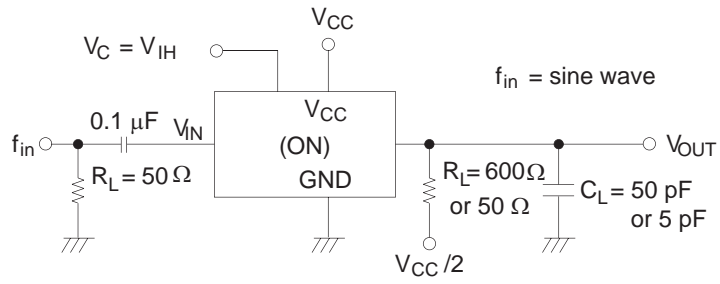

Crosstalk (Between any switches)

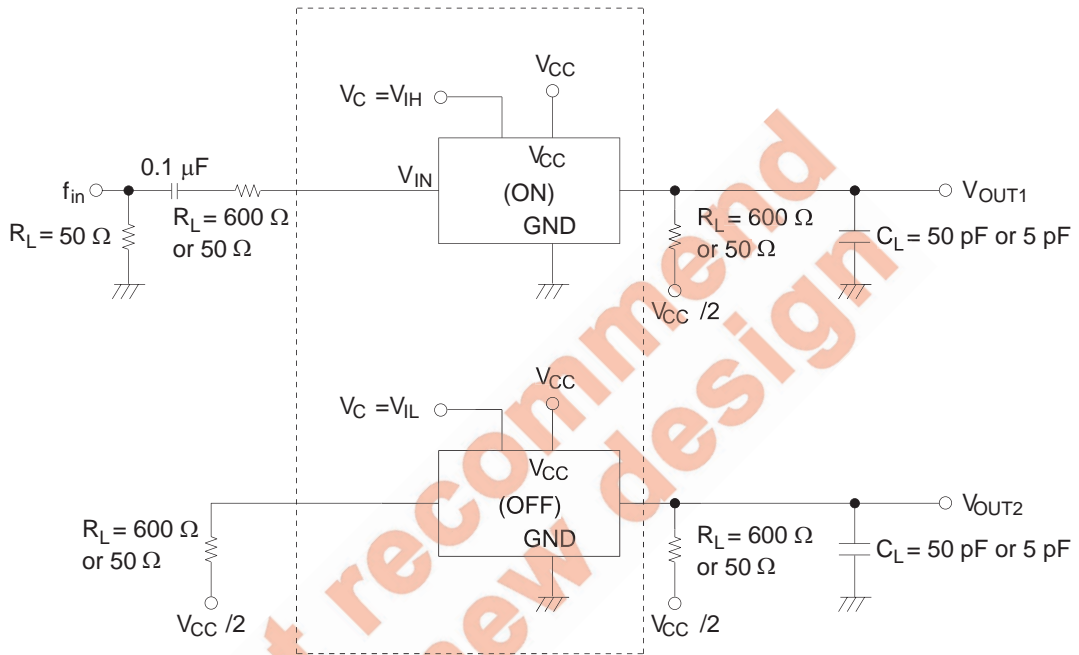

Not recommended for new designs

Crosstalk (Control input to signal output)

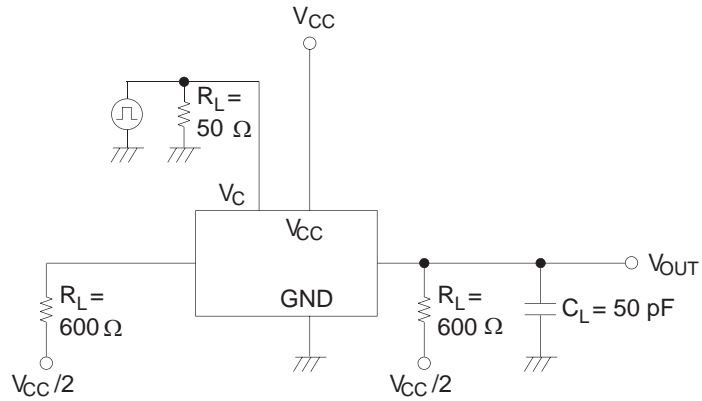

Feedthrough attenuation (Switch OFF)

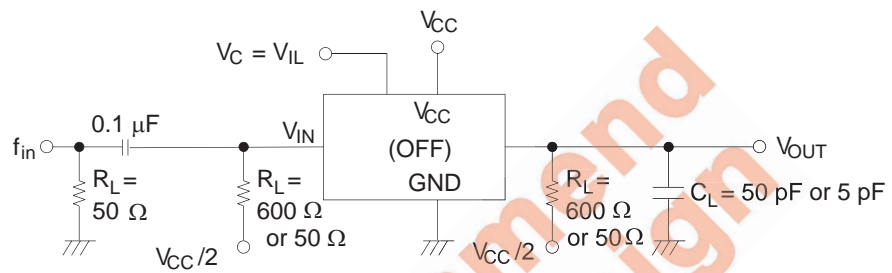

Sine-wave distortion

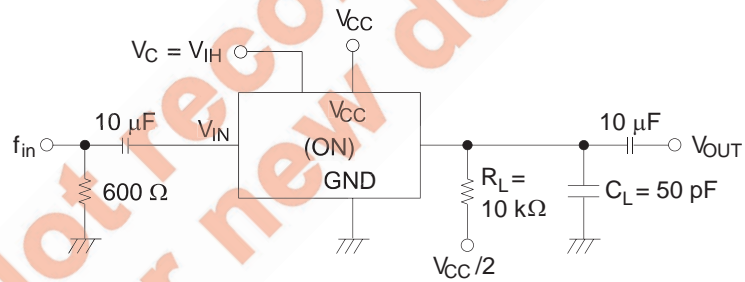

Package Dimensions

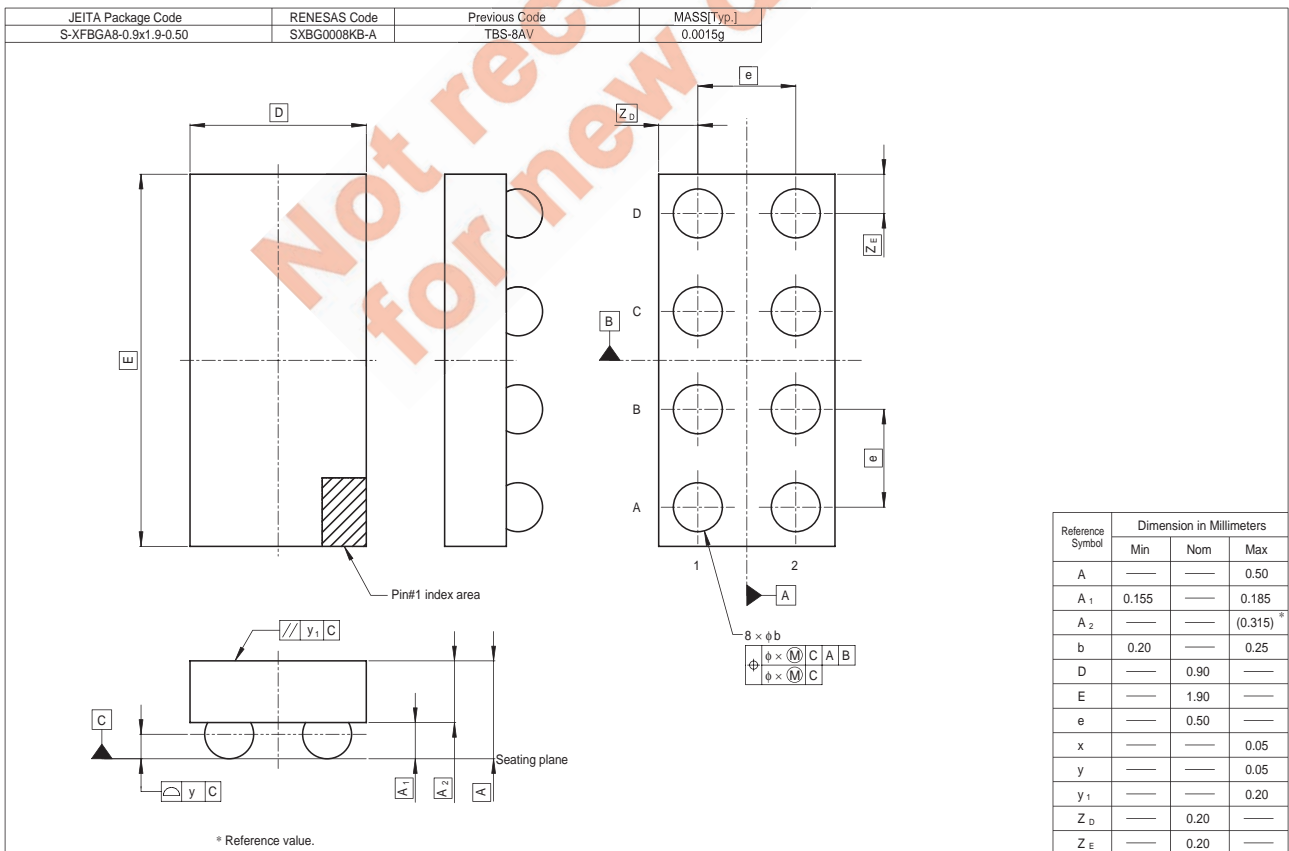
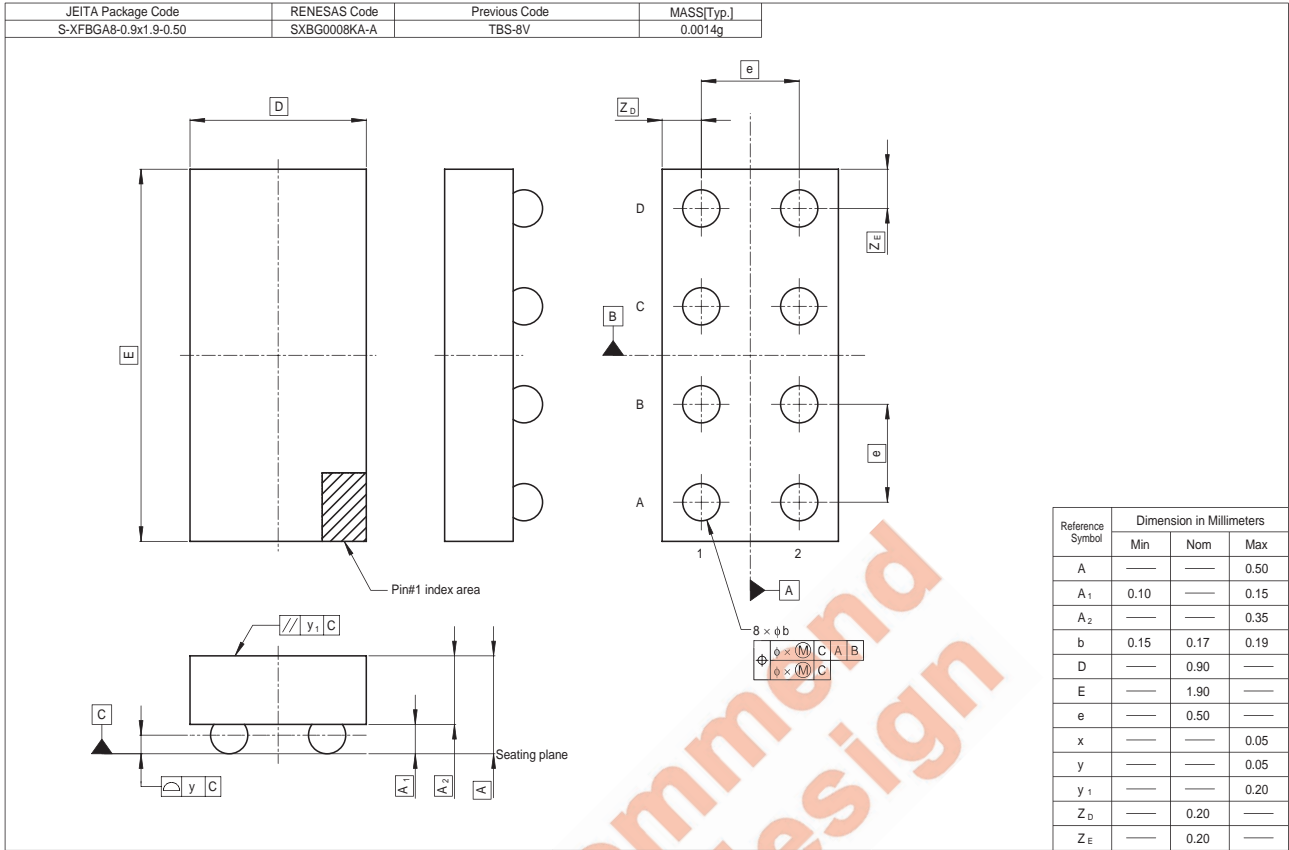

Renesas Technology Corp. Sales Strategic Planning Div. Nippon Bldg., 2-6-2, Ohte-machi, Chiyoda-ku, Tokyo 100-0004, Japan

Keep safety first in your circuit designs!

1. Renesas Technology Corp. puts the maximum effort into making semiconductor products better and more reliable, but there is always the possibility that trouble may occur with them. Trouble with semiconductors may lead to personal injury, fire or property damage. Remember to give due consideration to safety when making your circuit designs, with appropriate measures such as (i) placement of substitutive, auxiliary circuits, (ii) use of nonflammable material or (iii) prevention against any malfunction or mishap.

Notes regarding these materials

1. These materials are intended as a reference to assist our customers in the selection of the Renesas Technology Corp. product best suited to the customer's application; they do not convey any license under any intellectual property rights, or any other rights, belonging to Renesas Technology Corp. or a third party.
2. Renesas Technology Corp. assumes no responsibility for any damage, or infringement of any third-party's rights, originating in the use of any product data, diagrams, charts, programs, algorithms, or circuit application examples contained in these materials.
3. All information contained in these materials, including product data, diagrams, charts, programs and algorithms represents information on products at the time of publication of these materials, and are subject to change by Renesas Technology Corp. without notice due to product improvements or other reasons. It is therefore recommended that customers contact Renesas Technology Corp. or an authorized Renesas Technology Corp. product distributor for the latest product information before purchasing a product listed herein.
The information described here may contain technical inaccuracies or typographical errors.
Renesas Technology Corp. assumes no responsibility for any damage, liability, or other loss rising from these inaccuracies or errors.
Please also pay attention to information published by Renesas Technology Corp. by various means, including the Renesas Technology Corp. Semiconductor home page (<http://www.renesas.com>).
4. When using any or all of the information contained in these materials, including product data, diagrams, charts, programs, and algorithms, please be sure to evaluate all information as a total system before making a final decision on the applicability of the information and products. Renesas Technology Corp. assumes no responsibility for any damage, liability or other loss resulting from the information contained herein.
5. Renesas Technology Corp. semiconductors are not designed or manufactured for use in a device or system that is used under circumstances in which human life is potentially at stake. Please contact Renesas Technology Corp. or an authorized Renesas Technology Corp. product distributor when considering the use of a product contained herein for any specific purposes, such as apparatus or systems for transportation, vehicular, medical, aerospace, nuclear, or undersea repeater use.
6. The prior written approval of Renesas Technology Corp. is necessary to reprint or reproduce in whole or in part these materials.
7. If these products or technologies are subject to the Japanese export control restrictions, they must be exported under a license from the Japanese government and cannot be imported into a country other than the approved destination.
Any diversion or reexport contrary to the export control laws and regulations of Japan and/or the country of destination is prohibited.
8. Please contact Renesas Technology Corp. for further details on these materials or the products contained therein.



RENEASAS SALES OFFICES

<http://www.renesas.com>

Refer to "<http://www.renesas.com/en/network>" for the latest and detailed information.

Renesas Technology America, Inc.

450 Holger Way, San Jose, CA 95134-1368, U.S.A
Tel: <1> (408) 382-7500, Fax: <1> (408) 382-7501

Renesas Technology Europe Limited

Dukes Meadow, Millboard Road, Bourne End, Buckinghamshire, SL8 5FH, U.K.
Tel: <44> (1628) 585-100, Fax: <44> (1628) 585-900

Renesas Technology Hong Kong Ltd.

7th Floor, North Tower, World Finance Centre, Harbour City, 1 Canton Road, Tsimshatsui, Kowloon, Hong Kong
Tel: <852> 2265-6688, Fax: <852> 2730-6071

Renesas Technology Taiwan Co., Ltd.

10th Floor, No.99, Fushing North Road, Taipei, Taiwan
Tel: <886> (2) 2715-2888, Fax: <886> (2) 2713-2999

Renesas Technology (Shanghai) Co., Ltd.

Unit2607 Ruijing Building, No.205 Maoming Road (S), Shanghai 200020, China
Tel: <86> (21) 6472-1001, Fax: <86> (21) 6415-2952

Renesas Technology Singapore Pte. Ltd.

1 Harbour Front Avenue, #06-10, Keppel Bay Tower, Singapore 098632
Tel: <65> 6213-0200, Fax: <65> 6278-8001

Renesas Technology Korea Co., Ltd.

Kukje Center Bldg. 18th Fl., 191, 2-ka, Hangang-ro, Yongsan-ku, Seoul 140-702, Korea
Tel: <82> 2-796-3115, Fax: <82> 2-796-2145

Renesas Technology Malaysia Sdn. Bhd.

Unit 906, Block B, Menara Amcorp, Amcorp Trade Centre, No.18, Jalan Persiaran Barat, 46050 Petaling Jaya, Selangor Darul Ehsan, Malaysia
Tel: <603> 7955-9390, Fax: <603> 7955-9510