HD74HC595

8-bit Shift Register/Latch (with 3-state outputs)

HITACHI

Description



This device each contains an 8-bit serial-in, parallel-out shift register that feeds an 8-bit D-type storage register. The storage register has parallel 3-state outputs. Separate clocks are provided for both the shift register and the storage register. The shift register has a direct-overriding clear, serial input, and serial output pins for cascading.

Both the shift register and storage register clocks are positive-edge triggered. If the user wishes to connect both clocks together, the shift register state will always be one clock pulse ahead of the storage register.

Features

- High Speed Operation: t_{pd} (RCK to Q) = 17 ns typ ($C_L = 50$ pF)
- High Output Current: Fanout of 15 LSTTL Loads (Q_A to Q_H outputs)
- Wide Operating Voltage: $V_{CC} = 2$ to 6 V
- Low Input Current: 1 μ A max
- Low Quiescent Supply Current: I_{CC} (static) = 4 μ A max ($T_a = 25^\circ\text{C}$)

Function Table

RCK	SCK	$\overline{\text{SCLR}}$	$\overline{\text{G}}$	Function
X	X	X	H	Q_A to Q_H high impedance
X	X	L	X	Shift register cleared $Q_H' = L$
X		H	X	Shift register clocked $Q_n = Q_{n-1}$, $Q_A = \text{SER}$
	X	H	X	Contents of shift register transferred to output latches

HD74HC595

Pin Arrangement

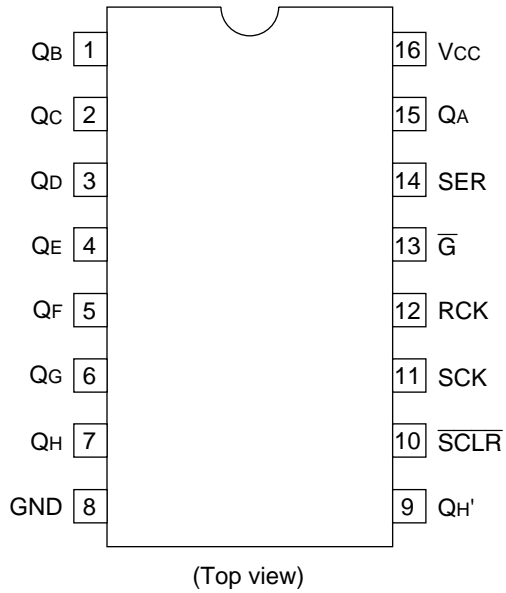

Absolute Maximum Ratings

Item	Symbol	Rating	Unit
Supply voltage range	V_{CC}	-0.5 to +7.0	V
Input voltage	V_{IN}	-0.5 to $V_{CC} + 0.5$	V
Output voltage	V_{OUT}	-0.5 to $V_{CC} + 0.5$	V
Output current	I_{OUT}	± 35	mA
DC current drain per V_{CC} , GND	I_{CC} , I_{GND}	± 75	mA
DC input diode current	I_{IK}	± 20	mA
DC output diode current	I_{OK}	± 20	mA
Power dissipation per package	P_T	500	mW
Storage Temperature	T_{stg}	-65 to +150	$^{\circ}C$

Logic Diagram

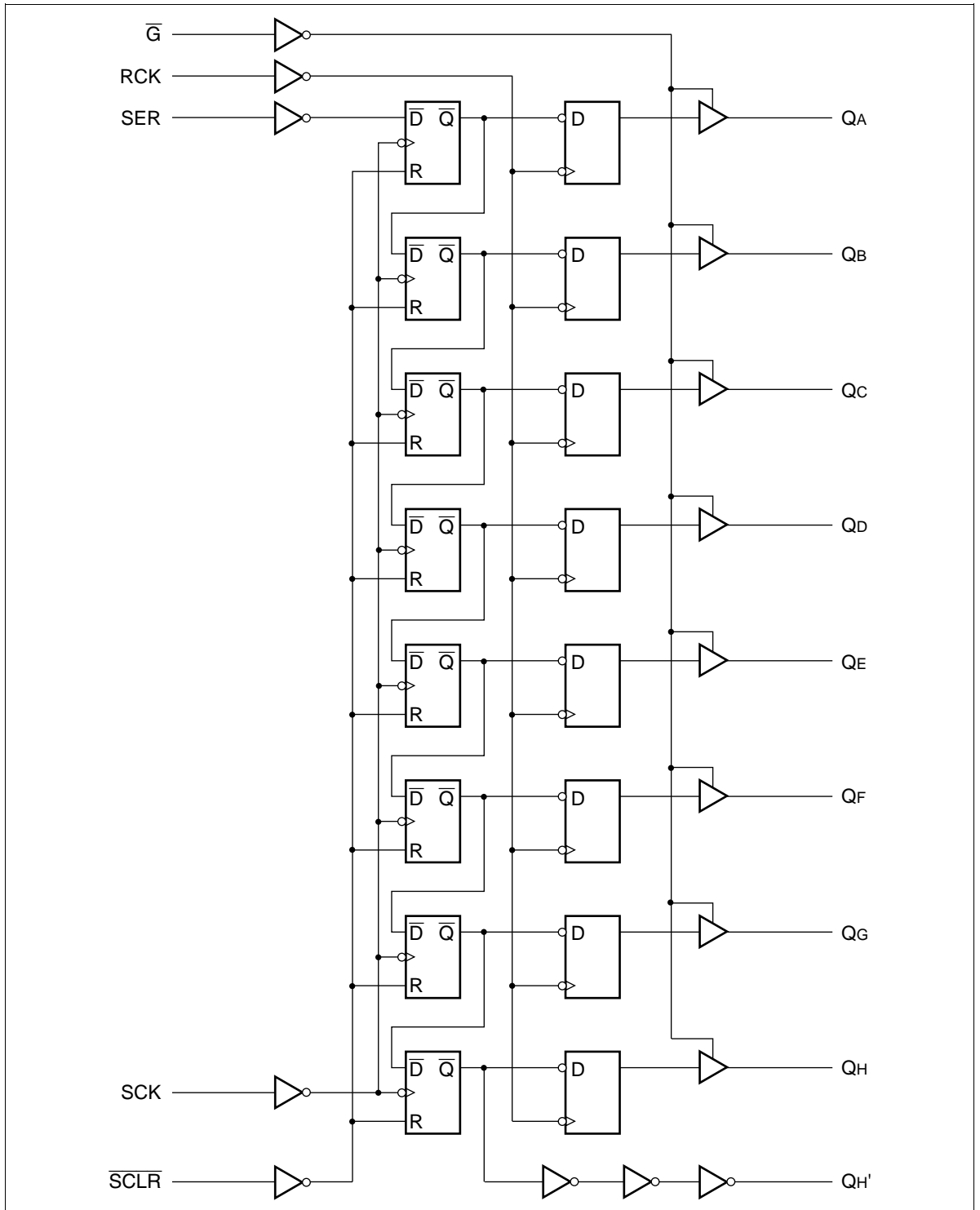

HITACHI

HD74HC595

DC Characteristics

Item	Symbol	V _{CC} (V)	Ta = 25°C		Ta = -40 to +85°C		Unit	Test Conditions			
			Min	Typ	Max	Min			Max		
Input voltage	V _{IH}	2.0	1.5	—	—	1.5	—	V			
		4.5	3.15	—	—	3.15	—				
		6.0	4.2	—	—	4.2	—				
	V _{IL}	2.0	—	—	0.5	—	0.5		V		
		4.5	—	—	1.35	—	1.35				
		6.0	—	—	1.8	—	1.8				
Output voltage	V _{OH}	2.0	1.9	2.0	—	1.9	—	V		Q _A to Q _H V _{in} = V _{IH} or V _{IL}	I _{OH} = -20 μA
		4.5	4.4	4.5	—	4.4	—				
		6.0	5.9	6.0	—	5.9	—				
		4.5	4.18	—	—	4.13	—		I _{OH} = -6 mA		
		6.0	5.68	—	—	5.63	—		I _{OH} = -7.8 mA		
		6.0	—	0.0	0.1	—	0.1		V		
	4.5	—	0.0	0.1	—	0.1					
	6.0	—	0.0	0.1	—	0.1					
	4.5	—	—	0.26	—	0.33	I _{OL} = 6 mA				
	6.0	—	—	0.26	—	0.33	I _{OL} = 7.8 mA				
	6.0	—	—	0.26	—	0.33	I _{OL} = 7.8 mA				
	Output voltage	V _{OH}	2.0	1.9	2.0	—	1.9	—	V	Q' _H V _{in} = V _{IH} or V _{IL}	I _{OH} = -20 μA
4.5			4.4	4.5	—	4.4	—				
6.0			5.9	6.0	—	5.9	—				
4.5			4.18	—	—	4.13	—	I _{OH} = -4 mA			
6.0			5.68	—	—	5.63	—	I _{OH} = -5.2 mA			
6.0			—	0.0	0.1	—	0.1	V			
4.5		—	0.0	0.1	—	0.1					
6.0		—	0.0	0.1	—	0.1					
4.5		—	—	0.26	—	0.33	I _{OL} = 4 mA				
6.0		—	—	0.26	—	0.33	I _{OL} = 5.2 mA				
6.0		—	—	0.26	—	0.33	I _{OL} = 5.2 mA				
Off-state output current		I _{OZ}	6.0	—	—	±0.5	—	±5.0	μA	V _{in} = V _{IH} or V _{IL} , V _{out} = V _{CC} or GND	
Input current	I _{in}	6.0	—	—	±0.1	—	±1.0	μA	V _{in} = V _{CC} or GND		
Quiescent supply current	I _{CC}	6.0	—	—	4.0	—	40	μA	V _{in} = V _{CC} or GND, I _{out} = 0 μA		

HITACHI

AC Characteristics ($C_L = 50$ pF, Input $t_r = t_f = 6$ ns)

Item	Symbol	V_{CC} (V)	$T_a = 25^\circ\text{C}$		$T_a = -40$ to $+85^\circ\text{C}$		Unit	Test Conditions	
			Min	Typ	Max	Min			Max
Maximum clock frequency	f_{max}	2.0	—	—	5	—	4	MHz	
		4.5	—	—	27	—	21		
		6.0	—	—	31	—	24		
Propagation delay time	t_{PLH}	2.0	—	—	115	—	145	ns	SCK to Q_H'
		4.5	—	12	23	—	29		
		6.0	—	—	20	—	25		
	t_{PHL}	2.0	—	—	150	—	190	ns	RCK to Q
		4.5	—	17	30	—	38		
		6.0	—	—	26	—	33		
t_{PLH}	2.0	—	—	175	—	220	ns	$\overline{\text{SCLR}}$ to Q_H'	
	4.5	—	20	35	—	44			
	6.0	—	—	30	—	37			
Output enable time	t_{ZL}	2.0	—	—	150	—	190	ns	
		4.5	—	13	30	—	38		
		6.0	—	—	26	—	33		
Output disable time	t_{ZH}	2.0	—	—	150	—	190	ns	
		4.5	—	15	30	—	38		
		6.0	—	—	26	—	33		
Setup time	t_{su}	2.0	100	—	—	125	—	ns	SER to SCK
		4.5	20	1	—	25	—		
		6.0	17	—	—	21	—		
	t_{su}	2.0	200	—	—	250	—	ns	SCK to RCK
		4.5	40	8	—	50	—		
		6.0	34	—	—	43	—		
Pulse width	t_w	2.0	80	—	—	100	—	ns	
		4.5	16	8	—	20	—		
		6.0	14	—	—	17	—		
Removal time	t_{rem}	2.0	100	—	—	125	—	ns	
		4.5	20	—	—	25	—		
		6.0	17	—	—	21	—		

HD74HC595

AC Characteristics ($C_L = 50$ pF, Input $t_r = t_f = 6$ ns) (cont)

Item	Symbol	V_{CC} (V)	Ta = 25°C		Ta = -40 to +85°C		Unit	Test Conditions	
			Min	Typ	Max	Min			Max
Hold time	t_h	2.0	5	—	—	5	—	ns	
		4.5	5	1	—	5	—		
		6.0	5	—	—	5	—		
Output rise/fall time	t_{TLH}	2.0	—	—	75	—	95	ns	Q_H'
	t_{THL}	4.5	—	5	15	—	19		
		6.0	—	—	13	—	16		
		2.0	—	—	60	—	75	ns	Q
	4.5	—	4	12	—	15			
	6.0	—	—	10	—	13			
Input capacitance	C_{in}	—	—	5	10	—	5	pF	

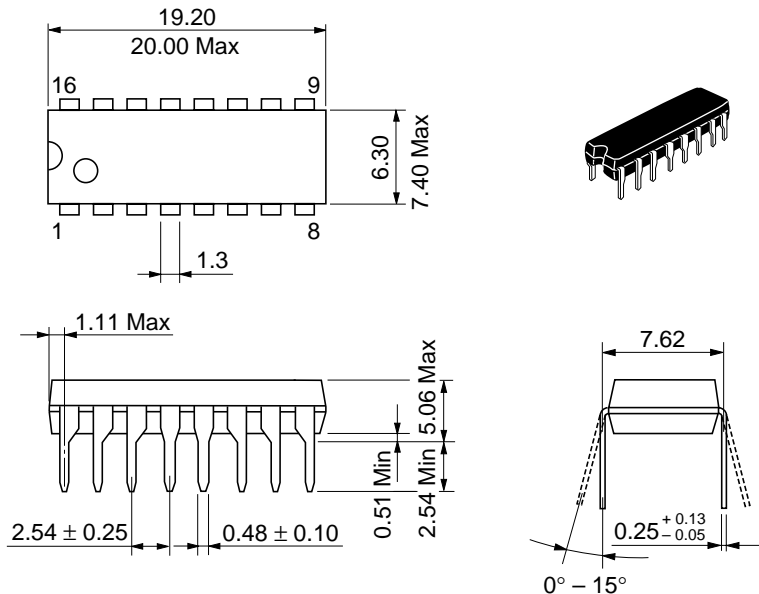

Hitachi Code	DP-16
JEDEC	Conforms
EIAJ	Conforms
Weight (reference value)	1.07 g

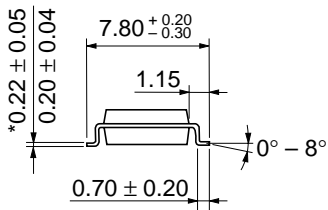
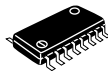
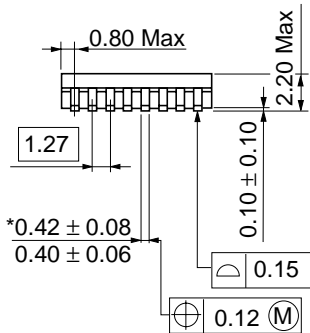
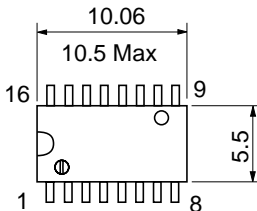

*Dimension including the plating thickness
Base material dimension

Hitachi Code	FP-16DA
JEDEC	—
EIAJ	Conforms
Weight (reference value)	0.24 g



*Dimension including the plating thickness
Base material dimension

Hitachi Code	FP-16DN
JEDEC	Conforms
EIAJ	Conforms
Weight (reference value)	0.15 g

Cautions

1. Hitachi neither warrants nor grants licenses of any rights of Hitachi's or any third party's patent, copyright, trademark, or other intellectual property rights for information contained in this document. Hitachi bears no responsibility for problems that may arise with third party's rights, including intellectual property rights, in connection with use of the information contained in this document.
2. Products and product specifications may be subject to change without notice. Confirm that you have received the latest product standards or specifications before final design, purchase or use.
3. Hitachi makes every attempt to ensure that its products are of high quality and reliability. However, contact Hitachi's sales office before using the product in an application that demands especially high quality and reliability or where its failure or malfunction may directly threaten human life or cause risk of bodily injury, such as aerospace, aeronautics, nuclear power, combustion control, transportation, traffic, safety equipment or medical equipment for life support.
4. Design your application so that the product is used within the ranges guaranteed by Hitachi particularly for maximum rating, operating supply voltage range, heat radiation characteristics, installation conditions and other characteristics. Hitachi bears no responsibility for failure or damage when used beyond the guaranteed ranges. Even within the guaranteed ranges, consider normally foreseeable failure rates or failure modes in semiconductor devices and employ systemic measures such as fail-safes, so that the equipment incorporating Hitachi product does not cause bodily injury, fire or other consequential damage due to operation of the Hitachi product.
5. This product is not designed to be radiation resistant.
6. No one is permitted to reproduce or duplicate, in any form, the whole or part of this document without written approval from Hitachi.
7. Contact Hitachi's sales office for any questions regarding this document or Hitachi semiconductor products.

HITACHI

Hitachi, Ltd.

Semiconductor & Integrated Circuits.
Nippon Bldg., 2-6-2, Ohte-machi, Chiyoda-ku, Tokyo 100-0004, Japan
Tel: Tokyo (03) 3270-2111 Fax: (03) 3270-5109

URL North America : <http://semiconductor.hitachi.com/>
 Europe : <http://www.hitachi-eu.com/hel/ecg>
 Asia (Singapore) : <http://www.has.hitachi.com.sg/grp3/sicd/index.htm>
 Asia (Taiwan) : http://www.hitachi.com.tw/E/Product/SICD_Frame.htm
 Asia (HongKong) : <http://www.hitachi.com.hk/eng/bo/grp3/index.htm>
 Japan : <http://www.hitachi.co.jp/Sicd/indx.htm>

For further information write to:

Hitachi Semiconductor
(America) Inc.
179 East Tasman Drive,
San Jose, CA 95134
Tel: <1> (408) 433-1990
Fax: <1> (408) 433-0223

Hitachi Europe GmbH
Electronic components Group
Dornacher Straße 3
D-85622 Feldkirchen, Munich
Germany
Tel: <49> (89) 9 9180-0
Fax: <49> (89) 9 29 30 00

Hitachi Europe Ltd.
Electronic Components Group.
Whitebrook Park
Lower Cookham Road
Maidenhead
Berkshire SL6 8YA, United Kingdom
Tel: <44> (1628) 585000
Fax: <44> (1628) 778322

Hitachi Asia Pte. Ltd.
16 Collyer Quay #20-00
Hitachi Tower
Singapore 049318
Tel: 535-2100
Fax: 535-1533

Hitachi Asia Ltd.
Taipei Branch Office
3F, Hung Kuo Building, No.167,
Tun-Hwa North Road, Taipei (105)
Tel: <886> (2) 2718-3666
Fax: <886> (2) 2718-8180

Hitachi Asia (Hong Kong) Ltd.
Group III (Electronic Components)
7/F., North Tower, World Finance Centre,
Harbour City, Canton Road, Tsim Sha Tsui,
Kowloon, Hong Kong
Tel: <852> (2) 735 9218
Fax: <852> (2) 730 0281
Telex: 40815 HITEC HX

Copyright ' Hitachi, Ltd., 1999. All rights reserved. Printed in Japan.

HITACHI