

HD63B09E, HD63C09E

CMOS MPU (Micro Processing Unit)

The HD6309E is the highest 8-bit microprocessor of HMCS6800 family, which is just compatible with the conventional HD6809E.

The HD6309E has hardware and software features which make it an ideal processor for higher level language execution or standard controller applications. External clock inputs are provided to allow synchronization with peripherals, systems or other MPUs.

The HD6309E is complete CMOS device and the power dissipation is extremely low. Moreover, the SYNC and CWAI instruction makes low power application possible.

■ FEATURES

- Hardware — Interface with All HMCS6800 Peripherals
- Software — Object Code Compatible with the HD6809E
- Low Power Consumption Mode (Sleep mode)
 - SYNC state of SYNC Instruction
 - WAIT state of CWAI Instruction
- External Clock Inputs, E and Q, Allow Synchronization
- Wide Operation Range
 - $f = 0.5$ to 3MHz ($V_{CC}=5V \pm 10\%$)

Type No.	Bus Timing
HD63B09E	2.0MHz
HD63C09E	3.0MHz

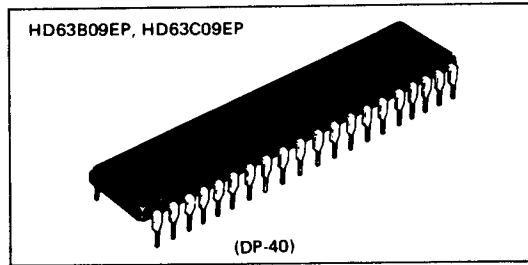

■ PIN ARRANGEMENT

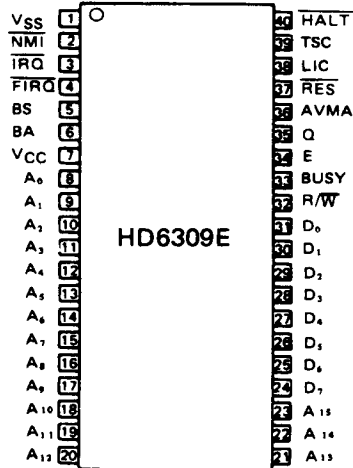

(Top View)



Hitachi America, Ltd. • Hitachi Plaza • 2000 Sierra Point Pkwy. • Brisbane, CA 94005-1819 • (415) 589-8300

277

■ ABSOLUTE MAXIMUM RATINGS

Item	Symbol	Value	Unit
Supply Voltage	V_{CC}^*	-0.3 ~ +7.0	V
Input Voltage	V_{in}^*	-0.3 ~ +7.0	V
Maximum Output Current	$ I_{O1} ^{**}$	5	mA
Maximum Total Output Current	$ \sum I_{O} ^{***}$	100	mA
Operating Temperature	T_{opr}	-20 ~ +75	°C
Storage Temperature	T_{stg}	-55 ~ +150	°C

- * With respect to V_{SS} (SYSTEM GND)
 - ** Maximum output current is the maximum currents which can flow out from one output terminal and I/O common terminal. ($A_0 \sim A_{15}$, R/W, $D_0 \sim D_7$, BA, BS, LIC, AVMA, BUSY)
 - *** Maximum total output current is the total sum of output currents which can flow out simultaneously from output terminals and I/O common terminals. ($A_0 \sim A_{15}$, R/W, $D_0 \sim D_7$, BA, BS, LIC, AVMA, BUSY)
- (NOTE) Permanent LSI damage may occur if maximum ratings are exceeded. Normal operation should be under recommended operating conditions. If these conditions are exceeded, it could affect reliability of LSI.

■ RECOMMENDED OPERATING CONDITIONS

Item	Symbol	min	typ	max	Unit	
Supply Voltage	V_{CC}^*	4.5	5.0	5.5	V	
Input Voltage	Logic, RES	V_{IL}^*	-0.3	-	0.8	V
	E, Q	V_{ILC}^*	-0.3	-	0.4	V
	Logic	V_{IH}^*	2.0	-	V_{CC}	V
	E, Q		3.0	-	V_{CC}	V
	RES		$V_{CC}-0.5$	-	V_{CC}	V
Operating Temperature	T_{opr}	-20	25	75	°C	

* With respect to V_{SS} (SYSTEM GND)

■ ELECTRICAL CHARACTERISTICS

● DC CHARACTERISTICS ($V_{CC}=5.0V \pm 10\%$, $V_{SS}=0V$, $T_a=-20 \sim +75^\circ C$, unless otherwise noted.)

Item	Symbol	Test Condition	HD63B09E			HD63C09E			Unit	
			min	typ*	max	min	typ*	max		
Input "High" Voltage	Logic	V_{IH}	2.0	-	V_{CC}	2.0	-	V_{CC}	V	
	E, Q	V_{IH}	3.0	-	V_{CC}	3.0	-	V_{CC}	V	
	RES	V_{IHR}	$V_{CC}-0.5$	-	V_{CC}	$V_{CC}-0.5$	-	V_{CC}	V	
Input "Low" Voltage	Logic, RES	V_{IL}	-0.3	-	0.8	-0.3	-	0.8	V	
	E, Q	V_{ILC}	-0.3	-	0.4	-0.3	-	0.4	V	
Input Leakage Current	Logic, Q, RES	I_{in}	$V_{in}=0 \sim V_{CC}, V_{CC}=\max$	-2.5	-	2.5	-2.5	-	2.5	μA
	E		-10	-	10	-10	-	10	μA	
Output "High" Voltage	$D_0 \sim D_7$	VOH	$I_{LOAD}=-400\mu A$	4.1	-	-	4.1	-	-	V
			$I_{LOAD} \leq -10\mu A$	$V_{CC}-0.1$	-	-	$V_{CC}-0.1$	-	-	V
	$I_{LOAD}=-400\mu A$		4.1	-	-	4.1	-	-	V	
	$I_{LOAD} \leq -10\mu A$		$V_{CC}-0.1$	-	-	$V_{CC}-0.1$	-	-	V	
	BA, BS, LIC, AVMA, BUSY		$I_{LOAD}=-400\mu A$	4.1	-	-	4.1	-	-	V
$I_{LOAD} \leq -10\mu A$	$V_{CC}-0.1$	-	-	$V_{CC}-0.1$	-	-	V			
Output "Low" Voltage	VOL	$I_{LOAD}=2mA$	-	-	0.5	-	-	0.5	V	
Input Capacitance	C_{in}	$V_{in}=0V, T_a=25^\circ C, f=1MHz$	$D_0 \sim D_7$, Logic	-	10	15	-	10	15	pF
			Input Q, RES	-	30	50	-	30	50	pF
Output Capacitance	C_{out}	$V_{in}=0V, T_a=25^\circ C, f=1MHz$	-	10	15	-	10	15	pF	
Frequency of Operation	E, Q	f	0.5	-	2.0	0.5	-	3.0	MHz	
Three-State (Off State) Input Current	I_{TSI}	$V_{in}=0.4 \sim V_{CC}, V_{CC}=\max$	$D_0 \sim D_7$	-10	-	10	-10	-	10	μA
$A_0 \sim A_{15}$, R/W			-10	-	10	-10	-	10	μA	
Current Dissipation	I_{CC}	Operating	-	-	20	-	-	30	mA	
		Sleeping	-	-	10	-	-	15	mA	

* $T_a=25^\circ C, V_{CC}=5V$



● AC CHARACTERISTICS (V_{CC}=5.0V±10%, V_{SS}=0, T_a=-20 ~ +75°C, unless otherwise noted.)

1. CLOCK TIMING

Item	Symbol	Test Condition	HD63B09E			HD63C09E			Unit	
			min	typ	max	min	typ	max		
Cycle Time	t _{cyc}	Fig. 1,2	500	—	2000	333	—	2000	ns	
E Clock "Low"	t _{PWEL}		210	—	1000	140	—	1000	ns	
E Clock "High" (Measured at V _{IH})	t _{PWEH}		220	—	1000	140	—	1000	ns	
E Rise and Fall Time	t _{Er} , t _{Ef}		—	—	20	—	—	15	ns	
Q Clock "High"	t _{PWQH}		220	—	1000	140	—	1000	ns	
Q Rise and Fall Time	t _{Qr} , t _{Qf}		—	—	20	—	—	15	ns	
E "Low" to Q Rising	E "Low"→Q"High"		t _{EQ1}	100	—	—	65	—	—	ns
Q "High" to E Rising	Q "High"→E "High"		t _{EQ2}	100	—	—	65	—	—	ns
E "High" to Q Falling	E "High"→Q"Low"		t _{EQ3}	100	—	—	65	—	—	ns
Q "Low" to E Falling	Q "Low"→E "Low"		t _{EQ4}	100	—	—	65	—	—	ns

2. BUS TIMING

Item	Symbol	Test Condition	HD63B09E			HD63C09E			Unit	
			min	typ	max	min	typ	max		
Address Delay	t _{AD}	Fig. 1, 2	—	—	110	—	—	110	ns	
Address Hold Time (Address, R/W, BA, BS)	t _{AH}		T _a = 0 ~ 75°C	20	—	—	20	—	—	ns
			T _a = -20~0°C	10	—	—	10	—	—	
Peripheral Read Access Times (t _{cyc} -t _{Ef} -t _{AD} -t _{DSR} =t _{ACC})	t _{ACC}		330	—	—	185	—	—	ns	
Data Setup Time (Read)	t _{DSR}		40	—	—	20	—	—	ns	
Input Data Hold Time	t _{DHR}		20	—	—	20	—	—	ns	
Data Delay Time (Write)	t _{DDW}		—	—	110	—	—	70	ns	
Output Data Hold Time	t _{DHW}		T _a = 0~75°C	30	—	—	30	—	—	ns
			T _a = -20~0°C	20	—	—	20	—	—	

2

3. PROCESSOR CONTROL TIMING

Item	Symbol	Test Condition	HD63B09E			HD63C09E			Unit
			min	typ	max	min	typ	max	
Control Delay (BUSY, LIC, AVMA)	t _{CD}	Fig. 1, 2, 7 ~ 10, 14 and 17	—	—	200	—	—	130	ns
Interrupts Set Up Time	t _{PCS}		110	—	—	70	—	—	ns
HALT Set Up Time	t _{PCS}		110	—	—	70	—	—	ns
RES Set Up Time	t _{PCS}		110	—	—	70	—	—	ns
TSC Setup Time	t _{PCS}		110	—	—	70	—	—	ns
TSC Drive to Valid Logic Levels	t _{TSA}		—	—	120	—	—	120	ns
TSC Release MOS Buffers to High Impedance	t _{TSR}		—	—	110	—	—	110	ns
TSC Three-State Delay	t _{TSD}		—	—	80	—	—	80	ns
Processor Control Rise/Fall	t _{PCr} , t _{PCf}		—	—	100	—	—	100	ns
TSC Input Delay	t _{PCT}		30	—	—	30	—	—	ns



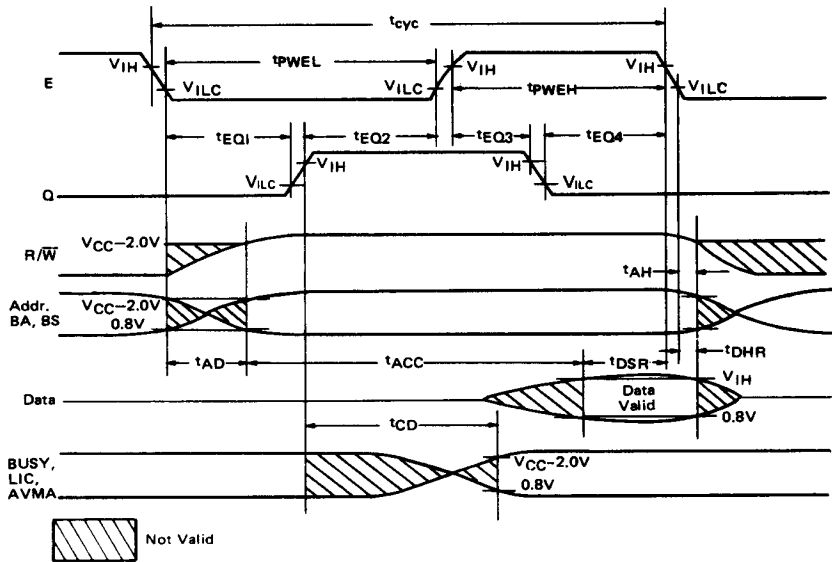

(NOTE) Waveform measurements for all inputs and outputs are specified at logic "High" = V_{IHmin} and logic "Low" = V_{ILmax} unless otherwise specified.

Figure 1 Read Data from Memory or Peripherals

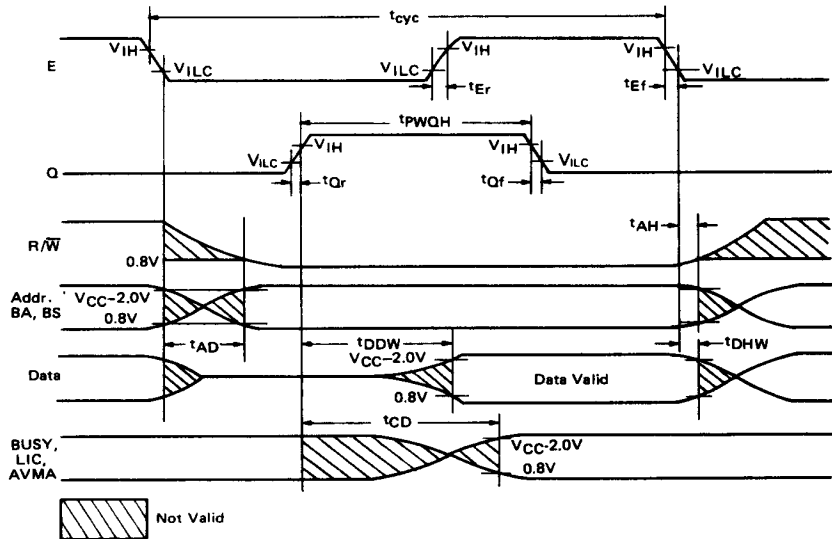

(NOTE) Waveform measurements for all inputs and outputs are specified at logic "High" = V_{IHmin} and logic "Low" = V_{ILmax} unless otherwise specified.

Figure 2 Write Data to Memory or Peripherals



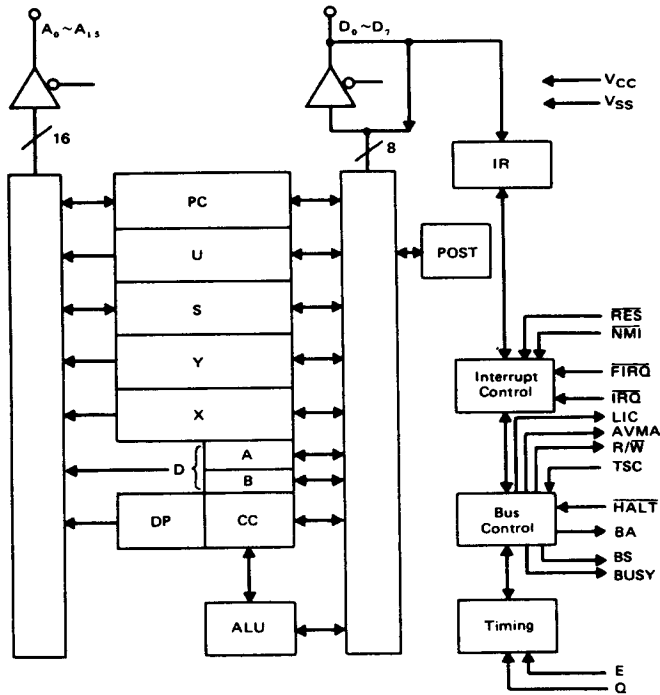
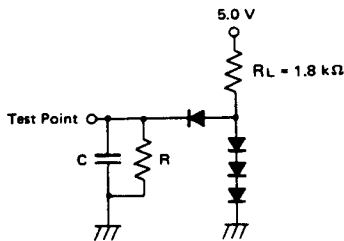

Figure 3 HD6309E Expanded Block Diagram



C = 30 pF for BA, BS, LIC, AVMA, BUSY
 130 pF for D₀ ~ D₇
 90 pF for A₀ ~ A₁₅, R/W

R = 10 kΩ for D₀ ~ D₇
 10 kΩ for A₀ ~ A₁₅, R/W
 10 kΩ for BA, BS, LIC, AVMA, BUSY

All diodes are 1S2074(H) or equivalent.
 C includes stray capacitance.

Figure 4 Bus Timing Test Load

■ PROGRAMMING MODEL

As shown in Figure 5, the HD6309E adds three registers to the set available in the HD6800. The added registers include a Direct Page Register, the User Stack pointer and a second Index Register.

● Accumulators (A, B, D)

The A and B registers are general purpose accumulators which are used for arithmetic calculations and manipulation of data.

Certain instructions concatenate the A and B registers to form a single 16-bit accumulator. This is referred to as the D Register, and is formed with the A Register as the most significant byte.

● Direct Page Register (DP)

The Direct Page Register of the HD6309E serves to enhance the Direct Addressing Mode. The content of this register appears at the higher address outputs (A₈ ~ A₁₅) during direct addressing instruction execution. This allows the direct mode to be used at any place in memory, under program control. To ensure HD6800 compatibility, all bits of this register are cleared during Processor Reset.



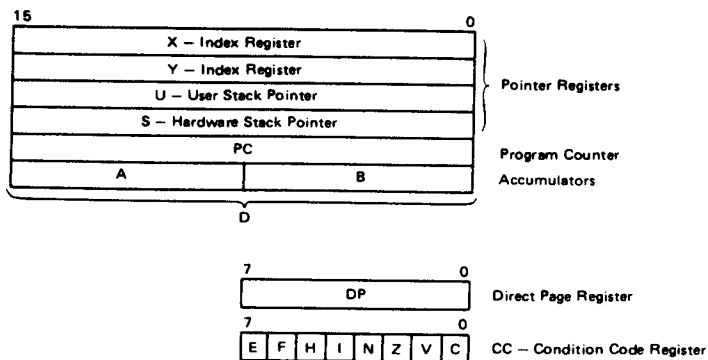

Figure 5 Programming Model of The Microprocessing Unit

● **Index Registers (X, Y)**

The Index Registers are used in indexed mode of addressing. The 16-bit address in this register takes part in the calculation of effective addresses. This address may be used to point to data directly or may be modified by an optional constant or register offset. During some indexed modes, the contents of the index register are incremented or decremented to point to the next item of tabular type data. All four pointer registers (X, Y, U, S) may be used as index registers.

● **Stack Pointer (U, S)**

The Hardware Stack Pointer (S) is used automatically by the processor during subroutine calls and interrupts. The User Stack Pointer (U) is controlled exclusively by the programmer thus allowing arguments to be passed to and from subroutines with ease. The U-register is frequently used as a stack marker. Both Stack Pointers have the same indexed mode addressing capabilities as the X and Y registers, but also support **Push** and **Pull** instructions. This allows the HD6309E to be used efficiently as a stack processor, greatly enhancing its ability to support higher level languages and modular programming.

(NOTE) The stack pointers of the HD6309E point to the top of the stack, in contrast to the HD6800 stack pointer, which pointed to the next free location on stack.

● **Program Counter (PC)**

The Program Counter is used by the processor to point to the address of the next instruction to be executed by the processor. Relative Addressing is provided allowing the Program Counter to be used like an index register in some situations.

● **Condition Code Register (CC)**

The Condition Code Register defines the state of the processor at any given time. See Figure 6.

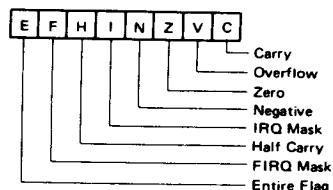

Figure 6 Condition Code Register Format

■ **CONDITION CODE REGISTER DESCRIPTION**

● **Bit 0 (C)**

Bit 0 is the carry flag, and is usually the carry from the binary ALU. C is also used to represent a 'borrow' from subtract like instructions (CMP, NEG, SUB, SBC) and is the complement of the carry from the binary ALU.

● **Bit 1 (V)**

Bit 1 is the overflow flag, and is set to a one by an operation which causes a signed two's complement arithmetic overflow. This overflow is detected in an operation in which the carry from the MSB in the ALU does not match the carry from the MSB-1.

● **Bit 2 (Z)**

Bit 2 is the zero flag, and is set to a one if the result of the previous operation was identically zero.

● **Bit 3 (N)**

Bit 3 is the negative flag, which contains exactly the value of the MSB of the result of the preceding operation. Thus, a negative two's-complement result will leave N set to a one.



● **Bit 4 (I)**

Bit 4 is the \overline{IRQ} mask bit. The processor will not recognize interrupts from the \overline{IRQ} line if this bit is set to a one. \overline{NMI} , \overline{FIRQ} , \overline{IRQ} , \overline{RES} and \overline{SWI} all set I to a one; $\overline{SWI2}$ and $\overline{SWI3}$ do not affect I.

● **Bit 5 (H)**

Bit 5 is the half-carry bit, and is used to indicate a carry from bit 3 in the ALU as a result of an 8-bit addition only (ADC or ADD). This bit is used by the DAA instruction to perform a BCD decimal add adjust operation. The state of this flag is undefined in all subtract-like instructions.

● **Bit 6 (F)**

Bit 6 is the \overline{FIRQ} mask bit. The processor will not recognize interrupts from the \overline{FIRQ} line if this bit is a one. \overline{NMI} , \overline{FIRQ} , \overline{SWI} , and \overline{RES} all set F to a one. \overline{IRQ} , $\overline{SWI2}$ and $\overline{SWI3}$ do not affect F.

● **Bit 7 (E)**

Bit 7 is the entire flag, and when set to a one indicates that the complete machine state (all the registers) was stacked, as opposed to the subset state (PC and CC). The E bit of the stacked CC is used on a return from interrupt (RTI) to determine the extent of the unstacking. Therefore, the current E left in the Condition Code Register represents past action.

■ **HD6309E MPU SIGNAL DESCRIPTION**

● **Power (VSS, VCC)**

Two pins are used to supply power to the part: VSS is ground or 0 volts, while VCC is +5.0 V \pm 10%.

● **Address Bus (A₀ ~ A₁₅)**

Sixteen pins are used to output address information from the MPU onto the Address Bus. When the processor does not require the bus for a data transfer, it will output address FFFF₁₆, R/W = "High", and BS = "Low"; this is a "dummy access" or \overline{VMA} cycle. All address bus drivers are made high-impedance when output Bus Available (BA) is "High" or when TSC is asserted. Each pin will drive one Schottky TTL load or four LS TTL loads, and 90 pF. Refer to Figures 1 and 2.

● **Data Bus (D₀ ~ D₇)**

These eight pins provide communication with the system bi-directional data bus. Each pin will drive one Schottky TTL load or four LS TTL loads, and 130 pF.

● **Read/Write (R/W)**

This signal indicates the direction of data transfer on the data bus. A "Low" indicates that the MPU is writing data onto the data bus. R/W is made high impedance when BA is "High" or when TSC is asserted. Refer to Figures 1 and 2.

● **RES**

A "Low" level on this Schmitt-trigger input for greater than one bus cycle will reset the MPU, as shown in Figure 7. The Reset vectors are fetched from locations FFFE₁₆ and FFFF₁₆ (Table 1) when Interrupt Acknowledge is true, ($\overline{BA} \cdot BS = 1$). During initial power-on, the Reset line should be held "Low" until the clock input signals are fully operational.

Because the HD6309E Reset pin has a Schmitt-trigger input with a threshold voltage higher than that of standard peripherals, a simple R/C network may be used to reset the entire system.

This higher threshold voltage ensures that all peripherals are out of the reset state before the Processor.

Table 1 Memory Map for Interrupt Vectors

Memory Map for Vector Locations		Interrupt Vector Description
MS	LS	
FFFE	FFFF	RES
FFFC	FFFD	NMI
FFFA	FFFB	SWI
FFF8	FFF9	\overline{IRQ}
FFF6	FFF7	\overline{FIRQ}
FFF4	FFF5	SWI2
FFF2	FFF3	SWI3
FFF0	FFF1	Reserved

● **HALT**

A "Low" level on this input pin will cause the MPU to stop running at the end of the present instruction and remain halted indefinitely without loss of data. When halted, the BA output is driven "High" indicating the buses are high impedance. BS is also "High" which indicates the processor is in the Halt state. While halted, the MPU will not respond to external real-time requests (\overline{FIRQ} , \overline{IRQ}) although \overline{NMI} or \overline{RES} will be latched for later response. During the Halt state Q and E should continue to run normally. A halted state ($\overline{BA} \cdot BS = 1$) can be achieved by pulling HALT "Low" while RES is still "Low". See Figure 8.

● **Bus Available, Bus Status (BA, BS)**

The Bus Available output is an indication of an internal control signal which makes the MOS buses of the MPU high impedance. When BA goes "Low", a dead cycle will elapse before the MPU acquires the bus. BA will not be asserted when TSC is active, thus allowing dead cycle consistency.

The Bus Status output signal, when decoded with BA, represents the MPU state (valid with leading edge of Q).

MPU State		MPU State Definition
BA	BS	
0	0	Normal (Running)
0	1	Interrupt or RESET Acknowledge
1	0	SYNC Acknowledge
1	1	HALT Acknowledge

Interrupt Acknowledge is indicated during both cycles of a hardware-vector-fetch (RES, NMI, \overline{FIRQ} , \overline{IRQ} , SWI, SWI2, SWI3). This signal, plus decoding of the lower four address lines, can provide the user with an indication of which interrupt level is being serviced and allow vectoring by device. See Table 1.

Sync Acknowledge is indicated while the MPU is waiting for external synchronization on an interrupt line.

Halt Acknowledge is indicated when the HD6309E is in a Halt condition.



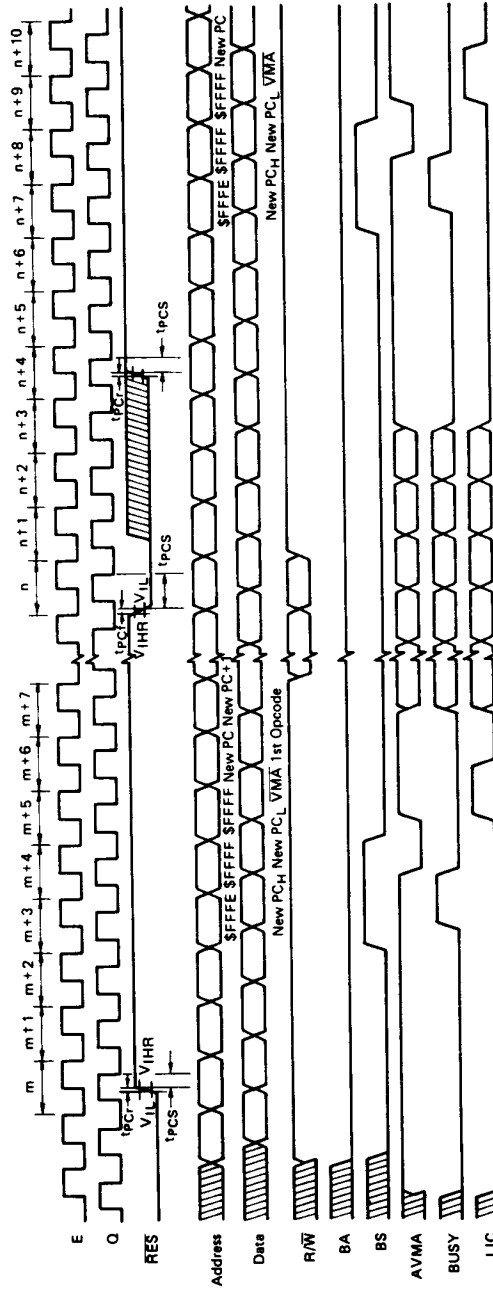

(NOTE) Waveform measurements for all inputs and outputs are specified at logic "High" = V_{IHmin} and logic "Low" = V_{ILmax} unless otherwise specified.

Figure 7 RES Timing



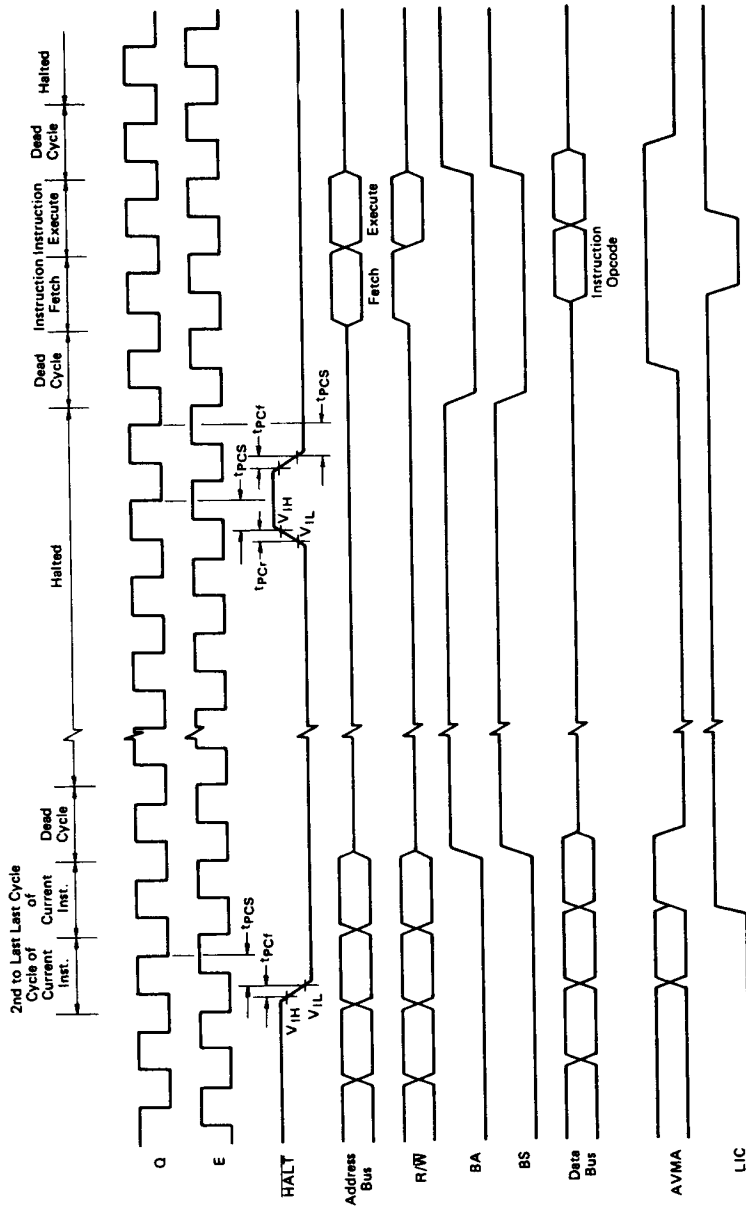

(NOTE) Waveform measurements for all inputs and outputs are specified at logic "High" = V_{IHmin} and logic "Low" = V_{LLmax} , unless otherwise specified.

Figure 8 HALT and Single Instruction Execution for System Debug



• **Non Maskable Interrupt ($\overline{\text{NMI}}$)***

A negative transition on this input requests that a non-maskable interrupt sequence be generated. A non-maskable interrupt cannot be inhibited by the program, and also has a higher priority than $\overline{\text{FIRQ}}$, $\overline{\text{IRQ}}$ or software interrupts. During recognition of an $\overline{\text{NMI}}$, the entire machine state is saved on the hardware stack. After reset, an $\overline{\text{NMI}}$ will not be recognized until the first program load of the Hardware Stack Pointer (S). The pulse width of $\overline{\text{NMI}}$ low must be at least one E cycle. If the $\overline{\text{NMI}}$ input does not meet the minimum set up with respect to Q, the interrupt will not be recognized until the next cycle. See Figure 9.

• **Fast-Interrupt Request ($\overline{\text{FIRQ}}$)***

A "Low" level on this input pin will initiate a fast interrupt sequence, provided its mask bit (F) in the CC is clear. This sequence has priority over the standard Interrupt Request ($\overline{\text{IRQ}}$), and is fast in the sense that it stacks only the contents of the condition code register and the program counter. The interrupt service routine should clear the source of the interrupt before doing an RTI. See Figure 10.

• **Interrupt Request ($\overline{\text{IRQ}}$)***

A "Low" level input on this pin will initiate an Interrupt Request sequence provided the mask bit (I) in the CC is clear. Since $\overline{\text{IRQ}}$ stacks the entire machine state it provides a slower response to interrupts than $\overline{\text{FIRQ}}$. $\overline{\text{IRQ}}$ also has a lower priority than $\overline{\text{FIRQ}}$. Again, the interrupt service routine should clear the source of the interrupt before doing an RTI. See Figure 9.

* $\overline{\text{NMI}}$, $\overline{\text{FIRQ}}$, and $\overline{\text{IRQ}}$ requests are sampled on the falling edge of Q. One cycle is required for synchronization before these interrupts are recognized. The pending interrupt(s) will not be serviced until completion of the current instruction unless a SYNC or CWA1 condition is present. If $\overline{\text{IRQ}}$ and $\overline{\text{FIRQ}}$ do not remain "Low" until completion of the current instruction they may not be recognized. However, $\overline{\text{NMI}}$ is latched and need only remain "Low" for one cycle.

• **Clock Inputs E, Q**

E and Q are the clock signals required by the HD6309E. Q must lead E; that is, a transition on Q must be followed by a similar transition on E after a minimum delay. Addresses will be valid from the MPU, t_{AD} after the falling edge of E, and data will be latched from the bus by the falling edge of E. While the Q input is fully TTL compatible, the E input directly drives internal MOS circuitry and, thus, requires levels above normal TTL levels. This approach minimizes clock skew inherent with an internal buffer. Timing and waveforms for E and Q are shown in Figures 1 and 2 while Figure 11 shows a simple clock generator for the HD6309E.

• **BUSY**

Busy will be "High" for the read and modify cycles of a read-modify-write instruction and during the access of the first byte

of a double-byte operation (e.g., LDX, STD, ADD). Busy is also "High" during the first byte of any indirect or other vector fetch (e.g., jump extended, SWI indirect etc.).

In a multi-processor system, busy indicates the need to defer the re-arbitration of the next bus cycle to insure the integrity of the above operations. This difference provides the indivisible memory access required for a "test-and-set" primitive, using any one of several read-modify-write instructions.

Busy does not become active during PSH or PUL operations. A typical read-modify-write instruction (ASL) is shown in Figure 12. Timing information is given in Figure 13. Busy is valid t_{CD} after the rising edge of Q.

• **AVMA**

AVMA is the Advanced VMA signal and indicates that the MPU will use the bus in the following bus cycle. The predictive nature of the AVMA signal allows efficient shared-bus multi-processor systems. AVMA is "Low" when the MPU is in either a HALT or SYNC state. AVMA is valid t_{CD} after the rising edge of Q.

• **LIC**

LIC (Last Instruction Cycle) is "High" during the last cycle of every instruction, and its transition from "High" to "Low" will indicate that the first byte of an opcode will be latched at the end of the present bus cycle. LIC will be "High" when the MPU is Halted at the end of an instruction, (i.e., not in CWA1 or RESET) in SYNC state or while stacking during interrupts. LIC is valid t_{CD} after the rising edge of Q.

• **TSC**

TSC (Three-State Control) will cause MOS address, data, and R/W buffers to assume a high-impedance state. The control signals (BA, BS, BUSY, AVMA and LIC) will not go to the high-impedance state. TSC is intended to allow a single bus to be shared with other bus masters (processors or DMA controllers).

While E is "Low", TSC controls the address buffers and R/W directly. The data bus buffers during a write operation are in a high-impedance state until Q rises at which time, if TSC is true, they will remain in a high-impedance state. If TSC is held beyond the rising edge of E, then it will be internally latched, keeping the bus drivers in a high-impedance state for the remainder of the bus cycle. See Figure 14.

• **MPU Operation**

During normal operation, the MPU fetches an instruction from memory and then executes the requested function. This sequence begins after $\overline{\text{RES}}$ and is repeated indefinitely unless altered by a special instruction or hardware occurrence. Software instructions that alter normal MPU operation are: SWI, SWI2, SWI3, CWA1, RTI and SYNC. An interrupt or HALT input can also alter the normal execution of instructions. Figure 15 illustrates the flow chart for the HD6309E.



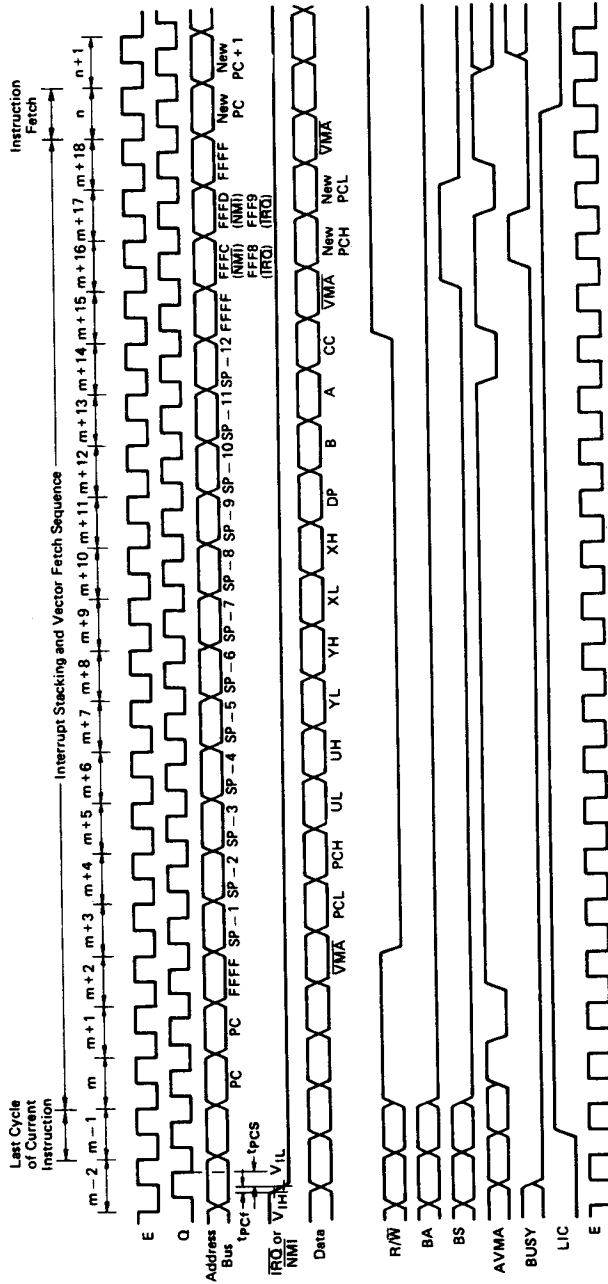

(NOTE) Waveform measurements for all inputs and outputs are specified at logic "High" = V_{IHmin} and logic "Low" = V_{ILmax} unless otherwise specified.
 E clock shown for reference only.

Figure 9 $\overline{\text{IRQ}}$ and $\overline{\text{NMI}}$ Interrupt Timing



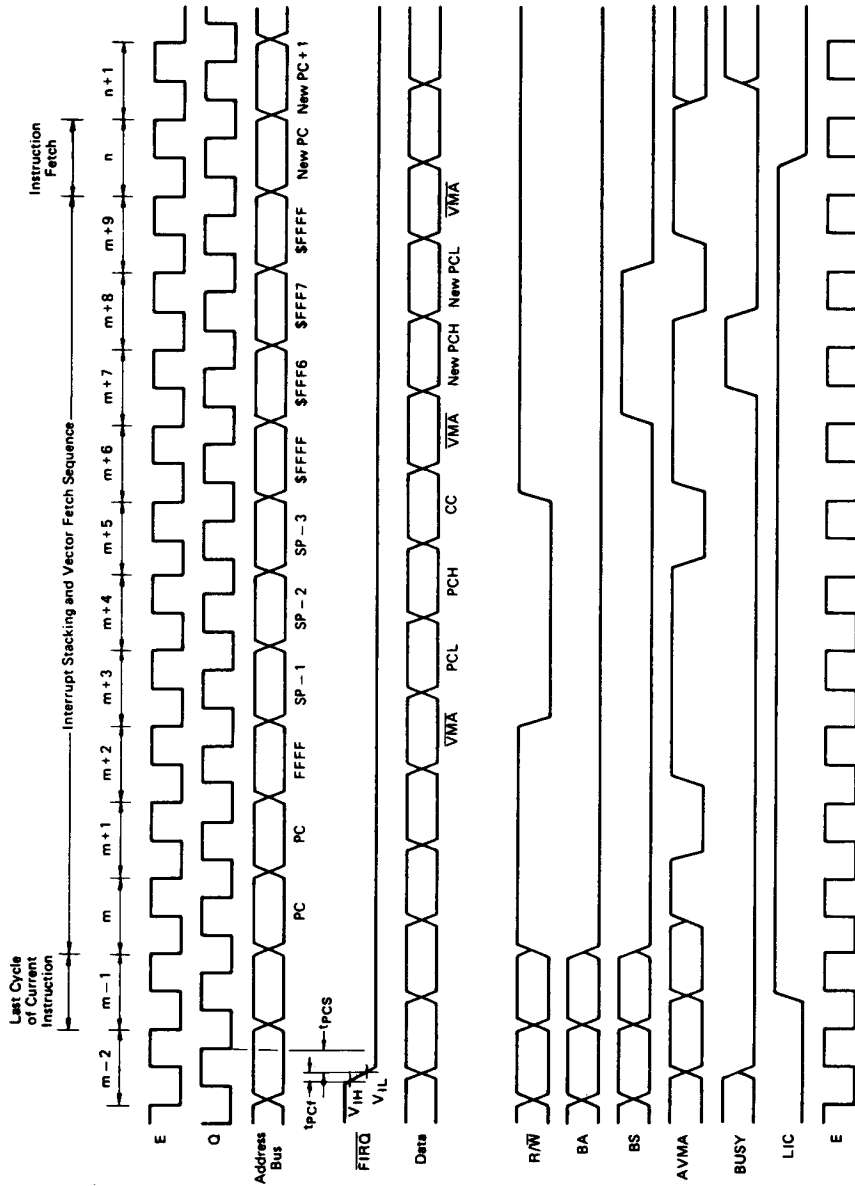

(NOTE) Waveform measurements for all inputs and outputs are specified at logic "High" = V_{IHmin} and logic "Low" = V_{Lmax} , unless otherwise specified. E clock shown for reference only.

Figure 10 FIRQ Interrupt Timing



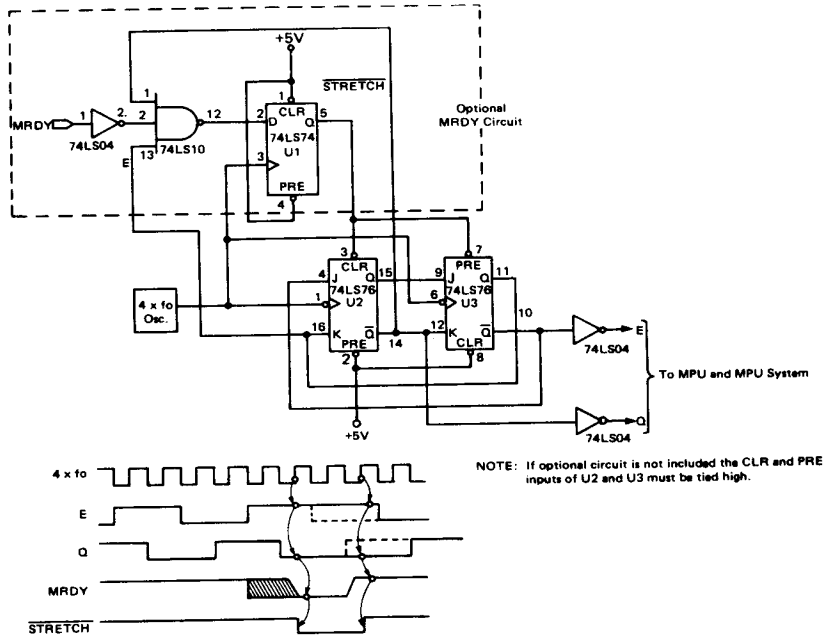

Figure 11 HD6309E Clock Generator

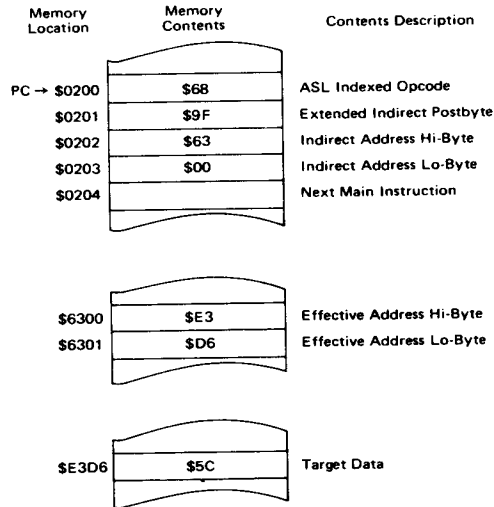

Figure 12 Read Modify Write Instruction Example (ASL Extended Indirect)



■ ADDRESSING MODES

The basic instructions of any computer are greatly enhanced by the presence of powerful addressing modes. The HD6309E has the most complete set of addressing modes available on any microcomputer today. For example, the HD6309E has 59 basic instructions; however, it recognizes 1464 different variations of instructions and addressing modes. The addressing modes support modern programming techniques. The following addressing modes are available on the HD6309E:

- (1) Implied (Includes Accumulator)
- (2) Immediate
- (3) Extended
- (4) Extended Indirect
- (5) Direct
- (6) Register
- (7) Indexed
 - Zero-Offset
 - Constant Offset
 - Accumulator Offset
 - Auto Increment/Decrement
- (8) Indexed Indirect
- (9) Relative
- (10) Program Counter Relative

● Implied (Includes Accumulator)

In this addressing mode, the opcode of the instruction contains all the address information necessary. Examples of Implied Addressing are: ABX, DAA, SWI, ASRA, and CLR.B.

● Immediate Addressing

In Immediate Addressing, the effective address of the data is the location immediately following the opcode (i.e., the data to be used in the instruction immediately follows the opcode of the instruction). The HD6309E uses both 8 and 16-bit immediate values depending on the size of argument specified by the opcode. Examples of instructions with Immediate Addressing are:

```
LDA #520
LDX #$F000
LDY #CAT
```

(NOTE) # signifies immediate addressing, \$ signifies hexadecimal value.

● Extended Addressing

In Extended Addressing, the contents of the two bytes immediately following the opcode fully specify the 16-bit effective address used by the instruction. Note that the address generated by an extended instruction defines an absolute address and is not position independent. Examples of Extended Addressing include:

```
LDA CAT
STX MOUSE
LDD $2000
```

● Extended Indirect

As a special case of indexed addressing (discussed below), one level of indirection may be added to Extended Addressing. In Extended Indirect, the two bytes following the postbyte of an Indexed instruction contain the address of the data.

```
LDA [CAT]
LDX [$FFFE]
STU [DOG]
```

● Direct Addressing

Direct addressing is similar to extended addressing except that only one byte of address follows the opcode. This byte specifies the lower 8 bits of the address to be used. The upper 8 bits of the address are supplied by the direct page register. Since only one byte of address is required in direct addressing, this mode requires less memory and executes faster than extended addressing. Of course, only 256 locations (one page) can be accessed without redefining the contents of the DP register. Since the DP register is set to \$00 on Reset, direct addressing on the HD6309E is compatible with direct addressing on the HD6800. Indirection is not allowed in direct addressing. Some examples of direct addressing are:

```
LDA $30
SETDP $10 (Assembler directive)
LDB $1030
LDD <CAT
```

(NOTE) < is an assembler directive which forces direct addressing.

● Register Addressing

Some opcodes are followed by a byte that defines a register or set of registers to be used by the instruction. This is called a postbyte. Some examples of register addressing are:

```
TFR X, Y Transfer X into Y
EXG A, B Exchanges A with B
PSHS A, B, X, Y Push Y, X, B and A onto S
PULU X, Y, D Pull D, X, and Y from U
```

● Indexed Addressing

In all indexed addressing, one of the pointer registers (X, Y, U, S, and sometimes PC) is used in a calculation of the effective address of the operand to be used by the instruction. Five basic types of indexing are available and are discussed below. The postbyte of an indexed instruction specifies the basic type and variation of the addressing mode as well as the pointer register to be used. Figure 16 lists the legal formats for the postbyte. Table 2 gives the assembler form and the number of cycles and bytes added to the basic values for indexed addressing for each variation.

Post-Byte Register Bit								Indexed Addressing Mode
7	6	5	4	3	2	1	0	
0	R	R	d	d	d	d	d	EA = R + 5 Bit Offset
1	R	R	0	0	0	0	0	,R +
1	R	R	1	0	0	0	1	,R ++
1	R	R	0	0	0	1	0	,-R
1	R	R	1	0	0	1	1	,-R
1	R	R	i	0	1	0	0	EA = R + 0 Offset
1	R	R	i	0	1	0	1	EA = R + ACCE Offset
1	R	R	i	0	1	1	0	EA = R + ACCA Offset
1	R	R	i	1	0	0	0	EA = R + 8 Bit Offset
1	R	R	i	1	0	0	1	EA = R + 16 Bit Offset
1	R	R	i	1	0	1	1	EA = R + D Offset
1	x	x	i	1	1	0	0	EA = PC + 8 Bit Offset
1	x	x	i	1	1	0	1	EA = PC + 16 Bit Offset
1	R	R	i	1	1	1	1	EA = [Address]

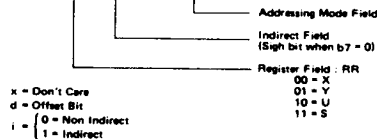

Figure 16 Index Addressing Postbyte Register Bit Assignments



Table 2 Indexed Addressing Mode

Type	Forms	Non Indirect			Indirect		
		Assembler Form	Postbyte OP Code	+ ~ #	Assembler Form	Postbyte OP Code	+ ~ #
Constant Offset From R (2's Complement Offsets)	No Offset	,R	1RR00100	0 0	[,R]	1RR10100	3 0
	5 Bit Offset	n, R	0RRnnnnn	1 0	defaults to 8-bit		
	8 Bit Offset	n, R	1RR01000	1 1	[n, R]	1RR11000	4 1
	16 Bit Offset	n, R	1RR01001	4 2	[n, R]	1RR11001	7 2
Accumulator Offset From R (2's Complement Offsets)	A Register Offset	A, R	1RR00110	1 0	[A, R]	1RR10110	4 0
	B Register Offset	B, R	1RR00101	1 0	[B, R]	1RR10101	4 0
	D Register Offset	D, R	1RR01011	4 0	[D, R]	1RR11011	7 0
Auto Increment/Decrement R	Increment By 1	,R +	1RR00000	2 0	not allowed		
	Increment By 2	,R ++	1RR00001	3 0	[,R ++]	1RR10001	6 0
	Decrement By 1	,- R	1RR00010	2 0	not allowed		
	Decrement By 2	,-- R	1RR00011	3 0	[,-- R]	1RR10011	6 0
Constant Offset From PC (2's Complement Offsets)	8 Bit Offset	n, PCR	1xx01100	1 1	[n, PCR]	1xx11100	4 1
	16 Bit Offset	n, PCR	1xx01101	5 2	[n, PCR]	1xx11101	8 2
Extended Indirect	16 Bit Address	-	-	-	[n]	10011111	5 2

R = X, Y, U or S RR:
 x = Don't Care 00 = X
 01 = Y
 10 = U
 11 = S

+ and # indicate the number of additional cycles and bytes for the particular variation.



Zero-Offset Indexed

In this mode, the selected pointer register contains the effective address of the data to be used by the instruction. This is the fastest indexing mode.

Examples are:
 LDD 0, X
 LDA S

Constant Offset Indexed

In this mode, a two's-complement offset and the contents of one of the pointer registers are added to form the effective address of the operand. The pointer register's initial content is unchanged by the addition.

Three sizes of offsets are available:
 5-bit (-16 to +15)
 8-bit (-128 to +127)
 16-bit (-32768 to +32767)

The two's complement 5-bit offset is included in the postbyte and, therefore, is most efficient in use of bytes and cycles. The two's complement 8-bit offset is contained in a single byte following the postbyte. The two's complement 16-bit offset is in the two bytes following the postbyte. In most cases the programmer need not be concerned with the size of this offset since the assembler will select the optimal size automatically.

Examples of constant-offset indexing are:
 LDA 23, X
 LDX -2, S

LDY 300, X
 LDU CAT, Y

Accumulator-Offset Indexed

This mode is similar to constant offset indexed except that the two's-complement value in one of the accumulators (A, B or D) and the contents of one of the pointer registers are added to form the effective address of the operand. The contents of both the accumulator and the pointer register are unchanged by the addition. The postbyte specifies which accumulator to use as an offset and no additional bytes are required. The advantage of an accumulator offset is that the value of the offset can be calculated by a program at run-time.

Some examples are:
 LDA B, Y
 LDX D, Y
 LEAX B, X

Auto Increment/Decrement Indexed

In the auto increment addressing mode, the pointer register contains the address of the operand. Then, after the pointer register is used it is incremented by one or two. This addressing mode is useful in stepping through tables, moving data, or for the creation of software stacks. In auto decrement, the pointer register is decremented prior to use as the address of the data. The use of auto decrement is similar to that of auto increment; but the tables, etc., are scanned from the high to low addresses. The size of the increment/decrement can be either one or two to allow for tables of either 8- or 16-bit data to be accessed and is selectable by the programmer. The pre-



decrement, post-increment nature of these modes allow them to be used to create additional software stacks that behave identically to the U and S stacks.

Some examples of the auto increment/decrement addressing modes are:

```
LDA ,X+
STD ,Y++
LDB ,-Y
LDX ,--S
```

Care should be taken in performing operations on 16-bit pointer registers (X, Y, U, S) where the same register is used to calculate the effective address.

Consider the following instruction:

```
STX 0, X++ (X initialized to 0)
```

The desired result is to store a 0 in locations \$0000 and \$0001 then increment X to point to \$0002. In reality, the following occurs:

```
0 → temp    calculate the EA; temp is a holding register
X + 2 → X   perform autoincrement
X → (temp)  do store operation
```

• Indexed Indirect

All of the indexing modes with the exception of auto increment/decrement by one, or a ±4-bit offset may have an additional level of indirection specified. In indirect addressing, the effective address is contained at the location specified by the contents of the Index Register plus any offset. In the example below, the A accumulator is loaded indirectly using an effective address calculated from the Index Register and an offset.

	Before Execution	
	A = XX (don't care)	
	X = \$F000	
\$0100	LDA [\$10, X]	EA is now \$F010
\$F010	\$F1	\$F150 is now the
\$F011	\$50	new EA
\$F150	SAA	
	After Execution	
	A = \$AA (Actual Data Loaded)	
	X = \$F000	

All modes of indexed indirect are included except those which are meaningless (e.g., auto increment/decrement by 1 indirect). Some examples of indexed indirect are:

```
LDA [, X]
LDD [, 10, S]
LDA [, B, Y]
LDD [, X + + ]
```

• Relative Addressing

The byte(s) following the branch opcode is (are) treated as a signed offset which may be added to the program counter. If the branch condition is true then the calculated address (PC + signed offset) is loaded into the program counter. Program execution continues at the new location as indicated by the PC; short (1 byte offset) and long (2 bytes offset) relative addressing modes are available. All of memory can be reached in long relative addressing as an effective address is interpreted modulo 2^{16} . Some examples of relative addressing are:

```
BEQ      CAT      (short)
BGT      DOG      (short)
```

```
CAT      LB EQ     RAT      (long)
DOG      LB GT     RABBIT   (long)
.
.
.
RAT      NOP
RABBIT   NOP
```

• Program Counter Relative

The PC can be used as the pointer register with 8 or 16-bit signed offsets. As in relative addressing, the offset is added to the current PC to create the effective address. The effective address is then used as the address of the operand or data. Program Counter Relative Addressing is used for writing position independent programs. Tables related to a particular routine will maintain the same relationship after the routine is moved, if referenced relative to the Program Counter. Examples are:

```
LDA CAT, PCR
LEAX TABLE, PCR
```

Since program counter relative is a type of indexing, an additional level of indirection is available.

```
LDA [CAT, PCR]
LDU [DOG, PCR]
```

■ HD6309E INSTRUCTION SET

The instruction set of the HD6309E is similar to that of the HD6800 and is upward compatible at the source code level. The number of opcodes has been reduced from 72 to 59, but because of the expanded architecture and additional addressing modes, the number of available opcodes (with different addressing modes) has risen from 197 to 1464.

Some of the instructions are described in detail below:

• PSHU/PSHS

The push instructions have the capability of pushing onto either the hardware stack (S) or user stack (U) any single register, or set of registers with a single instruction.

• PULU/PULS

The pull instructions have the same capability of the push instruction, in reverse order. The byte immediately following the push or pull opcode determines which register or registers are to be pushed or pulled. The actual PUSH/PULL sequence is fixed; each bit defines a unique register to push or pull, as shown in below.

PUSH/PULL POST BYTE

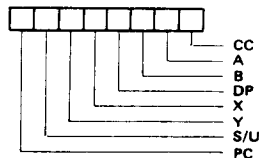

	← Pull Order	Push Order →
PC	U Y X	DP B A CC
FFFF	← increasing memory address 0000
PC	S Y X	DP B A CC



● **TFR/EXG**

Within the HD6309E, any register may be transferred to or exchanged with another of like-size; i.e., 8-bit to 8-bit or 16-bit to 16-bit. Bits 4~7 of postbyte define the source register, while bits 0~3 represent the destination register. These are denoted as follows:

0000 - D	0101 - PC
0001 - X	1000 - A
0010 - Y	1001 - B
0011 - U	1010 - CC
0100 - S	1011 - DP

(NOTE) All other combinations are undefined and INVALID.

TRANSFER/EXCHANGE POST BYTE

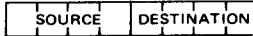

● **LEAX/LEAY/LEAU/LEAS**

The LEA (Load Effective Address) works by calculating the effective address used in an indexed instruction and stores that address value, rather than the data at that address, in a pointer register. This makes all the features of the internal addressing hardware available to the programmer. Some of the implications of this instruction are illustrated in Table 3.

The LEA instruction also allows the user to access data in a position independent manner. For example:

```

LEAX MSG1, PCR
LBSR  PDATA (Print message routine)
.
.
MSG1 FCC 'MESSAGE'
```

This sample program prints: 'MESSAGE'. By writing MSG1, PCR, the assembler computes the distance between the present address and MSG1. This result is placed as a constant into the LEAX instruction which will be indexed from the PC value at the time of execution. No matter where the code is located, when it is executed, the computed offset from the PC will put the absolute address of MSG1 into the X pointer register. This code is totally position independent.

The LEA instructions are very powerful and use an internal holding register (temp). Care must be exercised when using the LEA instructions with the autoincrement and autodecrement addressing modes due to the sequence of internal operations. The LEA internal sequence is outlined as follows:

- LEAa, b+ (any of the 16-bit pointer registers X, Y, U or S may be substituted for a and b.)
 1. b → temp (calculate the EA)
 2. b + 1 → b (modify b, postincrement)
 3. temp → a (load a)
- LEAa, - b
 1. b - 1 → temp (calculate EA with predecrement)
 2. b - 1 → b (modify b, predecrement)
 3. temp → a (load a)

Autoincrement-by-two and autodecrement-by-two instructions work similarly. Note that LEAX, X+ does not change X, however LEAX, -X does decrement X. LEAX 1, X should be used to increment X by one.

Table 3 LEA Examples

Instruction	Operation	Comment
LEAX 10, X	X + 10 → X	Adds 5-bit constant 10 to X
LEAX 500, X	X + 500 → X	Adds 16-bit constant 500 to X
LEAY A, Y	Y + A → Y	Adds 8-bit A accumulator to Y
LEAY D, Y	Y + D → Y	Adds 16-bit D accumulator to Y
LEAU -10, U	U - 10 → U	Subtracts 10 from U
LEAS -10, S	S - 10 → S	Used to reserve area on stack
LEAS 10, S	S + 10 → S	Used to 'clean up' stack
LEAX 5, S	S + 5 → X	Transfers as well as adds

● **MUL**

Multiplies the unsigned binary numbers in the A and B accumulator and places the unsigned result into the 16-bit D accumulator. This unsigned multiply also allows multiple-precision multiplications.

Long and Short Relative Branches

The HD6309E has the capability of program counter relative branching throughout the entire memory map. In this mode, if the branch is to be taken, the 8 or 16-bit signed offset is added to the value of the program counter to be used as the effective address. This allows the program to branch anywhere in the 64k memory map. Position independent code can be easily generated through the use of relative branching. Both short (8-bit) and long (16-bit) branches are available.

● **SYNC**

After encountering a Sync instruction, the MPU enters a Sync state, stops processing instructions and waits for an interrupt. If the pending interrupt is non-maskable (NMI) or maskable (FIRQ, IRQ) with its mask bit (F or I) clear, the processor will clear the Sync state and perform the normal interrupt stacking and service routine. Since FIRQ and IRQ are not edge-triggered, a low level with a minimum duration of three bus cycles is required to assure that the interrupt will be taken. If the pending interrupt is maskable (FIRQ, IRQ) with its mask bit (F or I) set, the processor will clear the Sync state and continue processing by executing the next inline instruction. Figure 17 depicts Sync timing.

Software Interrupts

A Software Interrupt is an instruction which will cause an interrupt, and its associated vector fetch. These Software Interrupts are useful in operating system calls, software debugging, trace operations, memory mapping, and software development systems. Three levels of SWI are available on this HD6309E, and are prioritized in the following order: SWI, SWI2, SWI3.

16-Bit Operation

The HD6309E has the capability of processing 16-bit data. These instructions include loads, stores, compares, adds, subtracts, transfers, exchanges, pushes and pulls.

■ **CYCLE-BY-CYCLE OPERATION**

The address bus cycle-by-cycle performance chart illustrates the memory-access sequence corresponding to each possible instruction and addressing mode in the HD6309E. Each instruction begins with an opcode fetch. While that opcode is being internally decoded, the next program byte is always fetched. (Most instructions will use the next byte, so this



technique considerably speeds throughput.) Next, the operation of each opcode will follow the flow chart. VMA is an indication of FFFF₁₆ on the address bus, R/W = "High" and BS = "Low". The following examples illustrate the use of the chart; see Figure 18.

Example 1: LBSR (Branch Taken)
Before Execution SP = F000

	.		
	.		
\$8000	LBSR	CAT	
	.		
	.		
\$A000	CAT		

CYCLE-BY-CYCLE FLOW

Cycle #	Address	Data	R/W	Description
1	8000	17	1	Opcode Fetch
2	8001	1F	1	Offset High Byte
3	8002	FD	1	Offset Low Byte
4	FFFF	*	1	VMA Cycle
5	FFFF	*	1	VMA Cycle
6	FFFF	*	1	VMA Cycle
7	FFFF	*	1	VMA Cycle
8	EFFF	03	0	Stack Low Order Byte of Return Address
9	EFFE	80	0	Stack High Order Byte of Return Address

Example 2: DEC (Extended)

\$8000	DEC	\$A000
\$A000	FCB	\$80

CYCLE-BY-CYCLE FLOW

Cycle #	Address	Data	R/W	Description
1	8000	7A	1	Opcode Fetch
2	8001	A0	1	Operand Address, High Byte
3	8002	00	1	Operand Address, Low Byte
4	FFFF	*	1	VMA Cycle
5	A000	80	1	Read the Data
6	FFFF	*	1	VMA Cycle
7	A000	7F	0	Store the Decre- mented Data

* The data bus has the data at that particular address.

■ SLEEP MODE

During the interrupt wait period in the SYNC instruction (the SYNC state) and that period in the CWAI instruction (the WAIT state), MPU operation is halted and goes to the sleep mode. However, the state of I/O pins is the same as that of the HD6809E in this mode.

■ HD6309E INSTRUCTION SET TABLES

The instructions of the HD6309E have been broken down into five different categories. They are as follows:

- 8-Bit operation (Table 4)
- 16-Bit operation (Table 5)
- Index register/stack pointer instructions (Table 6)
- Relative branches (long or short) (Table 7)
- Miscellaneous instructions (Table 8)

HD6309E instruction set tables and Hexadecimal Values of instructions are shown in Table 9 and Table 10.



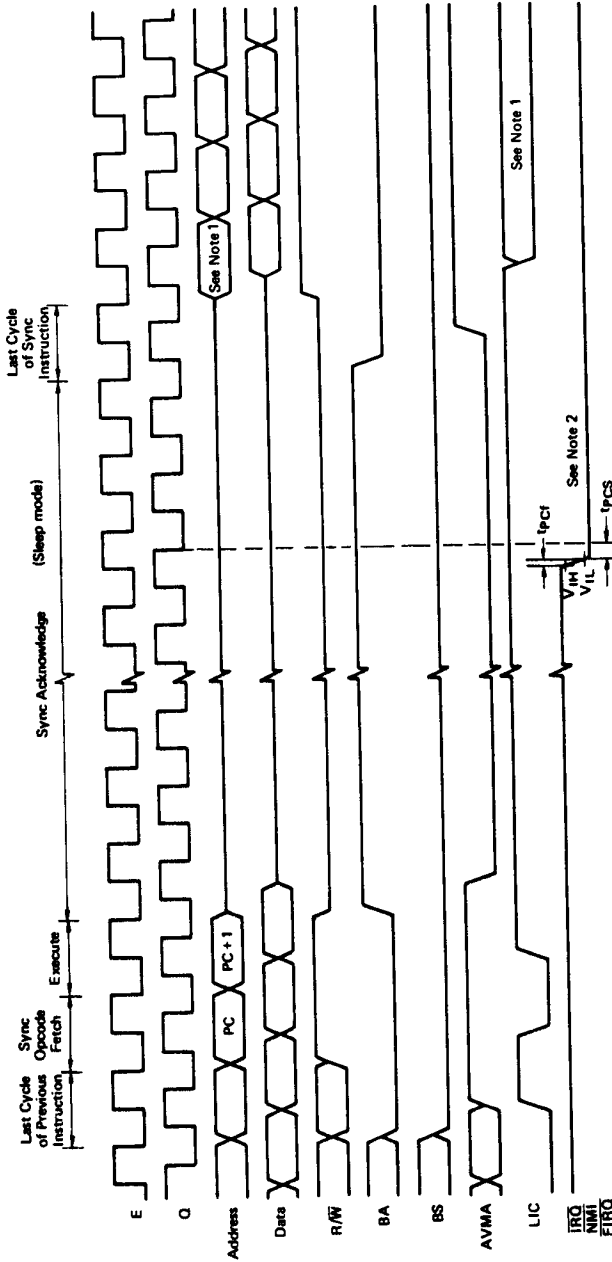

- (NOTES) 1. If the associated mask bit is set when the interrupt is requested, LIC will go "Low", and this cycle will be an instruction fetch from address location PC + 1. However, if the interrupt is accepted (NMI or an unmasked FIRQ or IRQ) LIC will remain "High" and interrupt processing will start with this cycle as (m) on Figure 9 and 10 (Interrupt Timing).
2. If mask bits are clear, IRQ and FIRQ must be held "Low" for three cycles to guarantee that interrupt will be taken, although only one cycle is necessary to bring the processor out of SYNC.
3. Waveform measurements for all inputs and outputs are specified at logic "High" = V_{IHmin} and logic "Low" = V_{ILmax} unless otherwise specified.

Figure 17 SYNC Timing

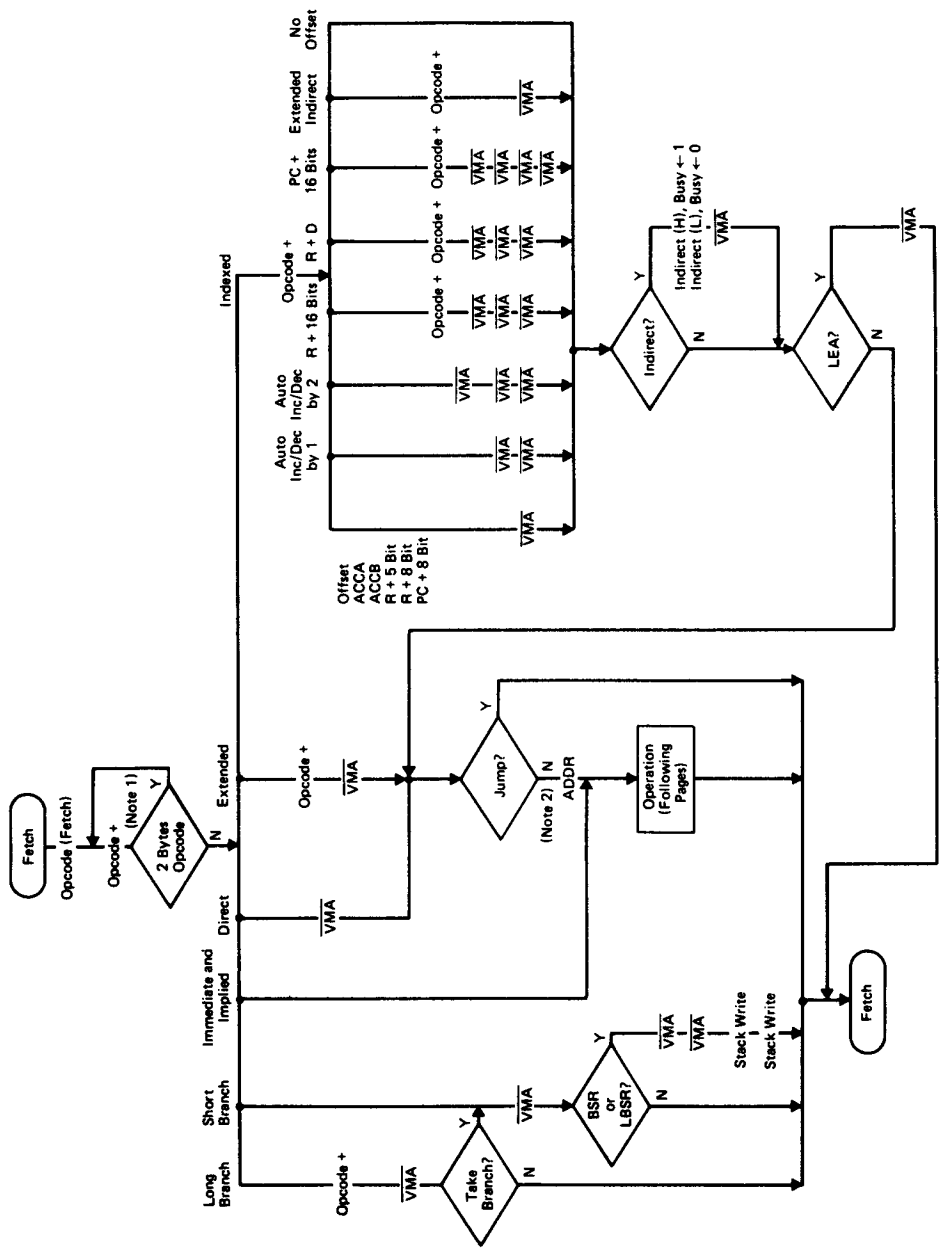

(NOTE)
 1. Busy = "High" during access of first byte of double byte immediate load.
 2. Write operation during store instruction. Busy = "High" during first two cycles of a double-byte access and the first cycle of read-modify-write access.
 3. AVMA is asserted on the cycle before a VMA cycle.

Figure 18 Address Bus Cycle-by-Cycle Performance



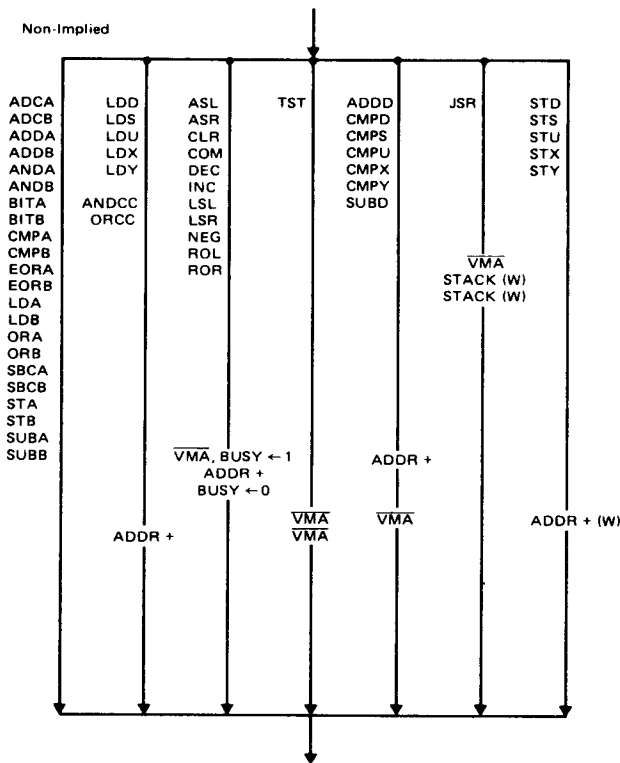

(NOTES)

- Stack (W) refers to the following sequence: $SP \leftarrow SP - 1$, then $ADDR \leftarrow SP$ with $R/\bar{W} = \text{"Low"}$
Stack (R) refers to the following sequence: $ADDR \leftarrow$ with $R/\bar{W} = \text{"High"}$, then $SP \leftarrow SP + 1$.
PSHU, PULU instructions use the user stack pointer (i.e., $SP = U$) and PSHS, PULS use the hardware stack pointer (i.e., $SP = S$).
- Vector refers to the address of an interrupt or reset vector (see Table 1).
- The number of stack accesses will vary according to the number of bytes saved.
- VMA cycles will occur until an interrupt occurs.

Figure 18 Address Bus Cycle-by-Cycle Performance (Continued)

Table 4 8-Bit Accumulator and Memory Instructions

Mnemonic(s)	Operation
ADCA, ADCB	Add memory to accumulator with carry
ADDA, ADDB	Add memory to accumulator
ANDA, ANDB	And memory with accumulator
ASL, ASLA, ASLB	Arithmetic shift of accumulator or memory left
ASR, ASRA, ASRB	Arithmetic shift of accumulator or memory right
BITA, BITB	Bit test memory with accumulator
CLR, CLRA, CLRB	Clear accumulator or memory location
CMPA, CMPB	Compare memory from accumulator
COM, COMA, COMB	Complement accumulator or memory location
DAA	Decimal adjust A accumulator
DEC, DECA, DECB	Decrement accumulator or memory location
EORA, EORB	Exclusive or memory with accumulator
EXG R1, R2	Exchange R1 with R2 (R1, R2 = A, B, CC, DP)
INC, INCA, INCB	Increment accumulator or memory location
LDA, LDB	Load accumulator from memory
LSL, LSLA, LSLB	Logical shift left accumulator or memory location
LSR, LSRA, LSRB	Logical shift right accumulator or memory location



(Continued)

Table 4 8-Bit Accumulator and Memory Instructions (Continued)

Mnemonic(s)	Operation
MUL	Unsigned multiply ($A \times B \rightarrow D$)
NEG, NEGA, NEGB	Negate accumulator or memory
ORA, ORB	Or memory with accumulator
ROL, ROLA, ROLB	Rotate accumulator or memory left
ROR, RORA, RORB	Rotate accumulator or memory right
SBCA, SBCB	Subtract memory from accumulator with borrow
STA, STB	Store accumulator to memory
SUBA, SUBB	Subtract memory from accumulator
TST, TSTA, TSTB	Test accumulator or memory location
TFR R1, R2	Transfer R1 to R2 (R1, R2 = A, B, CC, DP)

(NOTE) A, B, CC or DP may be pushed to (pulled from) either stack with PSHS, PSHU (PULS, PULU) instructions.

Table 5 16-Bit Accumulator and Memory Instructions

Mnemonic(s)	Operation
ADD	Add memory to D accumulator
CMPD	Compare memory from D accumulator
EXG D, R	Exchange D with X, Y, S, U or PC
LDD	Load D accumulator from memory
SEX	Sign Extend B accumulator into A accumulator
STD	Store D accumulator to memory
SUBD	Subtract memory from D accumulator
TFR D, R	Transfer D to X, Y, S, U or PC
TFR R, D	Transfer X, Y, S, U or PC to D

(NOTE) D may be pushed (pulled) to either stack with PSHS, PSHU (PULS, PULU) instructions.

Table 6 Index Register Stack Pointer Instructions

Mnemonic(s)	Operation
CMPS, CMPU	Compare memory from stack pointer
CMPX, CMPY	Compare memory from index register
EXG R1, R2	Exchange D, X, Y, S, U or PC with D, X, Y, S, U or PC
LEAS, LEAU	Load effective address into stack pointer
LEAX, LEAY	Load effective address into index register
LDS, LDU	Load stack pointer from memory
LDX, LDY	Load index register from memory
PSHS	Push A, B, CC, DP, D, X, Y, U, or PC onto hardware stack
PSHU	Push A, B, CC, DP, D, X, Y, S, or PC onto user stack
PULS	Pull A, B, CC, DP, D, X, Y, U or PC from hardware stack
PULU	Pull A, B, CC, DP, D, X, Y, S or PC from user stack
STS, STU	Store stack pointer to memory
STX, STY	Store index register to memory
TFR R1, R2	Transfer D, X, Y, S, U or PC to D, X, Y, S, U or PC
ABX	Add B accumulator to X (unsigned)

2



Table 7 Branch Instructions

Mnemonic(s)	Operation
SIMPLE BRANCHES	
BEQ, LBEQ	Branch if equal
BNE, LBNE	Branch if not equal
BMI, LBMI	Branch if minus
BPL, LBPL	Branch if plus
BCS, LBCS	Branch if carry set
BCC, LBCC	Branch if carry clear
BVS, LBVS	Branch if overflow set
BVC, LBVC	Branch if overflow clear
SIGNED BRANCHES	
BGT, LBGT	Branch if greater (signed)
BGE, LBGE	Branch if greater than or equal (signed)
BEQ, LBEQ	Branch if equal
BLE, LBLE	Branch if less than or equal (signed)
BLT, LBLT	Branch if less than (signed)
UNSIGNED BRANCHES	
BHI, LBHI	Branch if higher (unsigned)
BHS, LBHS	Branch if higher or same (unsigned)
BEQ, LBEQ	Branch if equal
BLS, LBLs	Branch if lower or same (unsigned)
BLO, LBLO	Branch if lower (unsigned)
OTHER BRANCHES	
BSR, LBSR	Branch to subroutine
BRA, LBRA	Branch always
BRN, LBRN	Branch never

Table 8 Miscellaneous Instructions

Mnemonic(s)	Operation
ANDCC	AND condition code register
CWAI	AND condition code register, then wait for interrupt
NOP	No operation
ORCC	OR condition code register
JMP	Jump
JSR	Jump to subroutine
RTI	Return from interrupt
RTS	Return from subroutine
SWI, SWI2, SWI3	Software interrupt (absolute indirect)
SYNC	Synchronize with interrupt line



Table 9. HD6309E Instruction Set Table

INSTRUCTIONS/ FORMS	MP REG		DIRECT		EXTND		IMMED		INDEX		RELATIVE		DESCRIPTION	7	6	5	4	3	2	1	0						
	OP	#	OP	#	OP	#	OP	#	OP	#	OP	#			E	F	H	I	N	Z	V	C					
ABX	3A	3	1										B + X → X (UNSIGNED)	●	●	●	●	●	●	●	●						
ADC	ADCA			99	4	2	B9	5	3	89	2	2	A9	4	+	2	+	A + M + C → A	●	●	1	1	1	1	1	1	
	ADCB			D9	4	2	F9	5	3	C9	2	2	E9	4	+	2	+	B + M + C → B	●	●	1	1	1	1	1	1	
ADD	ADDA			9B	4	2	BB	5	3	8B	2	2	AB	4	+	2	+	A + M → A	●	●	1	1	1	1	1	1	
	ADDB			DB	4	2	FB	5	3	CB	2	2	EB	4	+	2	+	B + M → B	●	●	1	1	1	1	1	1	
	ADDD			D3	6	2	F3	7	3	C3	4	3	E3	6	+	2	+	D + M: M + 1 → D	●	●	1	1	1	1	1	1	
AND	ANDA			94	4	2	B4	5	3	84	2	2	A4	4	+	2	+	A ∧ M → A	●	●	●	●	1	1	R	●	
	ANDB			D4	4	2	F4	5	3	C4	2	2	E4	4	+	2	+	B ∧ M → B	●	●	●	●	1	1	R	●	
	ANDCC									1C	3	2						C C ∧ IMM → C C	(⊕)	
ASL	ASLA	48	2	1														A	●	●	⊕	1	1	1	1	1	
	ASLB	58	2	1														B	●	●	⊕	1	1	1	1	1	
	ASL				08	6	2	78	7	3			68	6	+	2	+	M	●	●	⊕	1	1	1	1	1	
																		C	●	●	⊕	1	1	1	1	1	
ASR	ASRA	47	2	1														A	●	●	⊕	1	1	1	1	1	
	ASRB	57	2	1														B	●	●	⊕	1	1	1	1	1	
	ASR				07	6	2	77	7	3			67	6	+	2	+	M	●	●	⊕	1	1	1	1	1	
																		b ₇								b ₀	C
BCC	BCC												24	3	2			Branch C = 0	●	●	●	●	●	●	●	●	
	LBCC												10	5(6)	4			Long Branch	●	●	●	●	●	●	●	●	
													24					C = 0									
BCS	BCS												25	3	2			Branch C = 1	●	●	●	●	●	●	●	●	
	LBCS												10	5(6)	4			Long Branch	●	●	●	●	●	●	●	●	
													25					C = 1									
BEQ	BEQ												27	3	2			Branch Z = 1	●	●	●	●	●	●	●	●	
	LBEQ												10	5(6)	4			Long Branch	●	●	●	●	●	●	●	●	
													27					Z = 1									
BGE	BGE												2C	3	2			Branch N ⊕ V = 0	●	●	●	●	●	●	●	●	
	LBGE												10	5(6)	4			Long Branch	●	●	●	●	●	●	●	●	
													2C					N ⊕ V = 0									
BGT	BGT												2E	3	2			Branch Z V (N ⊕ V) = 0	●	●	●	●	●	●	●	●	
	LBGT												10	5(6)	4			Long Branch	●	●	●	●	●	●	●	●	
													2E					Z V (N ⊕ V) = 0									
BHI	BHI												22	3	2			Branch C V Z = 0	●	●	●	●	●	●	●	●	
	LBHI												10	5(6)	4			Long Branch	●	●	●	●	●	●	●	●	
													22					C V Z = 0									
BHS	BHS												24	3	2			Branch C = 0	●	●	●	●	●	●	●	●	
	LBHS												10	5(6)	4			Long Branch	●	●	●	●	●	●	●	●	
													24					C = 0									
BIT	BITA			95	4	2	B5	5	3	85	2	2	A5	4	+	2	+	Bit Test A (M ∧ A)	●	●	●	●	1	1	R	●	
	BITB			D5	4	2	F5	5	3	C5	2	2	E5	4	+	2	+	Bit Test B (M ∧ B)	●	●	●	●	1	1	R	●	
BLE	BLE												2F	3	2			Branch Z V (N ⊕ V) = 1	●	●	●	●	●	●	●	●	
	LBLE												10	5(6)	4			Long Branch	●	●	●	●	●	●	●	●	
													2F					Z V (N ⊕ V) = 1									
BLO	BLO												25	3	2			Branch C = 1	●	●	●	●	●	●	●	●	
	LBLO												10	5(6)	4			Long Branch	●	●	●	●	●	●	●	●	
													25					C = 1									
BLS	BLS												23	3	2			Branch C V Z = 1	●	●	●	●	●	●	●	●	
	LBLS												10	5(6)	4			Long Branch	●	●	●	●	●	●	●	●	
													23					C V Z = 1									
BLT	BLT												2D	3	2			Branch N ⊕ V = 1	●	●	●	●	●	●	●	●	
	LBLT												10	5(6)	4			Long Branch	●	●	●	●	●	●	●	●	
													2D					N ⊕ V = 1									
BMI	BMI												2B	3	2			Branch N = 1	●	●	●	●	●	●	●	●	
	LBMI												10	5(6)	4			Long Branch	●	●	●	●	●	●	●	●	
													2B					N = 1									

(Continued)



INSTRUCTIONS/ FORMS	MP ACCM		DIRECT		EXTND		IMMED		INDEX		RELATIVE		DESCRIPTION	7	6	5	4	3	2	1	0	
	OP	#	OP	#	OP	#	OP	#	OP	#	OP	#		E	F	H	I	N	Z	V	C	
BNE	BNE											2 6	3 2	Branch	Z = 0	●	●	●	●	●	●	●
	LBNE											1 0	5(6) 4	Long Branch		●	●	●	●	●	●	
												2 6		Z = 0		●	●	●	●	●	●	
HPL	HPL											2 A	3 2	Branch	N = 0	●	●	●	●	●	●	
	LBPL											1 0	5(6) 4	Long Branch		●	●	●	●	●	●	
												2 A		N = 0		●	●	●	●	●	●	
BRA	BRA											2 0	3 2	Branch Always		●	●	●	●	●	●	
	LBRA											1 6	5 3	Long Branch Always		●	●	●	●	●	●	
BRN	BRN											2 1	3 2	Branch Never		●	●	●	●	●	●	
	LBRN											1 0	5 4	Long Branch Never		●	●	●	●	●	●	
												2 1				●	●	●	●	●	●	
HSR	HSR											8 D	7 2	Branch to		●	●	●	●	●	●	
														Subroutine		●	●	●	●	●	●	
	LBSR											1 7	9 3	Long Branch to		●	●	●	●	●	●	
														Subroutine		●	●	●	●	●	●	
HVC	HVC											2 8	3 2	Branch	V = 0	●	●	●	●	●	●	
	LBVC											1 0	5(6) 4	Long Branch		●	●	●	●	●	●	
												2 8		V = 0		●	●	●	●	●	●	
HVS	HVS											2 9	3 2	Branch	V = 1	●	●	●	●	●	●	
	LBVS											1 0	5(6) 4	Long Branch		●	●	●	●	●	●	
												2 9		V = 1		●	●	●	●	●	●	
CLR	CLRA	4 F	2 1											0 → A	●	●	●	●	R	S	R	
	CLRB	5 F	2 1											0 → B	●	●	●	●	R	S	R	
				0 F	6 2	7 F	7 3					6 F	6 + 2 +	0 → M	●	●	●	●	R	S	R	
CMP	CMPA			9 1	4 2	B 1	5 3	8 1	2 2	A 1	4 + 2 +			Compare M from A	●	●	Ⓢ	●	1	1	1	
	CMPB			D 1	4 2	F 1	5 3	C 1	2 2	E 1	4 + 2 +			Compare M from B	●	●	Ⓢ	●	1	1	1	
	CMPD			1 0	7 3	1 0	8 4	1 0	5 4	1 0	7 + 3 +			Compare M:M + 1	●	●	●	●	1	1	1	
				9 3		B 3		8 3		A 3				from D	●	●	●	●	1	1	1	
	CMPS			1 1	7 3	1 1	8 4	1 1	5 4	1 1	7 + 3 +			Compare M:M + 1	●	●	●	●	1	1	1	
				9 C		B C		8 C		A C				from S	●	●	●	●	1	1	1	
	CMPU			1 1	7 3	1 1	8 4	1 1	5 4	1 1	7 + 3 +			Compare M:M + 1	●	●	●	●	1	1	1	
				9 3		B 3		8 3		A 3				from U	●	●	●	●	1	1	1	
	CMPX			9 C	6 2	B C	7 3	8 C	4 3	A C	6 + 2 +			Compare M:M + 1	●	●	●	●	1	1	1	
														from X	●	●	●	●	1	1	1	
	CMPY			1 0	7 3	1 0	8 4	1 0	5 4	1 0	7 + 3 +			Compare M:M + 1	●	●	●	●	1	1	1	
				9 C		B C		8 C		A C				from Y	●	●	●	●	1	1	1	
COM	COMA	4 3	2 1											A → A	●	●	●	●	1	1	R	
	COMB	5 3	2 1											B → B	●	●	●	●	1	1	R	
	COM			0 3	6 2	7 3	7 3				6 3	6 + 2 +		M → M	●	●	●	●	1	1	R	
CWAI								3 C	≥ 20	2				CC ^ IMM → CC:	S	(Ⓢ)	
														Wait for Interrupt								
DAA		1 9	2 1											Decimal Adjust A	●	●	●	●	1	1	Ⓢ	
DEC	DECA	4 A	2 1											A - 1 → A	●	●	●	●	1	1	1	
	DECB	5 A	2 1											B - 1 → B	●	●	●	●	1	1	1	
				0 A	6 2	7 A	7 3				6 A	6 + 2 +		M - 1 → M	●	●	●	●	1	1	1	
EOR	EORA			9 8	4 2	B 8	5 3	8 8	2 2	A 8	4 + 2 +			A ⊕ M → A	●	●	●	●	1	1	1	
	EORH			D 8	4 2	F 8	5 3	C 8	2 2	E 8	4 + 2 +			B ⊕ M → B	●	●	●	●	1	1	R	
EXG	R1, R2	1 E	H 2											R1 ↔ R2	(Ⓢ)	
INC	INCA	4 C	2 1											A + 1 → A	●	●	●	●	1	1	1	
	INCB	5 C	2 1											B + 1 → B	●	●	●	●	1	1	1	
				0 C	6 2	7 C	7 3				6 C	6 + 2 +		M + 1 → M	●	●	●	●	1	1	1	
JMP				0 E	3 2	7 E	4 3				6 E	3 + 2 +		EA ⊕ → PC	●	●	●	●	1	1	1	
JSR				9 D	7 2	H D	H 3				A D	7 + 2 +		Jump to Subroutine	●	●	●	●	●	●	●	

(Continued)



INSTRUCTIONS/ FORMS	ACCUM REGS		DIRECT		EXTND		IMMED		INDEX		RELATIVE		DESCRIPTION	7	6	5	4	3	2	1	0												
	OP	#	OP	#	OP	#	OP	#	OP	#	OP	#		E	F	H	I	N	Z	V	C												
LD	LDA		9	6	4	2	B	6	5	3	8	6	2	2	A	6	4	+	2			M→A	●	●	●	●	1	1	R	●			
	LDB		D	6	4	2	F	6	5	3	C	6	2	2	E	6	4	+	2				M→B	●	●	●	●	1	1	R	●		
	LDD		D	C	5	2	F	C	6	3	C	C	3	3	E	C	5	+	2				M:M+1→D	●	●	●	●	1	1	R	●		
	LDS		1	0	6	3	1	0	7	4	1	0	4	4	1	0	6	+	3				M:M+1→S	●	●	●	●	1	1	R	●		
		DE					F	E			C	E			E								M:M+1→U	●	●	●	●	1	1	R	●		
	LDU		D	E	5	2	F	E	6	3	C	E	3	3	E	E	5	+	2				M:M+1→X	●	●	●	●	1	1	R	●		
	LDX		9	E	5	2	B	E	6	3	8	E	3	3	A	E	5	+	2				M:M+1→Y	●	●	●	●	1	1	R	●		
	LDY		1	0	6	3	1	0	7	4	1	0	4	4	1	0	6	+	3														
		9E					B	E			8	E			A	E							EA③→S	●	●	●	●	●	●	●	●		
																							EA③→U	●	●	●	●	●	●	●	●		
LEA	LEAS																					EA③→X	●	●	●	●	●	●	●	●			
	LEAU																					EA③→Y	●	●	●	●	●	●	●	●			
	LEAX																																
	LEAY																																
LSL	LSLA	48	2	1																													
	LSLB	58	2	1																													
	LSL		0	8	6	2	7	8	7	3					6	8	6	+	2														
LSR	LSRA	44	2	1																													
	LSRB	54	2	1																													
	LSR		0	4	6	2	7	4	7	3					6	4	6	+	2														
MUL		3	D	1	1																												
NEG	NEGA	4	0	2	1																												
	NEGB	5	0	2	1																												
	NEG		0	0	6	2	7	0	7	3					6	0	6	+	2														
NOP		1	2	2	1																												
OR	ORA		9	A	4	2	B	A	5	3	8	A	2	2	A	A	4	+	2														
	ORB		D	A	4	2	F	A	5	3	C	A	2	2	E	A	4	+	2														
	ORCC										1	A	3	2																			
PSH	PSHS	3	4	5	2																												
	PSHU	3	6	5	2																												
PUL	PULS	3	5	5	2																												
	PULU	3	7	5	2																												
ROL	ROLA	4	9	2	1																												
	ROLB	5	9	2	1																												
	ROL		0	9	6	2	7	9	7	3					6	9	6	+	2														
ROR	RORA	4	6	2	1																												
	RORB	5	6	2	1																												
	ROR		0	6	6	2	7	6	7	3					6	6	6	+	2														
RTI		3	B	6/15	1																												
RTS		3	9	5	1																												
SBC	SBCA		9	2	4	2	B	2	5	3	8	2	2	A	2	4	+	2															
	SBCB		D	2	4	2	F	2	5	3	C	2	2	E	2	4	+	2															
SEX		1	D	2	1																												



(Continued)



INSTRUCTIONS/ FORMS	MPU ACCUM REG		DIRECT			EXTND			IMMED			INDEX①		RELATIVE		DESCRIPTION	7	6	5	4	3	2	1	0	
	OP	#	OP	#	OP	#	OP	#	OP	#	OP	#	OP	#	OP		#	E	F	H	I	N	Z	V	C
ST	STA		97	4	2	B7	5	3				A7	4+2+				●	●	●	●	1	1	R	●	
	STB		D7	4	2	F7	5	3				E7	4+2+				●	●	●	●	1	1	R	●	
	STD		DD	5	2	FD	6	3				ED	5+2+				●	●	●	●	1	1	R	●	
	STS			10	6	3	10	7	4				10	6+3+				●	●	●	●	1	1	R	●
		DF					FF						EF					●	●	●	●	1	1	R	●
	STU		DF	5	2	FF	6	3				EF	5+2+				●	●	●	●	1	1	R	●	
	STX		9F	5	2	BF	6	3				AF	5+2+				●	●	●	●	1	1	R	●	
	STY			10	6	3	10	7	4				10	6+3+				●	●	●	●	1	1	R	●
		9F					BF						AF					●	●	●	●	1	1	R	●
	SUB	SUBA		90	4	2	B0	5	3	80	2	2	A0	4+2+				●	●	⊕	●	1	1	1	1
SUBB			D0	4	2	F0	5	3	C0	2	2	E0	4+2+				●	●	⊕	●	1	1	1	1	
SUBD			93	6	2	B3	7	3	B3	4	3	A3	6+2+				●	●	●	●	1	1	1	1	
SWI	SWI⑥	3F	19	1													S	S	●	S	1	1	1	1	
	SWI2⑥	10	20	2													S	●	●	●	●	●	●	●	
SWI3⑥		3F															S	●	●	●	●	●	●	●	
	SWI3⑥	11	20	2													S	●	●	●	●	●	●	●	
SYNC		13	≥4	1													●	●	●	●	●	●	●	●	
TFR	R1, R2	1F	6	2													(⊕)	
TST	TSTA	4D	2	1													●	●	●	●	1	1	R	●	
	TSTB	5D	2	1													●	●	●	●	1	1	R	●	
	TST		0D	6	2	7D	7	3				6D	6+2+				●	●	●	●	1	1	R	●	

(NOTES)

- (1) This column gives a base cycle and byte count. To obtain total count, and the values obtained from the INDEXED ADDRESSING MODES table.
- (2) R1 and R2 may be any pair of 8 bit or any pair of 16 bit registers.
The 8 bit registers are: A, B, CC, DP
The 16 bit registers are: X, Y, U, S, D, PC
- ③ EA is the effective address.
- ④ The PSH and PUL instructions require 5 cycle plus 1 cycle for each byte pushed or pulled.
- ⑤ 5(6) means: 5 cycles if branch not taken, 6 cycles if taken.
- ⑥ SWI sets 1 and F bits. SWI2 and SWI3 do not affect I and F.
- ⑦ Conditions Codes set as a direct result of the instruction.
- ⑧ Value of half-carry flag is undefined.
- ⑨ Special Case - Carry set if b7 is SET.
- ⊕ Condition Codes set as a direct result of the instruction if CC is specified, and not affected otherwise.

LEGEND:

- | | | | |
|----|------------------------------|----|---|
| OP | Operation Code (Hexadecimal) | Z | Zero (byte) |
| ~ | Number of MPU Cycles | V | Overflow, 2's complement |
| # | Number of Program Bytes | C | Carry from bit 7 |
| + | Arithmetic Plus | ‡ | Test and set if true, cleared otherwise |
| - | Arithmetic Minus | ● | Not Affected |
| x | Multiply | CC | Condition Code Register |
| M | Complement of M | : | Concatenation |
| → | Transfer Into | V | Logical or |
| H | Half-carry (from bit 3) | ^ | Logical and |
| N | Negative (sign bit) | ⊕ | Logical Exclusive or |



Table 10 Hexadecimal Values of Machine Codes

OP	Mnem	Mode	~	#	OP	Mnem	Mode	~	#	OP	Mnem	Mode	~	#	
00	NEG	Direct	6	2	30	LEAX	Indexed	4+	2+	60	NEG	Indexed	6+	2+	
01	*	↑			31	LEAY	↑	4+	2+	61	*	↑			
02	*				32	LEAS				62	*				
03	COM	↑	6	2	33	LEAU	↑	4+	2+	63	COM	↑	6+	2+	
04	LSR				34	PSHS				64	LSR				
05	*	↑	6	2	35	PULS	↑	5+	2	65	*	↑	6+	2+	
06	ROR				36	PSHU				66	ROR				
07	ASR	↑	6	2	37	PULU	↑	5+	2	67	ASR	↑	6+	2+	
08	ASL, LSL				38	*				68	ASL, LSL				
09	ROL	↑	6	2	39	RTS	↑	5	1	69	ROL	↑	6+	2+	
0A	DEC				3A	ABX				6A	DEC				
0B	*	↑	6	2	3B	RTI	↑	6, 15	1	6B	*	↑	6+	2+	
0C	INC				3C	CWAI				6C	INC				
0D	TST	↑	6	2	3D	MUL	↑	11	1	6D	TST	↑	6+	2+	
0E	JMP				3E	*				6E	JMP				
0F	CLR	Direct	6	2	3F	SWI	Implied	19	1	6F	CLR	Indexed	6+	2+	
10	} See Next Page	-	-	-	40	NEGA	Implied	2	1	70	NEG	Extended	7	3	
11					41	*	↑			71	*	↑			
12	NOP	Implied	2	1	42	*				2	1				72
13	SYNC	Implied	IV	4	43	COMA	2	1	73			COM	↑	7	3
14	*	↑	5	3	44	LSRA			2	1	74	LSR			
15	*				45	*	75	*							
16	LBRA	Relative	9	3	46	RORA	↑	2	1	76	ROR	↑	7	3	
17	LBSR	Relative	9	3	47	ASRA				77	ASR				7
18	*	↑	2	1	48	ASLA, LSLA	↑	2	1	78	ASL, LSL	↑	7	3	
19	DAA				Implied	2				1	49				ROLA
1A	ORCC	Immed	3	2	4A	DECA	↑	2	1	7A	DEC	↑	7	3	
1B	*	↑	3	2	4B	*				7B	*				↑
1C	ANDCC				Immed	3	2	4C	INCA	↑	2	1	7C	INC	
1D	SEX	Implied	2	1	4D	TSTA	↑	2	1				7D	TST	↑
1E	EXG	↑	8	2	4E	*				2	1	7E	JMP	↑	
1F	TFR				Implied	6	2	4F	CLRA			Implied	2		1
20	BRA	↑	3	2	50	NEGB	↑	2	1	80	SUBA	↑	2	2	
21	BRN				Relative	3				2	51				*
22	BHI	↑	3	2	52	*	↑	2	1	82	SBCA	↑	2	2	
23	BLS				3	2				53	COMB				83
24	BHS, BCC	↑	3	2	54	LSRB	↑	2	1	84	ANDA	↑	2	2	
25	BLO, BCS				3	2				55	*				85
26	BNE	↑	3	2	56	RORB	↑	2	1	86	LDA	↑	2	2	
27	BEQ				3	2				57	ASRB				87
28	BVC	↑	3	2	58	ASLB, LSLB	↑	2	1	88	EORA	↑	2	2	
29	BVS				3	2				59	ROLB				89
2A	BPL	↑	3	2	5A	DECB	↑	2	1	8A	ORA	↑	2	2	
2B	BMI				3	2				5B	*				8B
2C	BGE	↑	3	2	5C	INCB	↑	2	1	8C	CMPX	↑	Immed	4	3
2D	BLT				3	2				5D	TSTB				
2E	BGT	↑	3	2	5E	*	↑	2	1	8E	LDX	↑	Immed	3	3
2F	BLE				Relative	3				2	5F				



LEGEND:
 ~ Number of MPU cycles (less possible push pull or indexed-mode cycles)
 # Number of program bytes
 * Denotes unused opcode

(to be continued)



OP	Mnem	Mode	~	#	OP	Mnem	Mode	~	#	OP	Mnem	Mode	~	#		
90	SUBA	Direct	4	2	C6	LDB	Immed	2	2	FC	LDD	Extended	6	3		
91	CMPA		4	2	C7	*		FD	STD	6	3					
92	SBCA		4	2	C8	EORB		FE	LDU	6	3					
93	SUBD		6	2	C9	ADCB		2	2	FF	STU	Extended	6	3		
94	ANDA		4	2	CA	ORB		2	2							
95	BITA		4	2	CB	ADDB		2	2							
96	LDA		4	2	CC	LDD		3	3	2 Bytes Opcode						
97	STA		4	2	CD	*				1021	LBRN	Relative	5	4		
98	EORA		4	2	CE	LDU		Immed	3	3	1022		LBHI	5(6)	4	
99	ADCA		4	2	CF	*			1023	LBSL	5(6)		4			
9A	ORA	4	2			1024	LBHS, LBCC		5(6)	4						
9B	ADDA	4	2	D0	SUBB	Direct	4		2	1025	LBCS, LBLO		5(6)	4		
9C	CMPX	6	2	D1	CMPB		4		2	1026	LBNE		5(6)	4		
9D	JSR	7	2	D2	SBCB		4		2	1027	LBEQ		5(6)	4		
9E	LDX	5	2	D3	ADDD		6		2	1028	LBVC		5(6)	4		
9F	STX	Direct	5	2	D4		ANDB		4	2	1029		LBVS	5(6)	4	
A0	SUBA		Indexed	4+	2+		D5		BITB	4	2		102A	LBPL	5(6)	4
A1	CMPA			4+	2+		D6		LDB	4	2	102B	LBMI	5(6)	4	
A2	SBCA			4+	2+		D7	STB	4	2	102C	LBGE	5(6)	4		
A3	SUBD			6+	2+		D8	EORB	4	2	102D	LBLT	5(6)	4		
A4	ANDA			4+	2+		D9	ADCB	4	2	102E	LBGT	5(6)	4		
A5	BITA			4+	2+	DA	ORB	4	2	102F	LBLE	Relative Implied	20	2		
A6	LDA			4+	2+	DB	ADDB	4	2	103F	SWI2		5	4		
A7	STA			4+	2+	DC	LDD	5	2	1083	CMPD	Immed	5	4		
A8	EORA			4+	2+	DD	STD	5	2	108C	CMPY		5	4		
A9	ADCA	4+		2+	DE	LDU	Direct	5	2	108E	LDY	Immed	4	4		
AA	ORA	4+	2+	DF	STU	5		2	1093	CMPD	Direct		7	3		
AB	ADDA	4+	2+	E0	SUBB	Indexed		4+	2+	109C		CMPY	Direct	7	3	
AC	CMPX	6+	2+	E1	CMPB			4+	2+	109E	LDY	Immed		6	3	
AD	JSR	7+	2+	E2	SBCB			4+	2+	109F	STY		Direct	6	3	
AE	LDX	5+	2+	E3	ADDD			6+	2+	10A3	CMPD	Indexed		7+	3+	
AF	STX	Indexed	5+	2+	E4			ANDB	4+	2+	10AC		CMPY	Immed	7+	3+
B0	SUBA		Extended	5	3			E5	BITB	4+	2+	10AE	LDY		Immed	6+
B1	CMPA			5	3			E6	LDB	4+	2+	10AF	STY	Indexed		6+
B2	SBCA			5	3			E7	STB	4+	2+	10B3	CMPD		Extended	8
B3	SUBD			7	3		E8	EORB	4+	2+	10B4	CMPY	Immed	8		4
B4	ANDA			5	3		E9	ADCB	4+	2+	10BE	LDY		Extended	7	4
B5	BITA			5	3	EA	ORB	4+	2+	10BF	STY	Immed	4		4	
B6	LDA			5	3	EB	ADDB	4+	2+	10CE	LDS		Direct	6	3	
B7	STA			5	3	EC	LDD	5+	2+	10DE	LDS	Direct		6	3	
B8	EORA			5	3	ED	STD	5+	2+	10DF	STS		Immed	6	3	
B9	ADCA	5		3	EE	LDU	5+	2+	10EE	LDS	Indexed	6+		3+		
BA	ORA	5	3	EF	STU	5+	2+	10EF	STS	Extended		6+	3+			
BB	ADDA	5	3	F0	SUBB	Extended	5	3	10FE		LDS	Extended	7	4		
BC	CMPX	7	3	F1	CMPB		5	3	10FF	STS	Implied		20	2		
BD	JSR	8	3	F2	SBCB		5	3	1183	CMPU		Immed	5	4		
BE	LDX	6	3	F3	ADDD		7	3	118C	CMPS	Immed		5	4		
BF	STX	Extended	6	3	F4		ANDB	5	3	1193		CMPU	Direct	7	3	
C0	SUBB		Immed	2	2		F5	BITB	5	3	119C	CMPS		Direct	7	3
C1	CMPB			2	2		F6	LDB	5	3	11A3	CMPU	Indexed		7+	3+
C2	SBCB			2	2		F7	STB	5	3	11AC	CMPS		Extended	7+	3+
C3	ADDD			4	3		F8	EORB	5	3	11B3	CMPU	Extended		8	4
C4	ANDB			2	2		F9	ADCB	5	3	11BC	CMPS		Extended	8	4
C5	BITB			Immed	2	2	FA	ORB	5	3						
								FB	ADDB	5	3					

(NOTE): All unused opcodes are both undefined and illegal



■ NOTE FOR USE
 ● Execution Sequence of CLR Instruction

Example: CLR (Extended)

Cycle #	Address	Data	R/W	Description
1	8000	7F	1	Opcode Fetch
2	8001	A0	1	Operand Address, High Byte
3	8002	00	1	Operand Address, Low Byte
4	FFFF	*	1	VMA Cycle
5	A000	80	1	Read the Data
6	FFFF	*	1	VMA Cycle
7	A000	00	0	Store Fixed "00" into Specified Location

Cycle-by-cycle flow of CLR instruction (Direct, Extended, Indexed Addressing Mode) is shown below. In this sequence the content of the memory location specified by the operand is read before writing "00" into it. Note that status Flags, such as IRQ Flag, will be cleared by this extra data read operation when accessing the control/status register (sharing the same address between read and write) of peripheral devices.

● The Noise of HD6309E at Bus Outputs Changing
 We shall notify you of the noise of the HD6309E.

The noise over 0.8V may appear on the output signals when data bus or address bus outputs change from "High" to "Low". Problems and countermeasure are shown as follows.

(1) The Noise at Data Bus Outputs Changing ("High"→"Low")
 Problem: The noise over 0.8V may appear on A₁₅~A₁₃, R/W outputs change (worst case; \$FF→\$00) as shown in Figure 19.

* The data bus has the data at that particular address.

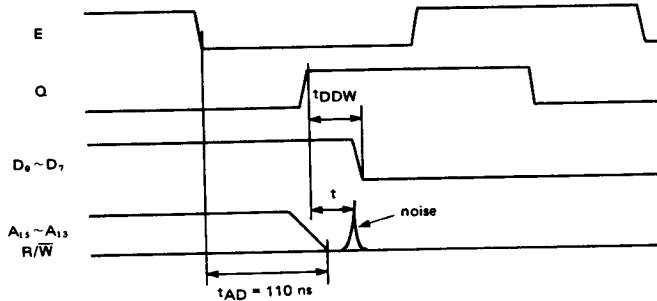

Noise peak (worst case); about 1.5V
 Test condition
 T_a = -20°C
 V_{CC} = 5.5V
 Number of data bus lines switching from "High" to "Low" = 8
 (\$FF→\$00) data bus load capacitance = 130pF

Period of the noise occurrence (reference data)

- t = 6~34ns (T_a = -20°C)
- t = 8~43ns (T_a = 25°C)
- t = 12~54ns (T_a = 75°C)

Figure 19 Noise at data bus output changing

Countermeasure: If the noise level can not be reduced by controlling data bus load capacitance or reducing V_{CC} in your application system, connect damping resistors (about 100~150Ω) to data bus to reduce the noise level as shown in

Figure 20. Table 11 shows the relationship between damping resistors and electrical characteristics. Connecting damping resistors to data bus is effective to reduce the noise level as shown in Figure 21.



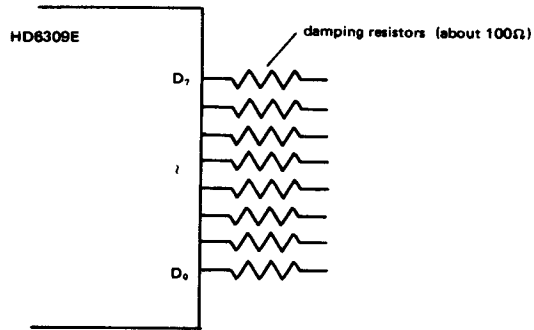

Figure 20 Connecting damping resistors to data bus

Table 11 The relationship between damping resistors and electrical characteristics

			R = 0Ω	R = 100 ~ 150Ω
HD63B09E (2MHz)	t _{DHW}	T _a = -20~0°C	20 ns	10 ns
		T _a = 0~75°C	30 ns	15 ns
HD63C09E (3MHz)	t _{DDW}		70 ns	80 ns
	t _{DHW}	T _a = -20~0°C	20 ns	10 ns
		T _a = 0~75°C	30 ns	15 ns



Test condition
 VCC = 5.5V
 Ta = -20°C
 data bus load capacitance
 = 130pF

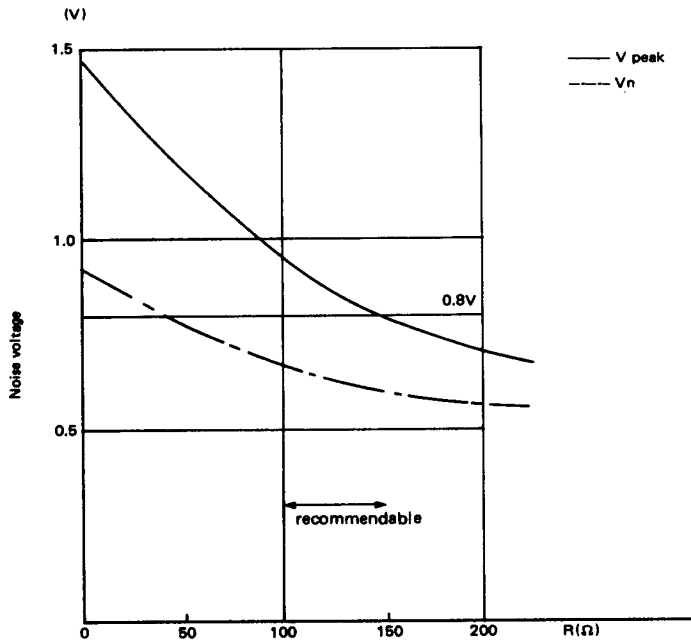
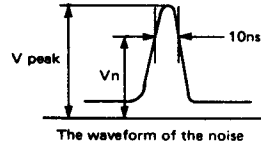

Figure 21 An example of the dependency of the noise voltage on damping resistors

2



2. The Noise at Address Bus Outputs Changing
 ("High" → "Low")

AVMA outputs when address bus outputs change
 (worst case; \$FFFF→\$0000) as shown in Figure 22.

Problem: The noise over 0.8V may appear on BUSY, LIC, AVMA

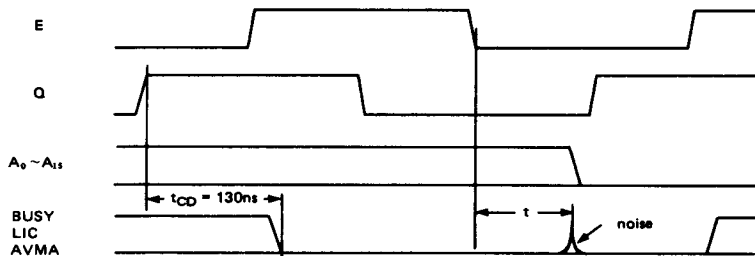

Noise peak (worst case); about 1.5V

Test condition

T_a = -20°C

V_{CC} = 5.5V

Number of address bus lines switching from "High" to "Low" =

16 (\$FFFF→\$0000) address bus load capacitance = 90pF

Period of the noise occurrence (reference data)

t = 25~65ns (T_a = -20°C)

t = 30~74ns (T_a = 25°C)

t = 34~83ns (T_a = 75°C)

Figure 22 Noise at address bus output changing



Countermeasure: To prevent the noise on BUSY, LIC, AVMA outputs from appearing, this signals must be latched at the negative edge of E or Q clock as

shown in Figure 23. An example of countermeasure circuit is shown in Figure 24.

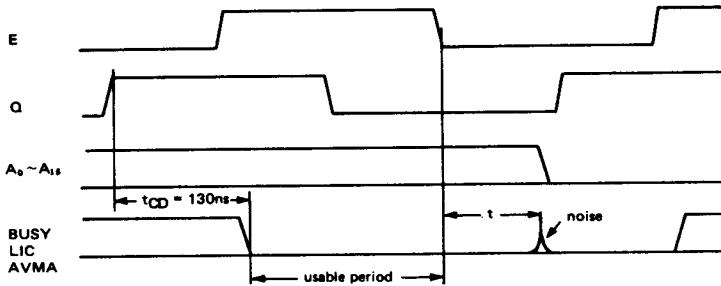

Figure 23 An example of countermeasure of the noise

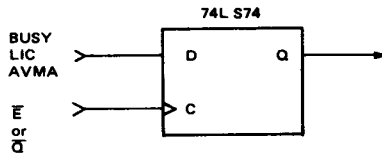

Figure 24 An example of countermeasure circuit

