

September 1995

Features

- 3 Micron Radiation Hardened CMOS SOS
- Total Dose 200K RAD (Si)
- Minimum LET for SEU Upsets: >100 MEV-cm²/mg
- Single Event Upset (SEU) Immunity < 2 x 10⁻⁹ Errors/Bit-Day (Typ)
- Dose Rate Survivability: >1 x 10¹² RAD (Si)/s
- Dose Rate Upset >10¹⁰ RAD (Si)/s 20ns Pulse
- Latch-Up Free Under Any Conditions
- Military Temperature Range: -55°C to +125°C
- Significant Power Reduction Compared to LSTTL ICs
- DC Operating Voltage Range: 4.5V to 5.5V
- Input Logic Levels
 - VIL = 0.8V Max
 - VIH = VCC/2V Min
- Input Current Levels I_i ≤ 5μA at VOL, VOH

Description

The Intersil HCTS161AMS high-reliability high-speed presettable four-bit binary synchronous counter features asynchronous reset and look-ahead carry logic. The HCTS161AMS has an active-low master reset to zero, MR. A low level at the synchronous parallel enable, SPE, disables counting and allows data at the preset inputs (P0 - P3) to load the counter. The data is latched to the outputs on the positive edge of the clock input, CP. The HCTS161AMS has two count enable pins, PE and TE. TE also controls the terminal count output, TC. The terminal count output indicates a maximum count for one clock pulse and is used to enable the next cascaded stage to count.

The HCTS161AMS utilizes advanced CMOS/SOS technology to achieve high-speed operation. This device is a member of radiation hardened, high-speed, CMOS/SOS Logic Family.

The HCTS161AMS is supplied in a 16 lead Ceramic flatpack (K suffix) or a SBDIP Package (D suffix).

Pinouts

16 LEAD CERAMIC DUAL-IN-LINE METAL SEAL PACKAGE (SBDIP)
MIL-STD-1835 CDIP2-T16, LEAD FINISH C
TOP VIEW

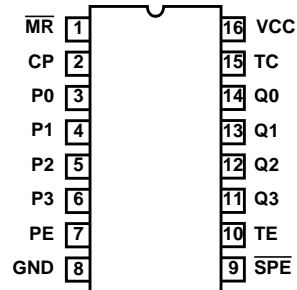

16 LEAD CERAMIC METAL SEAL FLATPACK PACKAGE (FLATPACK)
MIL-STD-1835 CDFP4-F16, LEAD FINISH C
TOP VIEW

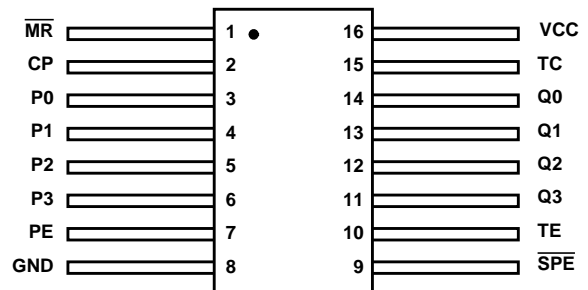

Ordering Information

PART NUMBER	TEMPERATURE RANGE	SCREENING LEVEL	PACKAGE
HCTS161ADMSR	-55°C to +125°C	Intersil Class S Equivalent	16 Lead SBDIP
HCTS161AKMSR	-55°C to +125°C	Intersil Class S Equivalent	16 Lead Ceramic Flatpack
HCTS161AD/Sample	+25°C	Sample	16 Lead SBDIP
HCTS161AK/Sample	+25°C	Sample	16 Lead Ceramic Flatpack
HCTS161AHMSR	+25°C	Die	Die

Specifications HCTS161AMS

Absolute Maximum Ratings

Supply Voltage (VCC)	-0.5 to +7.0V
Input Voltage Range, All Inputs	-0.5V to VCC +0.5V
DC Input Current, Any One Input	±10mA
DC Drain Current, Any One Output (All Voltage Reference to the VSS Terminal)	±25mA
Storage Temperature Range (TSTG)	-65°C to +150°C
Lead Temperature (Soldering 10sec)	+265°C
Junction Temperature (TJ)	+175°C
ESD Classification	Class 1

Reliability Information

Thermal Resistance	θ_{JA}	θ_{JC}
SBDIP Package	73°C/W	24°C/W
Ceramic Flatpack Package	114°C/W	29°C/W
Maximum Package Power Dissipation at +125°C Ambient		
SBDIP Package	0.68W	
Ceramic Flatpack Package	0.44W	
If device power exceeds package dissipation capability, provide heat sinking or derate linearly at the following rate:		
SBDIP Package	13.7mW/°C	
Ceramic Flatpack Package	8.8mW/°C	

CAUTION: As with all semiconductors, stress listed under "Absolute Maximum Ratings" may be applied to devices (one at a time) without resulting in permanent damage. This is a stress rating only. Exposure to absolute maximum rating conditions for extended periods may affect device reliability. The conditions listed under "Electrical Performance Characteristics" are the only conditions recommended for satisfactory device operation.

Operating Conditions

Supply Voltage (VCC)	+4.5V to +5.5V	Input Low Voltage (VIL)	0.0V to 0.8V
Input Rise and Fall Times at VCC = 4.5V (TR, TF)	100ns Max	Input High Voltage (VIH)	VCC/2 to VCC
Operating Temperature Range (TA)	-55°C to +125°C		

TABLE 1. DC ELECTRICAL PERFORMANCE CHARACTERISTICS

PARAMETER	SYMBOL	(NOTE 1) CONDITIONS	GROUP A SUB- GROUPS	TEMPERATURE	LIMITS		UNITS
					MIN	MAX	
Supply Current	ICC	VCC = 5.5V, VIN = VCC or GND	1	+25°C	-	40	μA
			2, 3	+125°C, -55°C	-	750	μA
Output Current (Sink)	IOL	VCC = 4.5V, VIH = 4.5V, VOUT = 0.4V, VIL = 0V, (Note 2)	1	+25°C	4.8	-	mA
			2, 3	+125°C, -55°C	4.0	-	mA
Output Current (Source)	IOH	VCC = 4.5V, VIH = 4.5V, VOUT = VCC -0.4V, VIL = 0V, (Note 2)	1	+25°C	-4.8	-	mA
			2, 3	+125°C, -55°C	-4.0	-	mA
Output Voltage Low	VOL	VCC = 4.5V, VIH = 2.25V, IOL = 50μA, VIL = 0.8V	1, 2, 3	+25°C, +125°C, -55°C	-	0.1	V
		VCC = 5.5V, VIH = 2.75V, IOL = 50μA, VIL = 0.8V	1, 2, 3	+25°C, +125°C, -55°C	-	0.1	V
Output Voltage High	VOH	VCC = 4.5V, VIH = 2.25V, IOH = -50μA, VIL = 0.8V	1, 2, 3	+25°C, +125°C, -55°C	VCC -0.1	-	V
		VCC = 5.5V, VIH = 2.75V, IOH = -50μA, VIL = 0.8V	1, 2, 3	+25°C, +125°C, -55°C	VCC -0.1	-	V
Input Leakage Current	IIN	VCC = 5.5V, VIN = VCC or GND	1	+25°C	-	±0.5	μA
			2, 3	+125°C, -55°C	-	±5.0	μA
Noise Immunity Functional Test	FN	VCC = 4.5V, VIH = 2.25V, VIL = 0.8V, (Note 3)	7, 8A, 8B	+25°C, +125°C, -55°C	-	-	V

NOTES:

1. All voltages reference to device GND.
2. Force/measure functions may be interchanged.
3. For functional tests VO ≥ 4.0V is recognized as a logic "1", and VO ≤ 0.5V is recognized as a logic "0".

Specifications HCTS161AMS

TABLE 2. AC ELECTRICAL PERFORMANCE CHARACTERISTICS

PARAMETER	SYMBOL	(NOTES 1, 2) CONDITIONS	GROUP A SUB- GROUPS	TEMPERATURE	LIMITS		UNITS
					MIN	MAX	
Propagation Delay CP to Qn	TPLH1	VCC = 4.5V, VIH = 3.0V, VIL = 0V	9	+25°C	2	27	ns
			10, 11	+125°C, -55°C	2	29	ns
	TPHL1	VCC = 4.5V, VIH = 3.0V, VIL = 0V	9	+25°C	2	27	ns
			10, 11	+125°C, -55°C	2	29	ns
Propagation Delay CP to TC	TPLH2	VCC = 4.5V, VIH = 3.0V, VIL = 0V	9	+25°C	2	28	ns
			10, 11	+125°C, -55°C	2	31	ns
	TPHL2	VCC = 4.5V, VIH = 3.0V, VIL = 0V	9	+25°C	2	29	ns
			10, 11	+125°C, -55°C	2	33	ns
Propagation Delay TE to TC	TPLH3	VCC = 4.5V, VIH = 3.0V, VIL = 0V	9	+25°C	2	20	ns
			10, 11	+125°C, -55°C	2	21	ns
	TPHL3	VCC = 4.5V, VIH = 3.0V, VIL = 0V	9	+25°C	2	25	
			10, 11	+125°C, -55°C	2	29	
Propagation Delay MR to Q	TPHL4	VCC = 4.5V, VIH = 3.0V, VIL = 0V	9	+25°C	2	38	ns
			10, 11	+125°C, -55°C	2	45	ns
Propagation Delay MR to TC	TPHL5	VCC = 4.5V, VIH = 3.0V, VIL = 0V	9	+25°C	2	44	ns
			10, 11	+125°C, -55°C	2	51	ns

NOTES:

1. All voltages referenced to device GND.
2. AC measurements assume RL = 500Ω, CL = 50pF, Input TR = TF = 3ns, VIL = GND, VIH = VCC.

TABLE 3. ELECTRICAL PERFORMANCE CHARACTERISTICS

PARAMETER	SYMBOL	(NOTE 1) CONDITIONS	TEMPERATURE	LIMITS		UNITS
				MIN	MAX	
Capacitance Power Dissipation	CPD	VCC = 5.0V, VIH = 5.0, VIL = 0.0V, f = 1MHz	+25°C	-	231	pF
			+125°C, -55°C	-	285	pF
Input Capacitance	CIN	VCC = 5.0V, VIH = 5.0, VIL = 0.0V, f = 1MHz	+25°C	-	10	pF
			+125°C, -55°C	-	10	pF
Pulse Width Time CP	TW	VCC = 4.5V, VIH = 4.5, VIL = 0.0V,	+25°C	16	-	ns
			+125°C, -55°C	24	-	ns
Pulse Width Time MR	TW	VCC = 4.5V, VIH = 4.5, VIL = 0.0V,	+25°C	20	-	ns
			+125°C, -55°C	30	-	ns
Setup Time Pn to CP	TSU	VCC = 4.5V, VIH = 4.5, VIL = 0.0V,	+25°C	10	-	ns
			+125°C, -55°C	15	-	ns
Setup Time PE to CP or TE	TSU	VCC = 4.5V, VIH = 4.5, VIL = 0.0V,	+25°C	13	-	ns
			+125°C, -55°C	20	-	ns
Setup Time SPE to CP	TSU	VCC = 4.5V, VIH = 4.5, VIL = 0.0V,	+25°C	12	-	ns
			+125°C, -55°C	18	-	ns
Hold Time Pn to CP	TSU	VCC = 4.5V, VIH = 4.5, VIL = 0.0V,	+25°C	5	-	ns
			+125°C, -55°C	5	-	ns

Specifications HCTS161AMS

TABLE 3. ELECTRICAL PERFORMANCE CHARACTERISTICS (Continued)

PARAMETER	SYMBOL	(NOTE 1) CONDITIONS	TEMPERATURE	LIMITS		UNITS
				MIN	MAX	
Hold Time TE or PE to CP	TSU	VCC = 4.5V, VIH = 4.5, VIL = 0.0V,	+25°C	3	-	ns
			+125°C, -55°C	3	-	ns
Hold Time SPE to CP	TSU	VCC = 4.5V, VIH = 4.5, VIL = 0.0V,	+25°C	3	-	ns
			+125°C, -55°C	3	-	ns
Recovery Time	TREC	VCC = 4.5V, VIH = 4.5, VIL = 0.0V,	+25°C	15	-	ns
			+125°C, -55°C	22	-	ns
Maximum Frequency	FMAX	VCC = 4.5V, VIH = 4.5, VIL = 0.0V,	+25°C	0	30	MHz
			+125°C, -55°C	0	20	MHz

NOTE:

- The parameters listed in Table 3 are controlled via design or process parameters. Min and Max Limits are guaranteed but not directly tested. These parameters are characterized upon initial design release and upon design changes which affect these characteristics.

TABLE 4. DC POST RADIATION ELECTRICAL PERFORMANCE CHARACTERISTICS

PARAMETER	SYMBOL	(NOTES 1, 2) CONDITIONS	TEMPERATURE	200K RAD LIMITS		UNITS
				MIN	MAX	
Supply Current	ICC	VCC = 5.5V, VIN = VCC or GND	+25°C	-	0.75	mA
Output Current (Sink)	IOL	VCC = 4.5V, VIH = 4.5, VIL = 0V, VOU = 0.4V	+25°C	4.0	-	mA
Output Current (Source)	IOH	VCC = 4.5V, VIH = 4.5, VIL = 0V, VOU = VCC - 0.4V	+25°C	-4.0	-	mA
Output Voltage Low	VOL	VCC = 4.5V, VIH = 2.25V, VIL = 0.8V , IOL = 50µA	+25°C	-	0.1	V
		VCC = 5.5V, VIH = 2.75V, VIL = 0.8V , IOL = 50µA	+25°C	-	0.1	V
Output Voltage High	VOH	VCC = 4.5V, VIH = 2.25V, VIL = 0.8V, IOH = -50µA	+25°C	VCC -0.1	-	V
		VCC = 5.5V, VIH = 2.75V, VIL = 0.8V, IOH = -50µA	+25°C	VCC -0.1	-	V
Input Leakage Current	IIN	VCC = 5.5V, VIN = VCC or GND	+25°C	-	±5	µA
Noise Immunity Functional Test	FN	VCC = 4.5V, VIH = 2.25V, VIL = 0.8V , (Note 2)	+25°C	-	-	V
Propagation Delay CP to Qn	TPHL1	VCC = 4.5V, VIH = 3.0V, VIL = 0V	+25°C	2	29	ns
	TPLH1	VCC = 4.5V, VIH = 3.0V, VIL = 0V	+25°C	2	29	ns
Propagation Delay CP to TC	TPHL2	VCC = 4.5V, VIH = 3.0V, VIL = 0V	+25°C	2	33	ns
	TPLH2	VCC = 4.5V, VIH = 3.0V, VIL = 0V	+25°C	2	31	ns
Propagation Delay TE to TC	TPHL3	VCC = 4.5V, VIH = 3.0V, VIL = 0V	+25°C	2	29	ns
	TPLH3	VCC = 4.5V, VIH = 3.0V, VIL = 0V	+25°C	2	21	ns
Propagation Delay MR to Q	TPHL4	VCC = 4.5V, VIH = 3.0V, VIL = 0V	+25°C	2	45	ns
Propagation Delay MR to TC	TPHL5	VCC = 4.5V, VIH = 3.0V, VIL = 0V	+25°C	2	51	ns

NOTES:

- All voltages referenced to device GND.
- For functional tests $VO \geq 4.0V$ is recognized as a logic "1", and $VO \leq 0.5V$ is recognized as a logic "0".

Specifications HCTS161AMS

TABLE 5. BURN-IN AND OPERATING LIFE TEST, DELTA PARAMETERS (+25°C)

PARAMETER	GROUP B SUBGROUP	DELTA LIMIT
ICC	5	12μA
IOL/IOH	5	-15% of 0 Hour

TABLE 6. APPLICABLE SUBGROUPS

CONFORMANCE GROUPS	METHOD	GROUP A SUBGROUPS	READ AND RECORD	
Initial Test (Preburn-In)	100%/5004	1, 7, 9	ICC, IOL/H	
Interim Test I (Postburn-In)	100%/5004	1, 7, 9	ICC, IOL/H	
Interim Test II (Postburn-In)	100%/5004	1, 7, 9	ICC, IOL/H	
PDA	100%/5004	1, 7, 9, Deltas		
Interim Test III (Postburn-In)	100%/5004	1, 7, 9	ICC, IOL/H	
PDA	100%/5004	1, 7, 9, Deltas		
Final Test	100%/5004	2, 3, 8A, 8B, 10, 11		
Group A (Note 1)	Sample/5005	1, 2, 3, 7, 8A, 8B, 9, 10, 11		
Group B	Subgroup B-5	Sample/5005	1, 2, 3, 7, 8A, 8B, 9, 10, 11, Deltas	Subgroups 1, 2, 3, 9, 10, 11
	Subgroup B-6	Sample/5005	1, 7, 9	
Group D	Sample/5005	1, 7, 9		

NOTE:

1. Alternate group A testing in accordance with method 5005 of MIL-STD-883 may be exercised.

TABLE 7. TOTAL DOSE IRRADIATION

CONFORMANCE GROUPS	METHOD	TEST		READ AND RECORD	
		PRE RAD	POST RAD	PRE RAD	POST RAD
Group E Subgroup 2	5005	1, 7, 9	Table 4	1, 9	Table 4 (Note 1)

NOTE:

1. Except FN test which will be performed 100% Go/No-Go.

HCTS161AMS

TABLE 8. STATIC AND DYNAMIC BURN-IN TEST CONNECTIONS

OPEN	GROUND	1/2 VCC = 3V ± 0.5V	VCC = 6V ± 0.5V	OSCILLATOR	
				50kHz	25kHz
STATIC BURN-IN I TEST CONNECTIONS (Note 1)					
11 - 15	1 - 10	-	16	-	-
STATIC BURN-IN II TEST CONNECTIONS (Note 1)					
11 - 15	8	-	1 - 7, 9, 10, 16	-	-
DYNAMIC BURN-IN TEST CONNECTIONS (Note 2)					
-	4, 6, 8	11 - 15	1, 3, 5, 7, 9, 10, 16	2	-

NOTES:

1. Each pin except VCC and GND will have a resistor of 10kΩ ± 5% for static burn-in
2. Each pin except VCC and GND will have a resistor of 1kΩ ± 5% for dynamic burn-in

TABLE 9. IRRADIATION TEST CONNECTIONS

OPEN	GROUND	VCC = 5V ± 0.5V
11 - 15	8	1 - 7, 9, 10, 16

NOTE: Each pin except VCC and GND will have a resistor of 47KΩ ± 5% for irradiation testing.
Group E, Subgroup 2, sample size is 4 dice/wafer 0 failures.

HCTS161AMS

Intersil Space Level Product Flow - 'MS'

Wafer Lot Acceptance (All Lots) Method 5007 (Includes SEM)	100% Interim Electrical Test 1 (T1)
GAMMA Radiation Verification (Each Wafer) Method 1019, 4 Samples/Wafer, 0 Rejects	100% Delta Calculation (T0-T1)
100% Nondestructive Bond Pull, Method 2023	100% Static Burn-In 2, Condition A or B, 24 hrs. min., +125°C min., Method 1015
Sample - Wire Bond Pull Monitor, Method 2011	100% Interim Electrical Test 2 (T2)
Sample - Die Shear Monitor, Method 2019 or 2027	100% Delta Calculation (T0-T2)
100% Internal Visual Inspection, Method 2010, Condition A	100% PDA 1, Method 5004 (Notes 1 and 2)
100% Temperature Cycle, Method 1010, Condition C, 10 Cycles	100% Dynamic Burn-In, Condition D, 240 hrs., +125°C or Equivalent, Method 1015
100% Constant Acceleration, Method 2001, Condition per Method 5004	100% Interim Electrical Test 3 (T3)
100% PIND, Method 2020, Condition A	100% Delta Calculation (T0-T3)
100% External Visual	100% PDA 2, Method 5004 (Note 2)
100% Serialization	100% Final Electrical Test
100% Initial Electrical Test (T0)	100% Fine/Gross Leak, Method 1014
100% Static Burn-In 1, Condition A or B, 24 hrs. min., +125°C min., Method 1015	100% Radiographic, Method 2012 (Note 3)
	100% External Visual, Method 2009
	Sample - Group A, Method 5005 (Note 4)
	100% Data Package Generation (Note 5)

NOTES:

1. Failures from Interim electrical test 1 and 2 are combined for determining PDA 1.
2. Failures from subgroup 1, 7, 9 and deltas are used for calculating PDA. The maximum allowable PDA = 5% with no more than 3% of the failures from subgroup 7.
3. Radiographic (X-Ray) inspection may be performed at any point after serialization as allowed by Method 5004.
4. Alternate Group A testing may be performed as allowed by MIL-STD-883, Method 5005.
5. Data Package Contents:
 - Cover Sheet (Intersil Name and/or Logo, P.O. Number, Customer Part Number, Lot Date Code, Intersil Part Number, Lot Number, Quantity).
 - Wafer Lot Acceptance Report (Method 5007). Includes reproductions of SEM photos with percent of step coverage.
 - GAMMA Radiation Report. Contains Cover page, disposition, Rad Dose, Lot Number, Test Package used, Specification Numbers, Test equipment, etc. Radiation Read and Record data on file at Intersil.
 - X-Ray report and film. Includes penetrometer measurements.
 - Screening, Electrical, and Group A attributes (Screening attributes begin after package seal).
 - Lot Serial Number Sheet (Good units serial number and lot number).
 - Variables Data (All Delta operations). Data is identified by serial number. Data header includes lot number and date of test.
 - The Certificate of Conformance is a part of the shipping invoice and is not part of the Data Book. The Certificate of Conformance is signed by an authorized Quality Representative.

All Intersil semiconductor products are manufactured, assembled and tested under **ISO9000** quality systems certification.

Intersil products are sold by description only. Intersil Corporation reserves the right to make changes in circuit design and/or specifications at any time without notice. Accordingly, the reader is cautioned to verify that data sheets are current before placing orders. Information furnished by Intersil is believed to be accurate and reliable. However, no responsibility is assumed by Intersil or its subsidiaries for its use; nor for any infringements of patents or other rights of third parties which may result from its use. No license is granted by implication or otherwise under any patent or patent rights of Intersil or its subsidiaries.

For information regarding Intersil Corporation and its products, see web site <http://www.intersil.com>

Sales Office Headquarters

NORTH AMERICA

Intersil Corporation
P. O. Box 883, Mail Stop 53-204
Melbourne, FL 32902
TEL: (321) 724-7000
FAX: (321) 724-7240

EUROPE

Intersil SA
Mercure Center
100, Rue de la Fusee
1130 Brussels, Belgium
TEL: (32) 2.724.2111
FAX: (32) 2.724.22.05

ASIA

Intersil (Taiwan) Ltd.
Taiwan Limited
7F-6, No. 101 Fu Hsing North Road
Taipei, Taiwan
Republic of China
TEL: (886) 2 2716 9310
FAX: (886) 2 2715 3029

Propagation Delay Timing Diagram

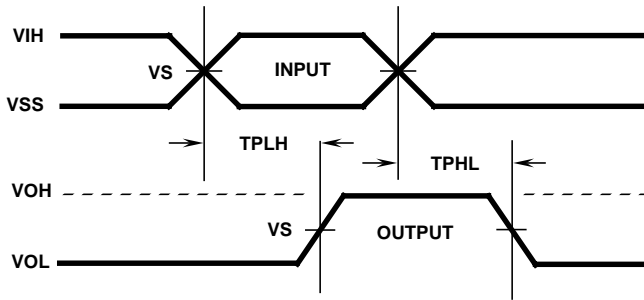

AC VOLTAGE LEVELS

PARAMETER	HCTS	UNITS
VCC	4.50	V
VIH	3.00	V
VS	1.30	V
VIL	0	V
GND	0	V

Propagation Delay Load Circuit

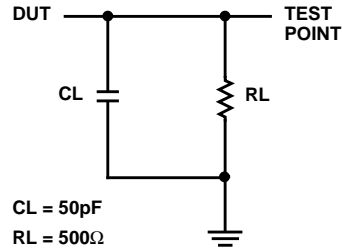

Pulse Width, Setup, Hold Timing Diagram Positive Edge Trigger

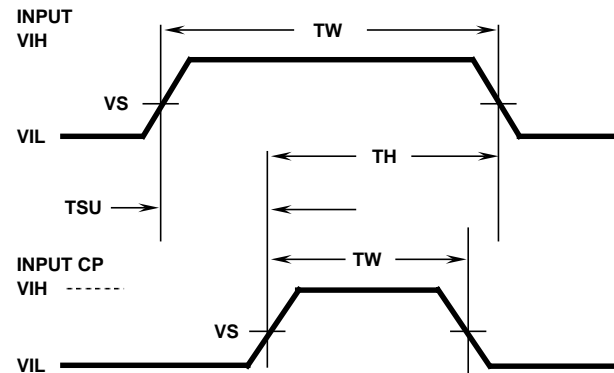

TH = HOLD TIME
 TSU = SETUP TIME
 TW = PULSE WIDTH

VOLTAGE LEVELS

PARAMETER	HCTS	UNITS
VCC	4.50	V
VIH	3.00	V
VS	1.30	V
VIL	0	V
GND	0	V

AC Load Circuit

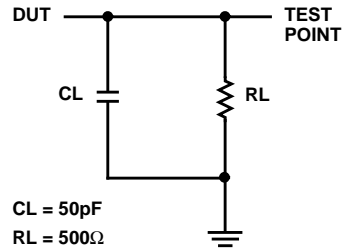

HCTS161AMS

Die Characteristics

DIE DIMENSIONS:

86 x 104mils
2.19 x 2.65mm

METALLIZATION:

Type: AlSi
Metal Thickness: $11\text{k}\text{\AA} \pm 1\text{k}\text{\AA}$

GLASSIVATION:

Type: SiO_2
Thickness: $13\text{k}\text{\AA} \pm 2.6\text{k}\text{\AA}$

WORST CASE CURRENT DENSITY:

$<2.0 \times 10^5 \text{A/cm}^2$

BOND PAD SIZE:

$100\mu\text{m} \times 100\mu\text{m}$
4 x 4 mils

Metallization Mask Layout

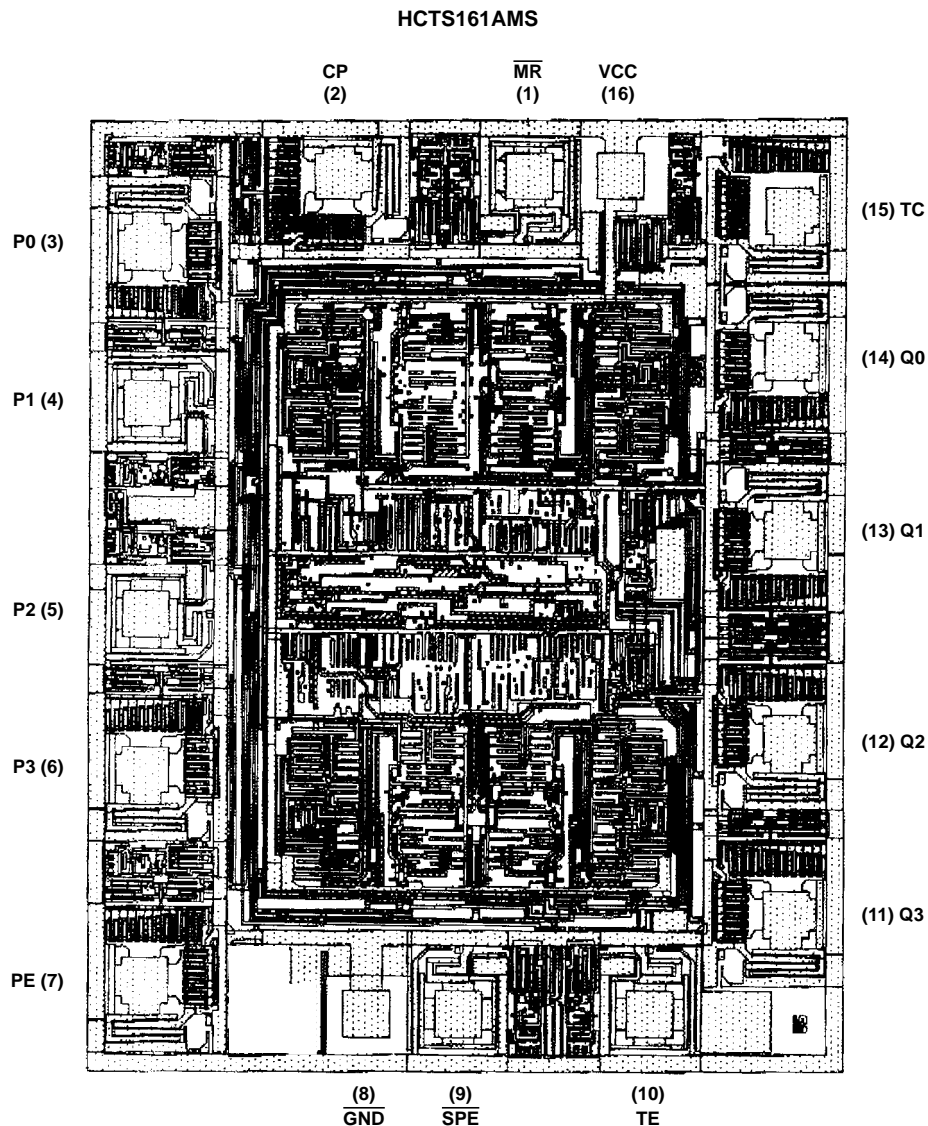

NOTE: The die diagram is a generic plot form a similar HCS device. It is intended to indicate approximate die size and bond pad location. The mask series for the HCTS161A is TA14446A.