

To all our customers

Regarding the change of names mentioned in the document, such as Hitachi Electric and Hitachi XX, to Renesas Technology Corp.

The semiconductor operations of Mitsubishi Electric and Hitachi were transferred to Renesas Technology Corporation on April 1st 2003. These operations include microcomputer, logic, analog and discrete devices, and memory chips other than DRAMs (flash memory, SRAMs etc.) Accordingly, although Hitachi, Hitachi, Ltd., Hitachi Semiconductors, and other Hitachi brand names are mentioned in the document, these names have in fact all been changed to Renesas Technology Corp. Thank you for your understanding. Except for our corporate trademark, logo and corporate statement, no changes whatsoever have been made to the contents of the document, and these changes do not constitute any alteration to the contents of the document itself.

Renesas Technology Home Page: <http://www.renesas.com>

Renesas Technology Corp.
Customer Support Dept.
April 1, 2003

Cautions

Keep safety first in your circuit designs!

1. Renesas Technology Corporation puts the maximum effort into making semiconductor products better and more reliable, but there is always the possibility that trouble may occur with them. Trouble with semiconductors may lead to personal injury, fire or property damage.

Remember to give due consideration to safety when making your circuit designs, with appropriate measures such as (i) placement of substitutive, auxiliary circuits, (ii) use of nonflammable material or (iii) prevention against any malfunction or mishap.

Notes regarding these materials

1. These materials are intended as a reference to assist our customers in the selection of the Renesas Technology Corporation product best suited to the customer's application; they do not convey any license under any intellectual property rights, or any other rights, belonging to Renesas Technology Corporation or a third party.
2. Renesas Technology Corporation assumes no responsibility for any damage, or infringement of any third-party's rights, originating in the use of any product data, diagrams, charts, programs, algorithms, or circuit application examples contained in these materials.
3. All information contained in these materials, including product data, diagrams, charts, programs and algorithms represents information on products at the time of publication of these materials, and are subject to change by Renesas Technology Corporation without notice due to product improvements or other reasons. It is therefore recommended that customers contact Renesas Technology Corporation or an authorized Renesas Technology Corporation product distributor for the latest product information before purchasing a product listed herein.
The information described here may contain technical inaccuracies or typographical errors. Renesas Technology Corporation assumes no responsibility for any damage, liability, or other loss rising from these inaccuracies or errors.
Please also pay attention to information published by Renesas Technology Corporation by various means, including the Renesas Technology Corporation Semiconductor home page (<http://www.renesas.com>).
4. When using any or all of the information contained in these materials, including product data, diagrams, charts, programs, and algorithms, please be sure to evaluate all information as a total system before making a final decision on the applicability of the information and products. Renesas Technology Corporation assumes no responsibility for any damage, liability or other loss resulting from the information contained herein.
5. Renesas Technology Corporation semiconductors are not designed or manufactured for use in a device or system that is used under circumstances in which human life is potentially at stake. Please contact Renesas Technology Corporation or an authorized Renesas Technology Corporation product distributor when considering the use of a product contained herein for any specific purposes, such as apparatus or systems for transportation, vehicular, medical, aerospace, nuclear, or undersea repeater use.
6. The prior written approval of Renesas Technology Corporation is necessary to reprint or reproduce in whole or in part these materials.
7. If these products or technologies are subject to the Japanese export control restrictions, they must be exported under a license from the Japanese government and cannot be imported into a country other than the approved destination.
Any diversion or reexport contrary to the export control laws and regulations of Japan and/or the country of destination is prohibited.
8. Please contact Renesas Technology Corporation for further details on these materials or the products contained therein.

HA17431 Series

Shunt Regulator

RENESAS

ADE-204-049A (Z)

Rev.1
Sep. 2002

Description

The HA17431 series is temperature-compensated variable shunt regulators. The main application of these products is in voltage regulators that provide a variable output voltage. The on-chip high-precision reference voltage source can provide $\pm 1\%$ accuracy in the V versions, which have a V_{KA} max of 16 volts. The HA17431VLP, which is provided in the MPAK-5 package, is designed for use in switching mode power supplies. It provides a built-in photocoupler bypass resistor for the PS pin, and an error amplifier can be easily constructed on the supply side.

Features

- The V versions provide $2.500\text{ V} \pm 1\%$ at $T_a = 25^\circ\text{C}$
- The HA17431VLP includes a photocoupler bypass resistor ($2\text{ k}\Omega$)
- The reference voltage has a low temperature coefficient
- The MPAK-5(5-pin), MPAK(3-pin) and UPAK miniature packages are optimal for use on high mounting density circuit boards
- Car use is provided

Block Diagram

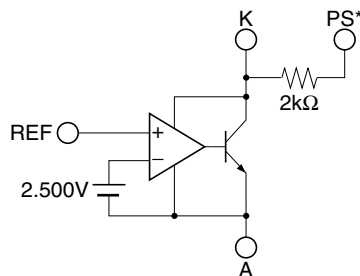

Note: * The PS pin is only provided by the HA17431VLP.

Application Circuit Example

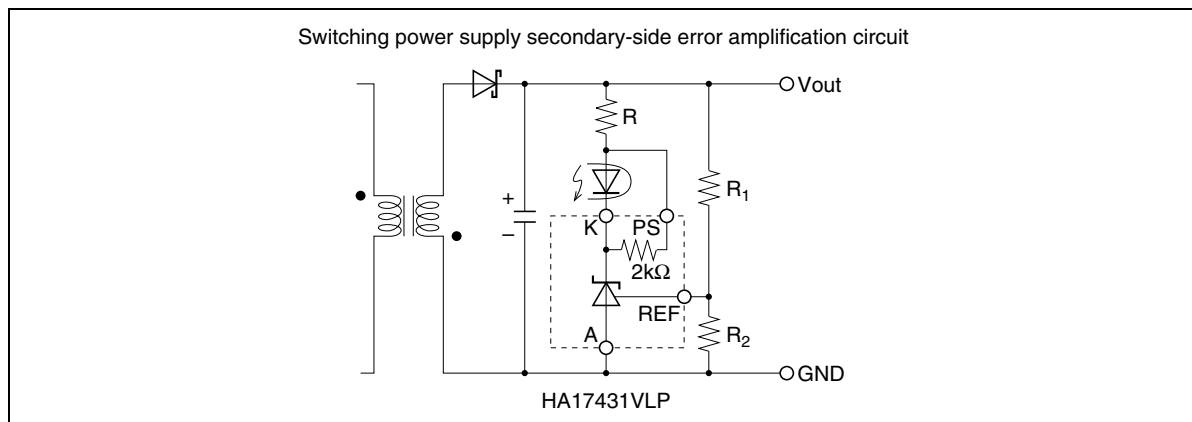

Ordering Information

Item		Version			Package	Operating Temperature Range
		V Version	A Version	Normal Version		
Reference voltage (at 25°C)	Accuracy	±1%	±2.2%	±4%		
	Max	2.525 V	2.550 V	2.595 V		
	Typ	2.500 V	2.495 V	2.495 V		
	Min	2.475 V	2.440 V	2.395 V		
Cathode voltage		16 V max	40 V max	40 V max		
Cathode current		50 mA max	150 mA max	150 mA max		
Car use		HA17431VPJ			TO-92	-40 to +85°C
		HA17431PNAJ				
		HA17431PAJ			TO-92MOD	
		HA17431PJ				
		HA17431FPAJ			FP-8D	
		HA17431FPJ				

Ordering Information (cont.)

Item	Version			Package	Operating Temperature Range
	V Version	A Version	Normal Version		
Industrial use	HA17431VLTP			MPAK	-20 to +85°C
	HA17432VLTP				
	HA17431VLP			MPAK-5	
	HA17431VP			TO-92	
		HA17431PNA			
	HA17431VUP			UPAK	
		HA17431UPA			
	HA17432VUP				
		HA17432UPA			
		HA17431PA		TO-92MOD	
			HA17431P		
	HA17431FPA		FP-8D		
		HA17431FP			
Commercial use		HA17431UA		UPAK	
		HA17432UA			

Pin Arrangement

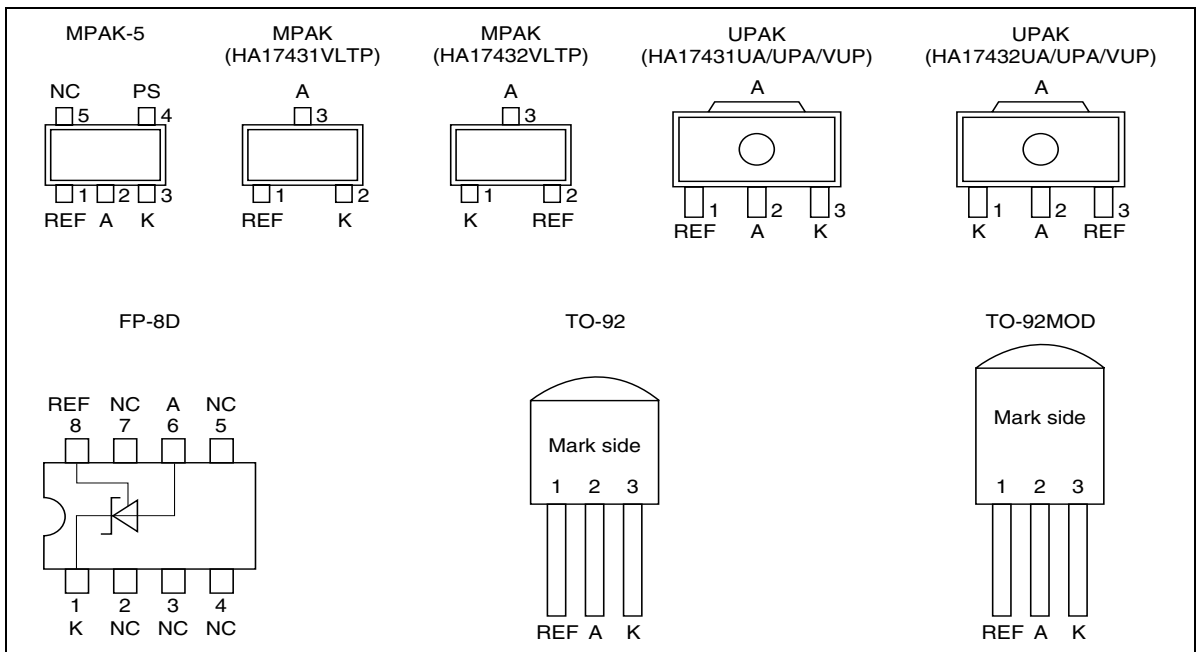

HA17431 Series

Absolute Maximum Ratings

(Ta = 25°C)

Item	Symbol	HA17431VLP	HA17431VP	HA17431VPJ	Unit	Notes
Cathode voltage	V _{KA}	16	16	16	V	1
PS term. voltage	V _{PS}	V _{KA} to 16	—	—	V	1,2,3
Continuous cathode current	I _K	-50 to +50	-50 to +50	-50 to +50	mA	
Reference input current	I _{ref}	-0.05 to +10	-0.05 to +10	-0.05 to +10	mA	
Power dissipation	P _T	150 *4	500 *5	500 *5	mW	4, 5
Operating temperature range	Topr	-20 to +85	-20 to +85	-40 to +85	°C	
Storage temperature	Tstg	-55 to +150	-55 to +150	-55 to +150	°C	

Item	Symbol	HA17431VUP/HA17432VUP	HA17431VLTP/HA17432VLTP	Unit	Notes
Cathode voltage	V _{KA}	16	16	V	1
PS term. voltage	V _{PS}	—	—	V	1,2,3
Continuous cathode current	I _K	-50 to +50	-50 to +50	mA	
Reference input current	I _{ref}	-0.05 to +10	-0.05 to +10	mA	
Power dissipation	P _T	800 *8	150 *4	mW	4, 8
Operating temperature range	Topr	-20 to +85	-20 to +85	°C	
Storage temperature	Tstg	-55 to +150	-55 to +150	°C	

Item	Symbol	HA17431PNA	HA17431P/PA	HA17431FP/FPA	HA17431UA/UPA/ HA17432UA/UPA	Unit	Notes
Cathode voltage	V _{KA}	40	40	40	40	V	1
Continuous cathode current	I _K	-100 to +150	-100 to +150	-100 to +150	-100 to +150	mA	
Reference input current	I _{ref}	-0.05 to +10	-0.05 to +10	-0.05 to +10	-0.05 to +10	mA	
Power dissipation	P _T	500 *5	800 *6	500 *7	800 *8	mW	5,6,7,8
Operating temperature range	Topr	-20 to +85	-20 to +85	-20 to +85	-20 to +85	°C	
Storage temperature	Tstg	-55 to +150	-55 to +150	-55 to +125	-55 to +150	°C	

Absolute Maximum Ratings (cont.)

(Ta = 25°C)

Item	Symbol	HA17431PNAJ	HA17431PJ/PAJ	HA17431FPJ/FPAJ	Unit	Notes
Cathode voltage	V_{KA}	40	40	40	V	1
Continuous cathode current	I_K	-100 to +150	-100 to +150	-100 to +150	mA	
Reference input current	I_{ref}	-0.05 to +10	-0.05 to +10	-0.05 to +10	mA	
Power dissipation	P_T	500 ^{*5}	800 ^{*6}	500 ^{*7}	mW	5,6,7
Operating temperature range	T_{opr}	-40 to +85	-40 to +85	-40 to +85	°C	
Storage temperature	T_{stg}	-55 to +150	-55 to +150	-55 to +125	°C	

Notes: 1. Voltages are referenced to anode.

2. The PS pin is only provided by the HA17431VLP.

3. The PS pin voltage must not fall below the cathode voltage. If the PS pin is not used, the PS pin is recommended to be connected with the cathode.

4. $T_a \leq 25^\circ\text{C}$. If $T_a > 25^\circ\text{C}$, derate by 1.2 mW/°C.5. $T_a \leq 25^\circ\text{C}$. If $T_a > 25^\circ\text{C}$, derate by 4.0 mW/°C.6. $T_a \leq 25^\circ\text{C}$. If $T_a > 25^\circ\text{C}$, derate by 6.4 mW/°C.7. 50 mm × 50 mm × 1.5mm glass epoxy board(5% wiring density), $T_a \leq 25^\circ\text{C}$. If $T_a > 25^\circ\text{C}$, derate by 5 mW/°C.8. 15 mm × 25 mm × 0.7mm alumina ceramic board, $T_a \leq 25^\circ\text{C}$. If $T_a > 25^\circ\text{C}$, derate by 6.4 mW/°C.

HA17431 Series

Electrical Characteristics

HA17431VLP/VP/VPJ/VUP/VLTP, HA17432VUP/VLTP

($T_a = 25^\circ\text{C}$, $I_K = 10\text{ mA}$)

Item	Symbol	Min	Typ	Max	Unit	Test Conditions	Notes
Reference voltage	Vref	2.475	2.500	2.525	V	$V_{KA} = \text{Vref}$	
Reference voltage temperature deviation	Vref(dev)	—	10	—	mV	$V_{KA} = \text{Vref}$, $T_a = -20^\circ\text{C}$ to $+85^\circ\text{C}$	1
Reference voltage temperature coefficient	$\Delta\text{Vref}/\Delta T_a$	—	± 30	—	ppm/ $^\circ\text{C}$	$V_{KA} = \text{Vref}$, 0°C to 50°C gradient	
Reference voltage regulation	$\Delta\text{Vref}/\Delta V_{KA}$	—	2.0	3.7	mV/V	$V_{KA} = \text{Vref}$ to 16 V	
Reference input current	Iref	—	2	6	μA	$R_1 = 10\text{ k}\Omega$, $R_2 = \infty$	
Reference current temperature deviation	Iref(dev)	—	0.5	—	μA	$R_1 = 10\text{ k}\Omega$, $R_2 = \infty$, $T_a = -20^\circ\text{C}$ to $+85^\circ\text{C}$	
Minimum cathode current	Imin	—	0.4	1.0	mA	$V_{KA} = \text{Vref}$	2
Off state cathode current	Ioff	—	0.001	1.0	μA	$V_{KA} = 16\text{ V}$, $\text{Vref} = 0\text{ V}$	
Dynamic impedance	Z_{KA}	—	0.2	0.5	Ω	$V_{KA} = \text{Vref}$, $I_K = 1\text{ mA}$ to 50 mA	
Bypass resistance	R_{PS}	1.6	2.0	2.4	$\text{k}\Omega$	$I_{PS} = 1\text{ mA}$	3
Bypass resistance temperature coefficient	$\Delta R_{PS}/\Delta T_a$	—	+2000	—	ppm/ $^\circ\text{C}$	$I_{PS} = 1\text{ mA}$, 0°C to 50°C gradient	3

Electrical Characteristics (cont.)

HA17431PJ/PAJ/FPJ/FPAJ/P/PA/UA/UPA/FP/FPA/PNA/PNAJ, HA17432UA/UPA

($T_a = 25^\circ\text{C}$, $I_K = 10\text{ mA}$)

Item	Symbol	Min	Typ	Max	Unit	Test Conditions	Notes
Reference voltage	Vref	2.440	2.495	2.550	V	$V_{KA} = \text{Vref}$	A
		2.395	2.495	2.595			Normal
Reference voltage temperature deviation	Vref(dev)	—	11	(30)	mV	$V_{KA} = \text{Vref}$	$T_a = -20^\circ\text{C}$ to $+85^\circ\text{C}$
		—	5	(17)			$T_a = 0^\circ\text{C}$ to $+70^\circ\text{C}$
Reference voltage regulation	$\Delta\text{Vref}/\Delta V_{KA}$	—	1.4	3.7	mV/V	$V_{KA} = \text{Vref}$ to 10 V	
		—	1	2.2			$V_{KA} = 10\text{ V}$ to 40 V
Reference input current	Iref	—	3.8	6	μA	$R_1 = 10\text{ k}\Omega$, $R_2 = \infty$	
Reference current temperature deviation	Iref(dev)	—	0.5	(2.5)	μA	$R_1 = 10\text{ k}\Omega$, $R_2 = \infty$, $T_a = 0^\circ\text{C}$ to $+70^\circ\text{C}$	4
Minimum cathode current	Imin	—	0.4	1.0	mA	$V_{KA} = \text{Vref}$	2
Off state cathode current	Ioff	—	0.001	1.0	μA	$V_{KA} = 40\text{ V}$, $\text{Vref} = 0\text{ V}$	
Dynamic impedance	Z_{KA}	—	0.2	0.5	Ω	$V_{KA} = \text{Vref}$, $I_K = 1\text{ mA}$ to 100 mA	

Notes: 1. $\text{Vref(dev)} = \text{Vref(max)} - \text{Vref(min)}$

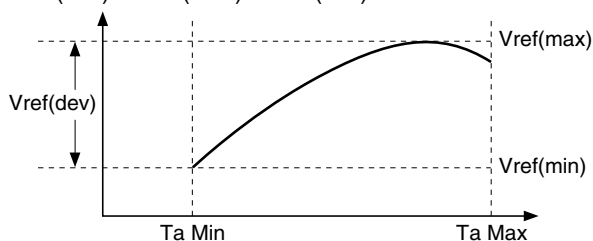

2. Imin is given by the cathode current at $\text{Vref} = \text{Vref}_{(I_K=10\text{mA})} - 15\text{ mV}$.
3. R_{PS} is only provided in HA17431VLP.
4. The maximum value is a design value (not measured).

MPAK-5(5-pin), MPAK(3-pin) and UPAK Marking Patterns

The marking patterns shown below are used on MPAK-5, MPAK and UPAK products. Note that the product code and mark pattern are different. The pattern is laser-printed.

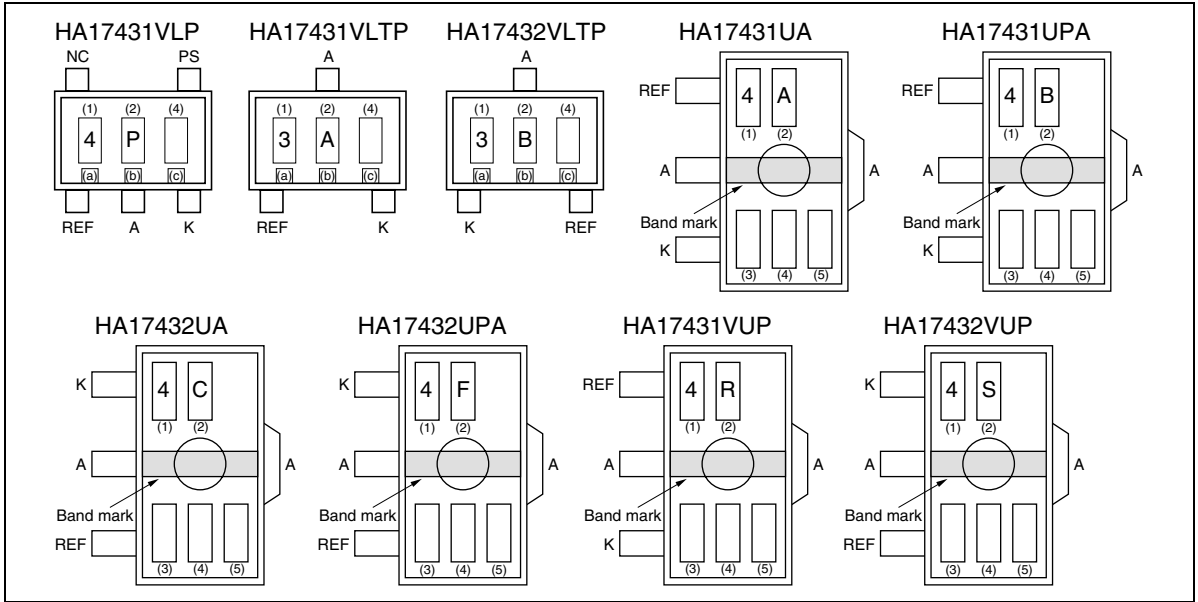

Notes: 1. Boxes (1) to (5) in the figures show the position of the letters or numerals, and are not actually marked on the package.

2. The letters (1) and (2) show the product specific mark pattern.

Product	(1)	(2)
HA17431VLP	4	P
HA17431VUP	4	R
HA17432VUP	4	S
HA17431VLTP	3	A
HA17432VLTP	3	B
HA17431UA	4	A
HA17431UPA	4	B
HA17432UA	4	C
HA17432UPA	4	F

3. The letter (3) shows the production year code (the last digit of the year) for UPAK products.

4. The bars (a), (b) and (c) show a production year code for MPAK-5 and MPAK products as shown below. After 2010 the code is repeated every 8 years.

Year	2002	2003	2004	2005	2006	2007	2008	2009
(a)	None	None	None	Bar	Bar	Bar	Bar	None
(b)	None	Bar	Bar	None	None	Bar	Bar	None
(c)	Bar	None	Bar	None	Bar	None	Bar	None

5. The letter (4) shows the production month code (see table below).

Production month	Jan.	Feb.	Mar.	Apr.	May.	Jun.	Jul.	Aug.	Sep.	Oct.	Nov.	Dec.
Marked code	A	B	C	D	E	F	G	H	J	K	L	M

6. The letter (5) shows manufacturing code. For UPAK products.

Characteristics Curves

HA17431VLP/VP/VPJ/VUP/VLTP, HA17432VUP/VLTP

Reference Voltage Temperature Characteristics

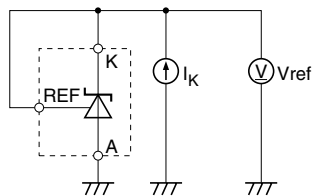
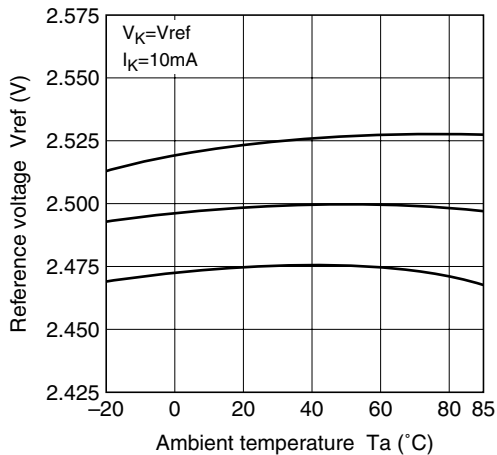

Cathode Current vs. Cathode Voltage Characteristics 1

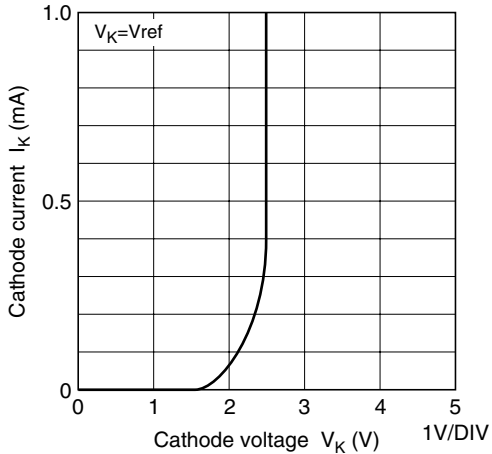

Cathode Current vs. Cathode Voltage Characteristics 2

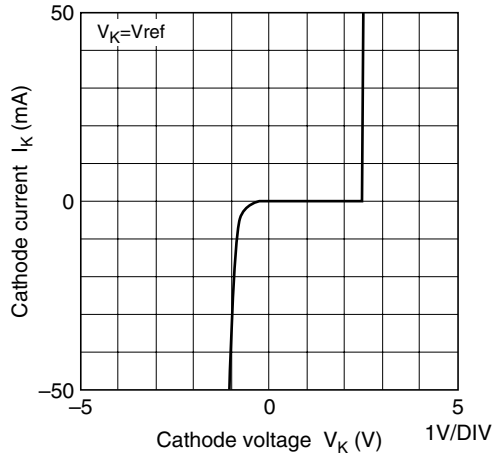

Dynamic Impedance vs. Frequency Characteristics

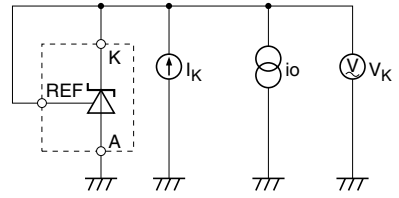
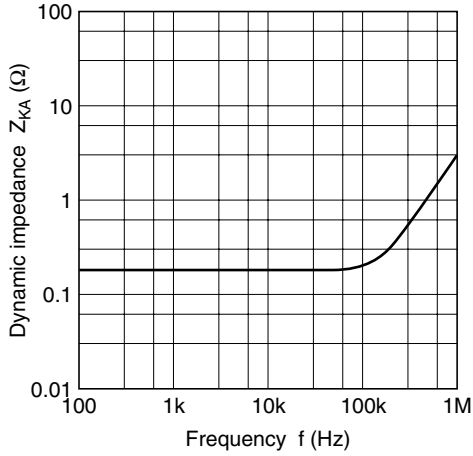

$$i_o = 2 \text{ mA}_{P-P}$$

$$Z_{KA} = \frac{V_K}{i_o} (\Omega)$$

Open Loop Voltage Gain, Phase vs. Frequency Characteristics

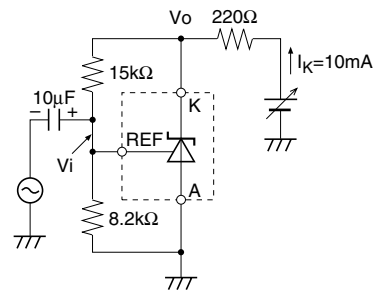
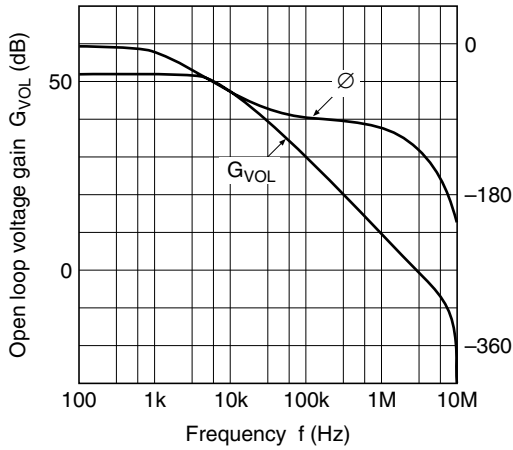

$$G = 20 \log \left(\frac{V_o}{V_i} \right) (\text{dB})$$

HA17431PJ/PAJ/FPJ/FPAJ/P/PA/UA/UPA/FP/FPA/PNA/PNAJ, HA17432UA/UPA

Oscillation Stability vs. Load Capacitance between Anode and Cathode

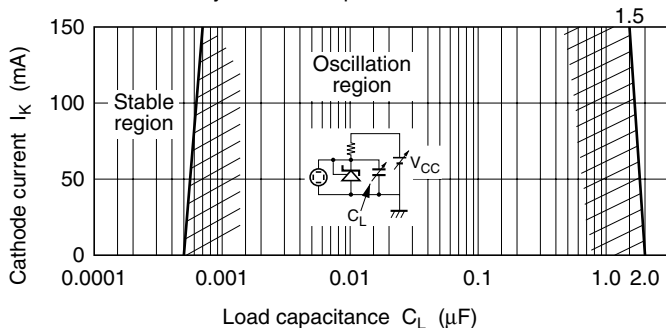

Open Loop Voltage Gain, Phase vs. Frequency Characteristics (1)
(With no feedback capacitance)

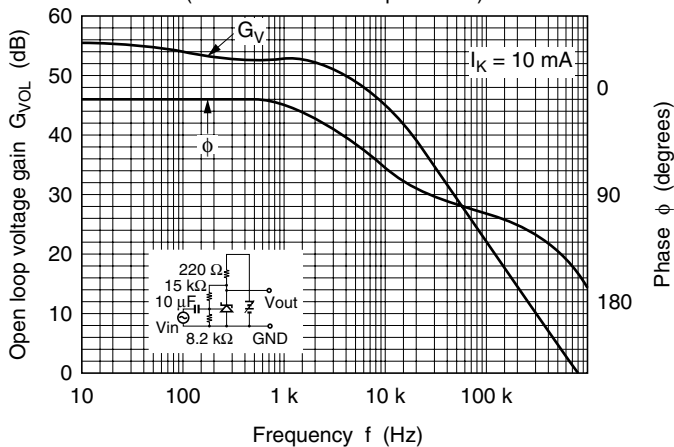

Open Loop Voltage Gain, Phase vs. Frequency Characteristics (2)
(When a feedback capacitance (C_f) is provided)

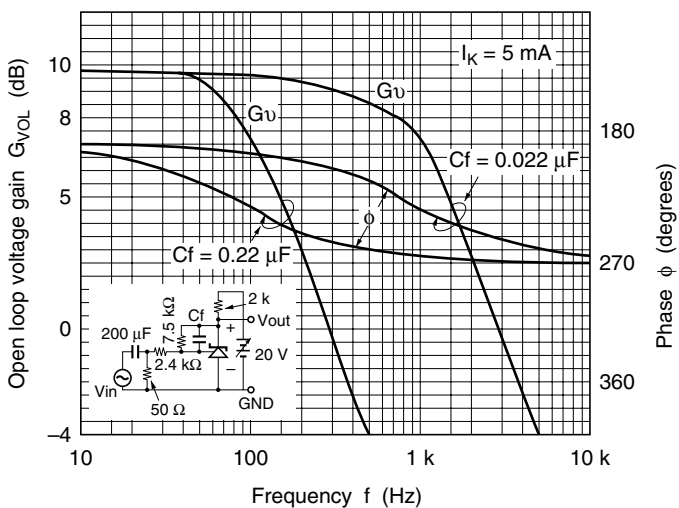

Reference Voltage Pin Input Current vs. Cathode Voltage Characteristics

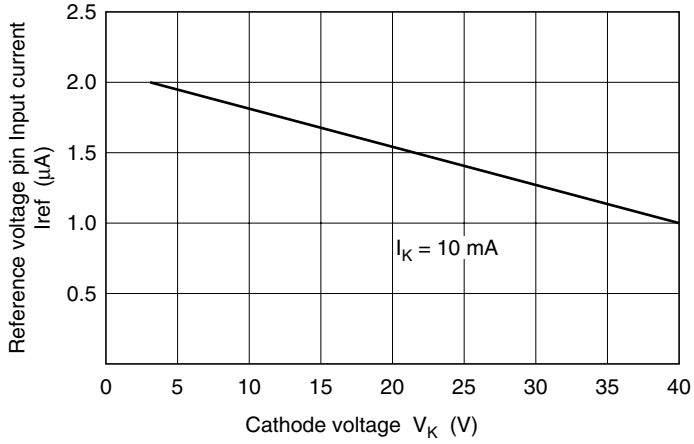

Pulse Response

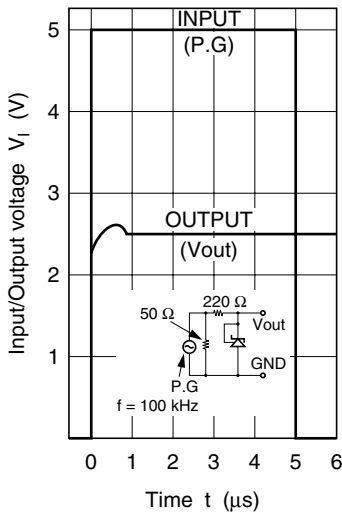

Reference Voltage Temperature Characteristics

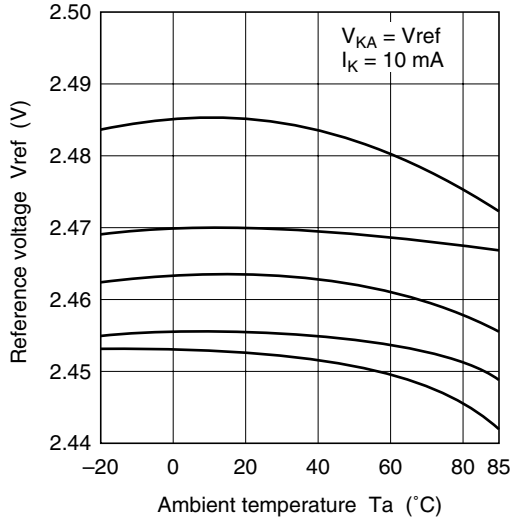

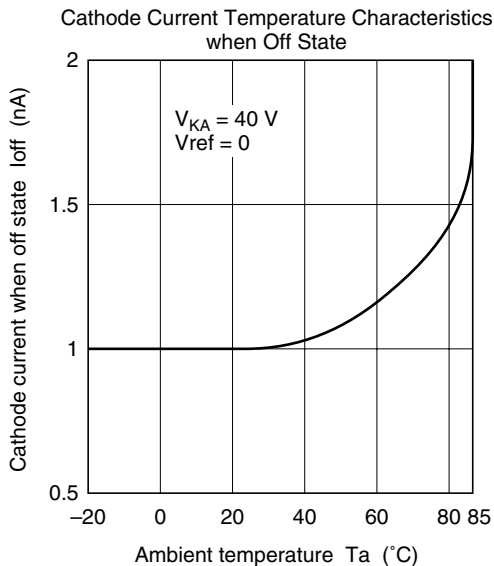
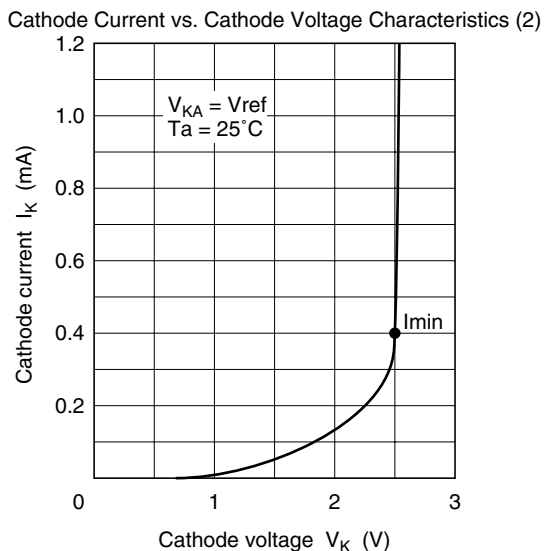
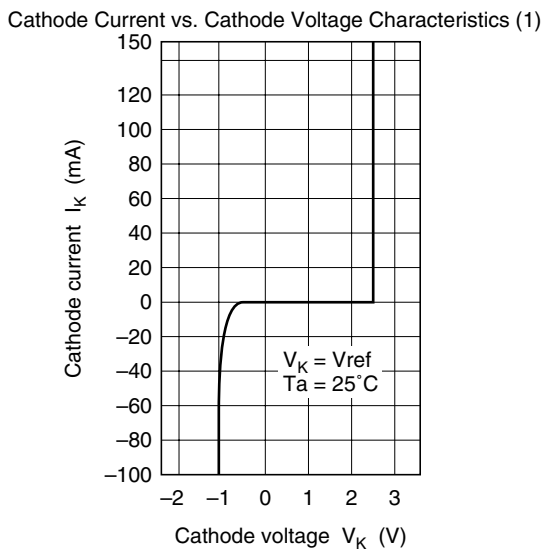
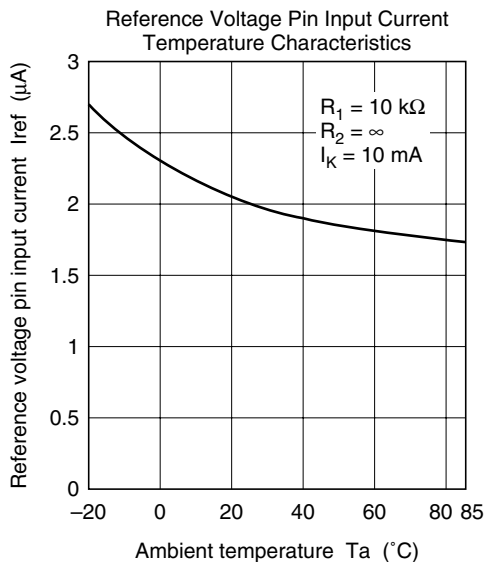

Application Examples

As shown in the figure on the right, this IC operates as an inverting amplifier, with the REF pin as input pin. The open-loop voltage gain is given by the reciprocal of “reference voltage deviation by cathode voltage change” in the electrical specifications, and is approximately 50 to 60 dB. The REF pin has a high input impedance, with an input current I_{ref} of $3.8 \mu\text{A Typ}$ (V version: $I_{ref} = 2 \mu\text{A Typ}$). The output impedance of the output pin K (cathode) is defined as dynamic impedance Z_{KA} , and Z_{KA} is low (0.2Ω) over a wide cathode current range. A (anode) is used at the minimum potential, such as ground.

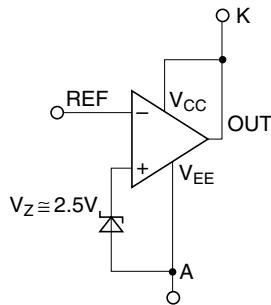
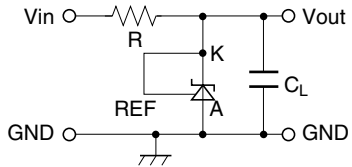
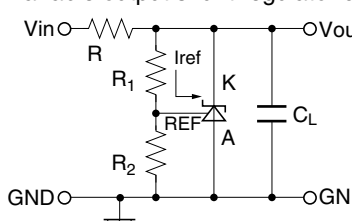

Figure 1 Operation Diagram

Application Hints

No.	Application Example	Description
1	Reference voltage generation circuit 	This is the simplest reference voltage circuit. The value of the resistance R is set so that cathode current $I_K \geq 1 \text{ mA}$. Output is fixed at $V_{out} \cong 2.5 \text{ V}$. The external capacitor C_L ($C_L \geq 3.3 \mu\text{F}$) is used to prevent oscillation in normal applications.
2	Variable output shunt regulator circuit 	This is circuit 1 above with variable output provided. Here, $V_{out} \cong 2.5 \text{ V} \times \frac{(R_1 + R_2)}{R_2}$ Since the reference input current $I_{ref} = 3.8 \mu\text{A Typ}$ (V version: $I_{ref} = 2 \mu\text{A Typ}$) flows through R_1 , resistance values are chosen to allow the resultant voltage drop to be ignored.

Application Hints (cont.)

No. Application Example

Description

3 Single power supply inverting comparator circuit

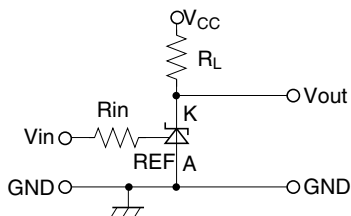

This is an inverting type comparator with an input threshold voltage of approximately 2.5 V. Rin is the REF pin protection resistance, with a value of several kΩ to several tens of kΩ.

RL is the load resistance, selected so that the cathode current $I_K \cdot 1 \text{ mA}$ when Vout is low.

Condition	Vin	Vout	IC
C1	Less than 2.5 V	V _{CC} (V _{OH})	OFF
C2	2.5 V or more	Approx. 2 V (V _{OL})	ON

4 AC amplifier circuit

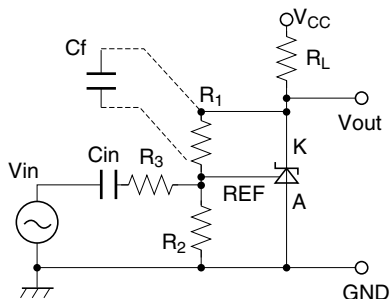

This is an AC amplifier with voltage gain $G = -R_1 / (R_2 // R_3)$. The input is cut by capacitance Cin, so that the REF pin is driven by the AC input signal, centered on $2.5 V_{DC}$.

R2 also functions as a resistance that determines the DC cathode potential when there is no input, but if the input level is low and there is no risk of Vout clipping to V_{CC}, this can be omitted.

To change the frequency characteristic, Cf should be connected as indicated by the dotted line.

$$\text{Gain } G = \frac{R_1}{R_2 // R_3} \text{ (DC gain)}$$

$$\text{Cutoff frequency } f_c = \frac{1}{2\pi C_f (R_1 // R_2 // R_3)}$$

5 Switching power supply error amplification circuit

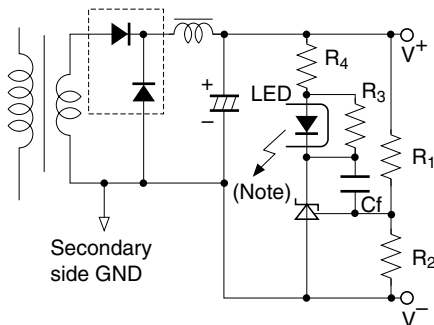

This circuit performs control on the secondary side of a transformer, and is often used with a switching power supply that employs a photocopler for offlining.

The output voltage (between V+ and V-) is given by the following formula:

$$V_{out} \cong 2.5 V \times \frac{(R_1 + R_2)}{R_2}$$

In this circuit, the gain with respect to the Vout error is as follows:

$$G = \frac{R_2}{(R_1 + R_2)} \times \left[\frac{\text{HA17431 open loop gain}}{\text{photocopler total gain}} \right]$$

Note: LED : Light emitting diode in photocopler
 R3 : Bypass resistor to feed $I_K (>I_{min})$ when LED current vanishes
 R4 : LED protection resistance

As stated earlier, the HA17431 open-loop gain is 50 to 60 dB.

Application Hints (cont.)

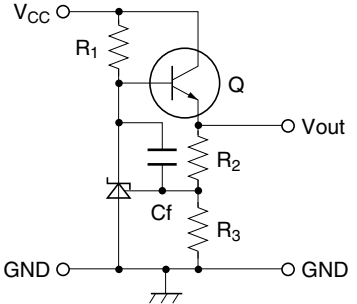
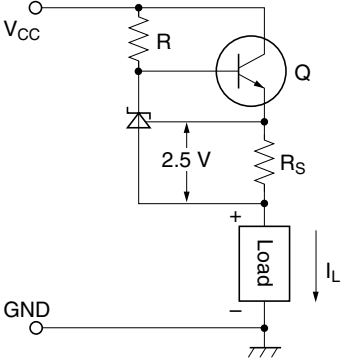
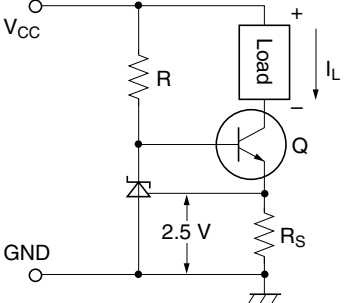
No.	Application Example	Description
6	Constant voltage regulator circuit	<p>This is a 3-pin regulator with a discrete configuration, in which the output voltage</p> $V_{out} = 2.5 \text{ V} \times \frac{(R_2 + R_3)}{R_3}$
		<p>R_1 is a bias resistance for supplying the HA17431 cathode current and the output transistor Q base current.</p>
7	Discharge type constant current circuit	<p>This circuit supplies a constant current of</p> $I_L \cong \frac{2.5 \text{ V}}{R_S} \text{ [A]}$ <p>into the load. Caution is required since the HA17431 cathode current is also superimposed on I_L.</p> <p>The requirement in this circuit is that the cathode current must be greater than $I_{min} = 1 \text{ mA}$. The I_L setting therefore must be on the order of several mA or more.</p>
		
8	Induction type constant current circuit	<p>In this circuit, the load is connected on the collector side of transistor Q in circuit 7 above. In this case, the load floats from GND, but the HA17431 cathode current is not superimposed on I_L, so that I_L can be kept small (1 mA or less is possible). The constant current value is the same as for circuit 7 above:</p> $I_L \cong \frac{2.5 \text{ V}}{R_S} \text{ [A]}$
		

Design Guide for AC-DC SMPS (Switching Mode Power Supply)

Use of Shunt Regulator in Transformer Secondary Side Control

This example is applicable to both forward transformers and flyback transformers. A shunt regulator is used on the secondary side as an error amplifier, and feedback to the primary side is provided via a photocoupler.

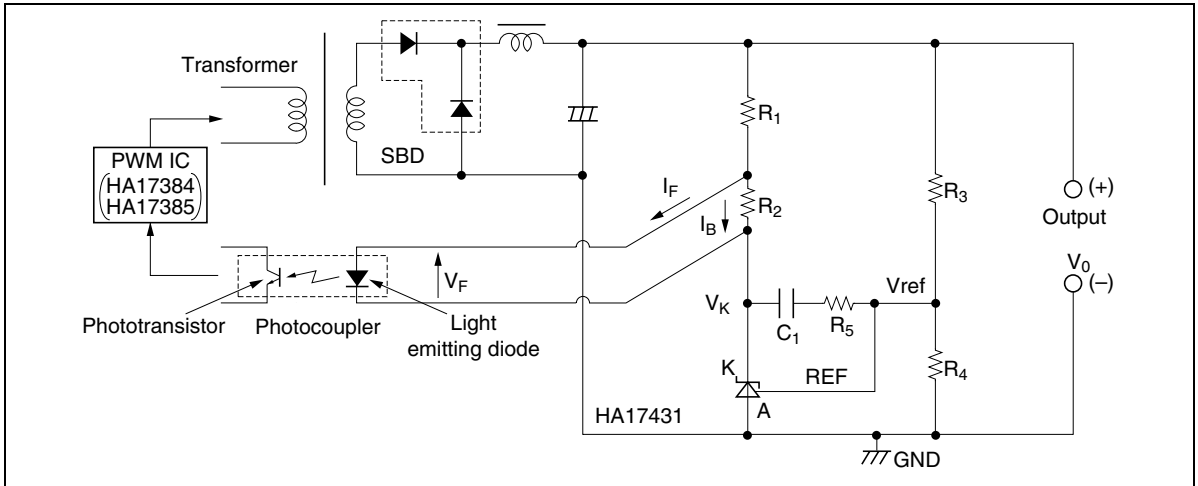

Figure 2 Typical Shunt Regulator/Error Amplifier

Determination of External Constants for the Shunt Regulator

DC characteristic determination: In figure 2, R_1 and R_2 are protection resistor for the light emitting diode in the photocoupler, and R_2 is a bypass resistor to feed I_K minimum, and these are determined as shown below. The photocoupler specification should be obtained separately from the manufacturer. Using the parameters in figure 2, the following formulas are obtained:

$$R_1 = \frac{V_0 - V_F - V_K}{I_F + I_B}, R_2 = \frac{V_F}{I_B}$$

V_K is the HA17431 operating voltage, and is set at around 3 V, taking into account a margin for fluctuation. R_2 is the current shunt resistance for the light emitting diode, in which a bias current I_B of around $1/5 I_F$ flows.

Next, the output voltage can be determined by R_3 and R_4 , and the following formula is obtained:

$$V_0 = \frac{R_3 + R_4}{R_4} \times V_{ref}, V_{ref} = 2.5 \text{ V Typ}$$

The absolute values of R_3 and R_4 are determined by the HA17431 reference input current I_{ref} and the AC characteristics described in the next section. The I_{ref} value is around $3.8 \mu\text{A Typ}$. (V version: $2 \mu\text{A Typ}$)

AC characteristic determination: This refers to the determination of the gain frequency characteristic of the shunt regulator as an error amplifier. Taking the configuration in figure 2, the error amplifier characteristic is as shown in figure 3.

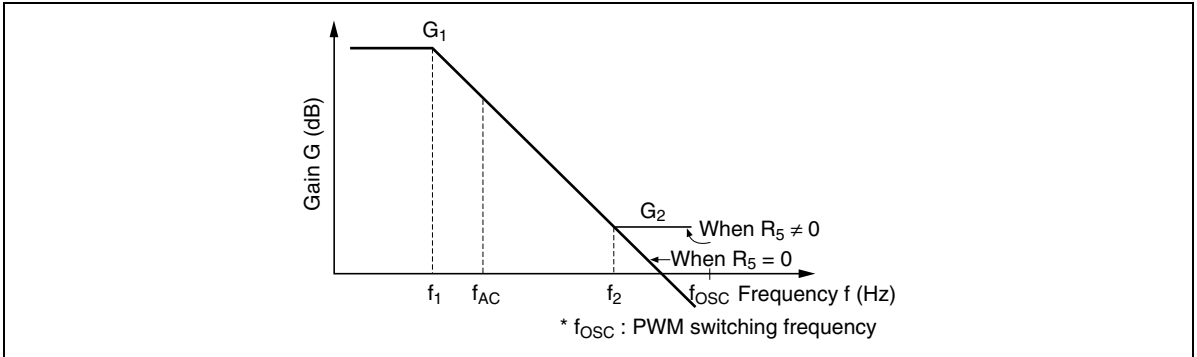

Figure 3 HA17431 Error Amplification Characteristic

In Figure 3, the following formulas are obtained:

Gain

$$G_1 = G_0 \approx 50 \text{ dB to } 60 \text{ dB (determined by shunt regulator)}$$

$$G_2 = \frac{R_5}{R_3}$$

Corner frequencies

$$f_1 = 1/(2\pi C_1 G_0 R_3)$$

$$f_2 = 1/(2\pi C_1 R_5)$$

G_0 is the shunt regulator open-loop gain; this is given by the reciprocal of the reference voltage fluctuation $\Delta V_{ref}/\Delta V_{KA}$, and is approximately 50 dB.

Practical Example

Consider the example of a photocoupler, with an internal light emitting diode $V_F = 1.05 \text{ V}$ and $I_F = 2.5 \text{ mA}$, power supply output voltage $V_2 = 5 \text{ V}$, and bias resistance R_2 current of approximately $1/5 I_F$ at 0.5 mA . If the shunt regulator $V_K = 3 \text{ V}$, the following values are found.

$$R_1 = \frac{5\text{V} - 1.05\text{V} - 3\text{V}}{2.5\text{mA} + 0.5\text{mA}} = 316(\Omega) \text{ (330}\Omega \text{ from E24 series)}$$

$$R_2 = \frac{1.05\text{V}}{0.5\text{mA}} = 2.1(\text{k}\Omega) \text{ (2.2k}\Omega \text{ from E24 series)}$$

Next, assume that $R_3 = R_4 = 10 \text{ k}\Omega$. This gives a 5 V output. If $R_5 = 3.3 \text{ k}\Omega$ and $C_1 = 0.022 \text{ }\mu\text{F}$, the following values are found.

$$G_2 = 3.3 \text{ k}\Omega / 10 \text{ k}\Omega = 0.33 \text{ times } (-10 \text{ dB})$$

$$f_1 = 1 / (2 \times \pi \times 0.022 \text{ }\mu\text{F} \times 316 \times 10 \text{ k}\Omega) = 2.3 \text{ (Hz)}$$

$$f_2 = 1 / (2 \times \pi \times 0.022 \text{ }\mu\text{F} \times 3.3 \text{ k}\Omega) = 2.2 \text{ (kHz)}$$

Package Dimensions

As of January, 2002

Unit: mm

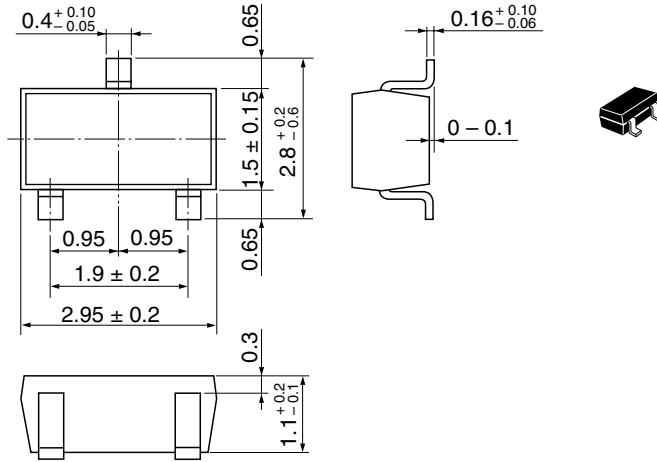

Hitachi Code	MPAK
JEDEC	—
JEITA	Conforms
Mass (reference value)	0.011 g

As of January, 2002

Unit: mm

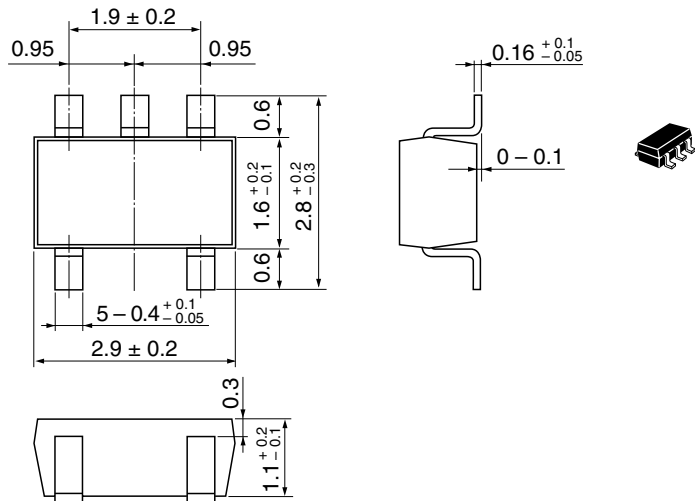

Hitachi Code	MPAK-5
JEDEC	—
JEITA	—
Mass (reference value)	0.015 g

As of January, 2002

Unit: mm

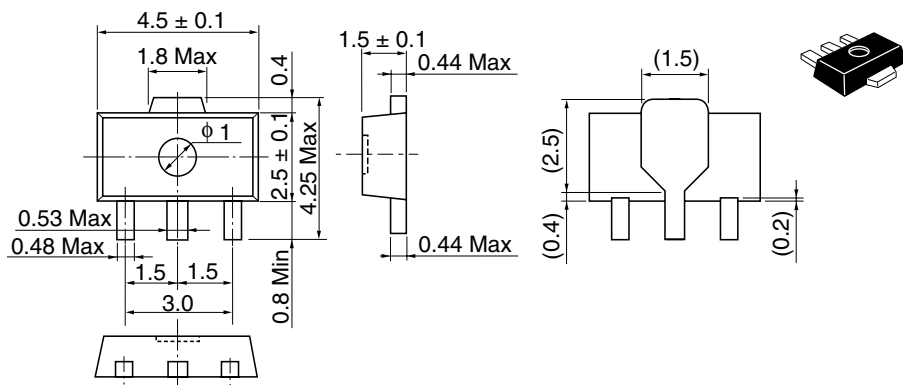

Hitachi Code	UPAK
JEDEC	—
JEITA	Conforms
Mass (reference value)	0.050 g

As of January, 2002

Unit: mm

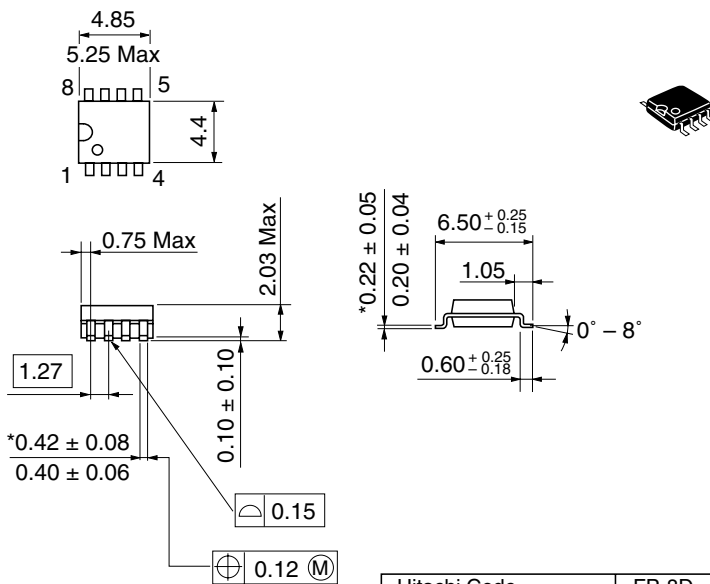

*Dimension including the plating thickness
Base material dimension

Hitachi Code	FP-8D
JEDEC	—
JEITA	Conforms
Mass (reference value)	0.10 g

As of January, 2002
Unit: mm

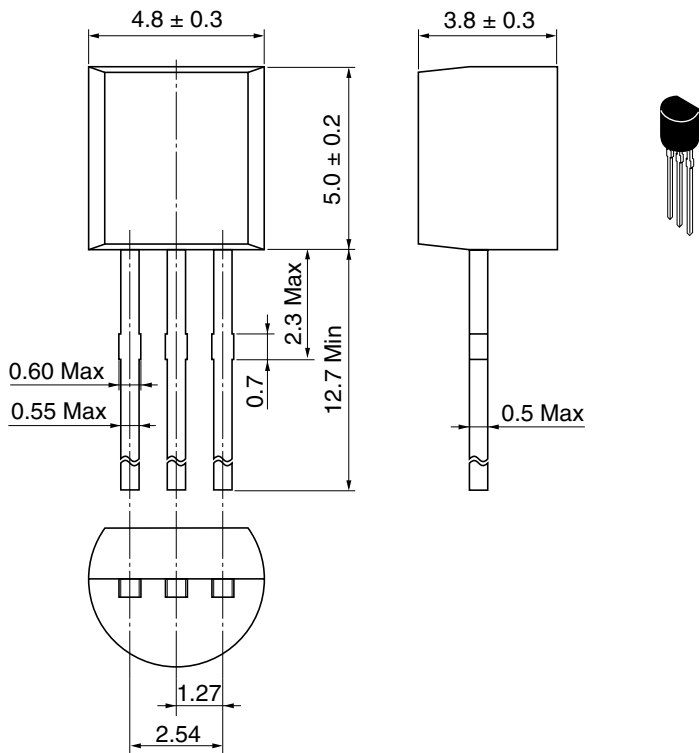

Hitachi Code	TO-92 (1)
JEDEC	Conforms
JEITA	Conforms
Mass (reference value)	0.25 g

As of January, 2002

Unit: mm

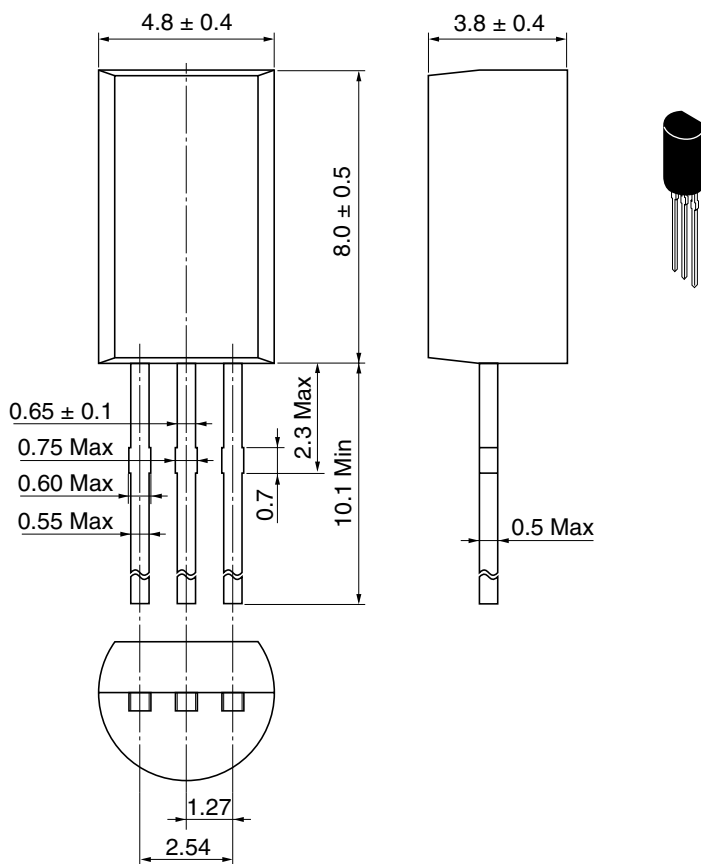

Hitachi Code	TO-92 Mod
JEDEC	—
JEITA	Conforms
Mass (reference value)	0.35 g

Disclaimer

1. Hitachi neither warrants nor grants licenses of any rights of Hitachi's or any third party's patent, copyright, trademark, or other intellectual property rights for information contained in this document. Hitachi bears no responsibility for problems that may arise with third party's rights, including intellectual property rights, in connection with use of the information contained in this document.
2. Products and product specifications may be subject to change without notice. Confirm that you have received the latest product standards or specifications before final design, purchase or use.
3. Hitachi makes every attempt to ensure that its products are of high quality and reliability. However, contact Hitachi's sales office before using the product in an application that demands especially high quality and reliability or where its failure or malfunction may directly threaten human life or cause risk of bodily injury, such as aerospace, aeronautics, nuclear power, combustion control, transportation, traffic, safety equipment or medical equipment for life support.
4. Design your application so that the product is used within the ranges guaranteed by Hitachi particularly for maximum rating, operating supply voltage range, heat radiation characteristics, installation conditions and other characteristics. Hitachi bears no responsibility for failure or damage when used beyond the guaranteed ranges. Even within the guaranteed ranges, consider normally foreseeable failure rates or failure modes in semiconductor devices and employ systemic measures such as fail-safes, so that the equipment incorporating Hitachi product does not cause bodily injury, fire or other consequential damage due to operation of the Hitachi product.
5. This product is not designed to be radiation resistant.
6. No one is permitted to reproduce or duplicate, in any form, the whole or part of this document without written approval from Hitachi.
7. Contact Hitachi's sales office for any questions regarding this document or Hitachi semiconductor products.

Sales Offices

HITACHI

Hitachi, Ltd.

Semiconductor & Integrated Circuits
Nippon Bldg., 2-6-2, Ohte-machi, Chiyoda-ku, Tokyo 100-0004, Japan
Tel: (03) 3270-2111 Fax: (03) 3270-5109

URL <http://www.hitachisemiconductor.com/>

For further information write to:

Hitachi Semiconductor
(America) Inc.
179 East Tasman Drive
San Jose, CA 95134
Tel: <1> (408) 433-1990
Fax: <1> (408) 433-0223

Hitachi Europe Ltd.
Electronic Components Group
Whitebrook Park
Lower Cookham Road
Maidenhead
Berkshire SL6 8YA, United Kingdom
Tel: <44> (1628) 585000
Fax: <44> (1628) 585200

Hitachi Europe GmbH
Electronic Components Group
Dornacher Straße 3
D-85622 Feldkirchen
Postfach 201, D-85619 Feldkirchen
Germany
Tel: <49> (89) 9 9180-0
Fax: <49> (89) 9 29 30 00

Hitachi Asia Ltd.
Hitachi Tower
16 Collyer Quay #20-00
Singapore 049318
Tel: <65>-6538-6533/6538-8577
Fax: <65>-6538-6933/6538-3877
URL: <http://semiconductor.hitachi.com.sg>

Hitachi Asia Ltd.
(Taipei Branch Office)
4/F, No. 167, Tun Hwa North Road
Hung-Kuo Building
Taipei (105), Taiwan
Tel: <886>-(2)-2718-3666
Fax: <886>-(2)-2718-8180
Telex: 23222 HAS-TP
URL: <http://www.hitachi.com.tw>

Hitachi Asia (Hong Kong) Ltd.
Group III (Electronic Components)
7/F., North Tower
World Finance Centre,
Harbour City, Canton Road
Tsim Sha Tsui, Kowloon Hong Kong
Tel: <852>-2735-9218
Fax: <852>-2730-0281
URL: <http://semiconductor.hitachi.com.hk>

Copyright © Hitachi, Ltd., 2002. All rights reserved. Printed in Japan.

Colophon 6.0