

GS1001FL THRU GS1010FL



1.0 Ampere Silion Rectifier

Features

- Lead Free Finish/Rohs Compliant (Note1) ("P" Suffix designates Compliant. See ordering information)
- Low Leakage Current
- Glass Passivated Junction
- Case Material: Molded Plastic. UL Flammability Classification Rating 94V-0 and MSL rating 1

1.0 Ampere Silion Rectifier 50 to 1000 Volts

Maximum Ratings

- Operating Temperature(Tj): -65°C to +175°C
- Storage Temperature(T_{STG}): -65°C to +175°C
- Typical Thermal Resistance(R_{thJA}): 50°C/W

MCC Part Number	Device Marking	Maximum Recurrent Peak Reverse Voltage	Maximum RMS Voltage	Maximum DC Blocking Voltage
GS1001FL	A1	50V	35V	50V
GS1002FL	A2	100V	70V	100V
GS1003FL	A3	200V	140V	200V
GS1004FL	A4	400V	280V	400V
GS1006FL	A5	600V	420V	600V
GS1008FL	A6	800V	560V	800V
GS1010FL	A7	1000V	700V	1000V

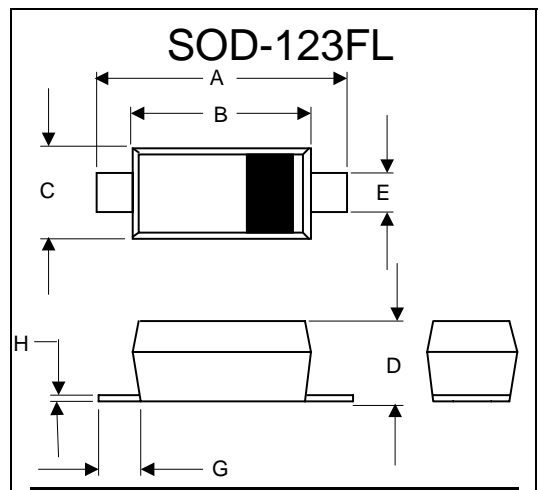

Electrical Characteristics @ 25°C Unless Otherwise Specified

Average Forward Current	I _{F(AV)}	1.0 A	T _A = 75°C
Peak Forward Surge Current	I _{FSM}	30.0 A	8.3ms, half sine
Maximum Instantaneous Forward Voltage	V _F	1.1V	T _A = 25°C I _F =1A
Maximum DC Reverse Current At Rated DC Blocking Voltage	I _R	5.0μA 50uA	T _A = 25°C T _A =100 °C
Maximum Full Load Reverse Current Average ,Full Cycle 9.5mm Lead Length	I _R	30uA	T _L =75 °C
Typical Junction Capacitance	C _J	15pF	Measured at 1.0MHz, V _R =4.0V

DIM	INCHES		MM		NOTE
	MIN	MAX	MIN	MAX	
A	.140	.152	3.55	3.85	
B	.100	.112	2.55	2.85	
C	.055	.071	1.40	1.80	
D	.037	.053	0.95	1.35	
E	.020	.039	0.50	1.00	
G	.010	-----	0.25	-----	
H	-----	.008	-----	.20	

SUGGESTED SOLDER PAD LAYOUT

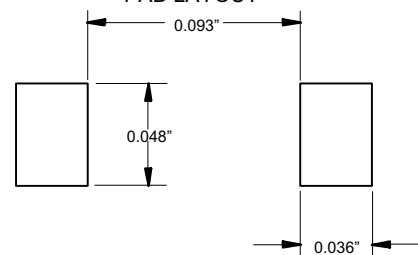

Note: 1. High Temperature Solder Exemptions Applied, see EU Directive Annex 7.

GS1001FL thru GS1010FL

Figure 1
Typical Forward Characteristics

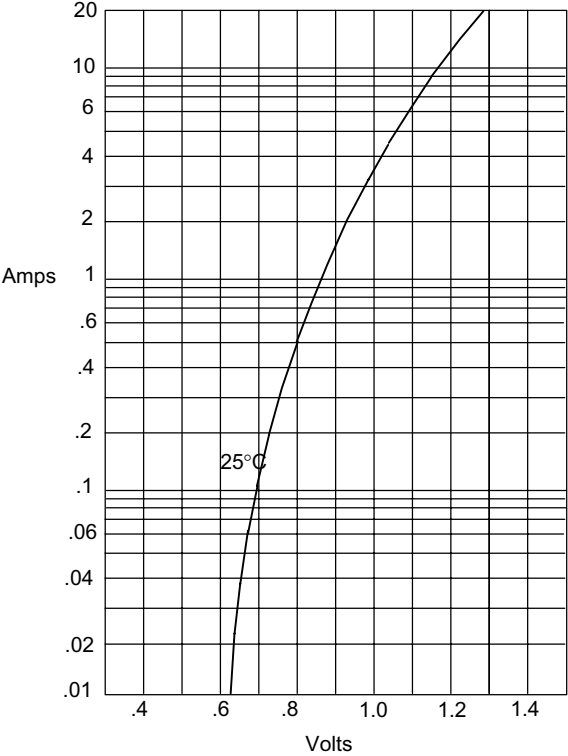

Instantaneous Forward Current - Amperes versus
Instantaneous Forward Voltage - Volts

Figure 2
Forward Derating Curve

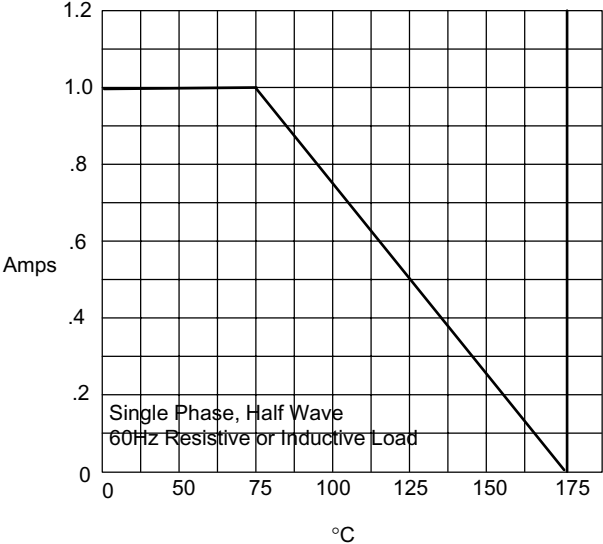

Single Phase, Half Wave
60Hz Resistive or Inductive Load

Average Forward Rectified Current - Amperes versus
Ambient Temperature - °C

Figure 3
Junction Capacitance

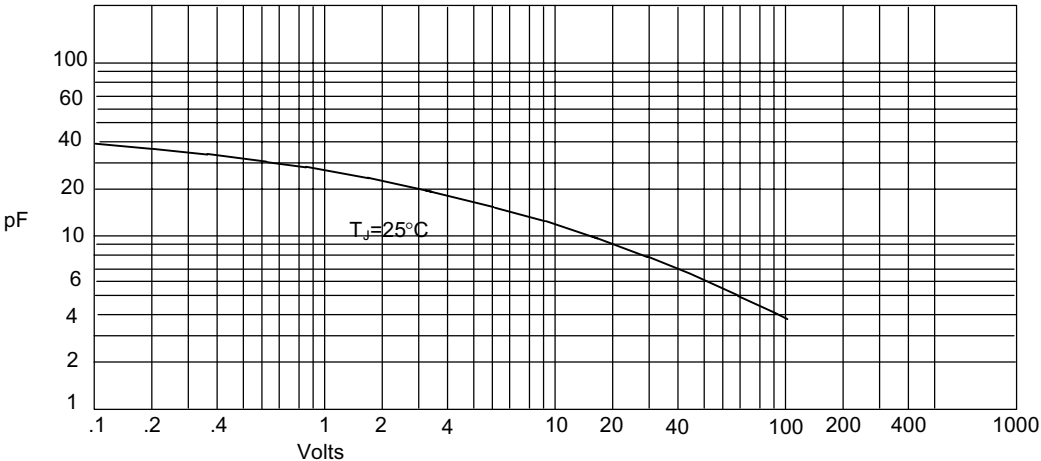

Junction Capacitance - pF versus
Reverse Voltage - Volts

GS1001FL thru GS1010FL

Figure 4
Typical Reverse Characteristics

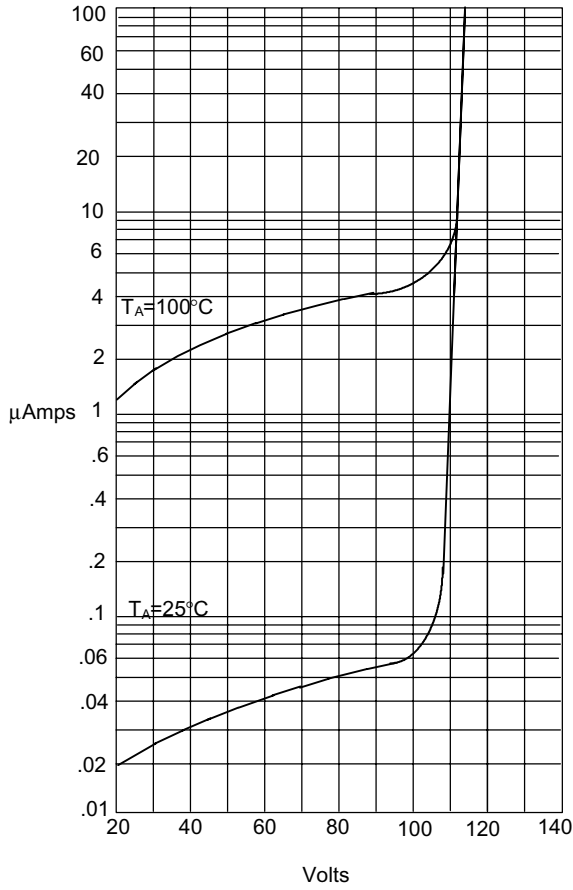

Instantaneous Reverse Leakage Current - MicroAmperes *versus*
Percent Of Rated Peak Reverse Voltage - Volts

Figure 5
Peak Forward Surge Current

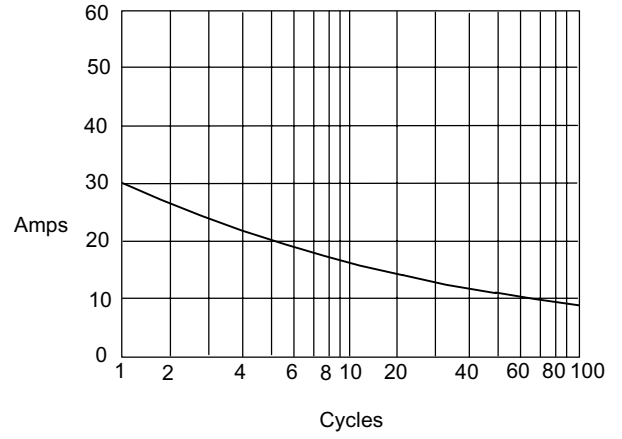

Peak Forward Surge Current - Amperes *versus*
Number Of Cycles At 60Hz - Cycles