

## GNR 22.5MM Series



- Current ratings 10, 20 and 30 amps
- Output voltage 24-280 and 48-600 VAC
- Direct Bond Copper (DBC) Substrate
- LED input status indicator
- 100K cycle UL508 Endurance Rating
- UL / CSA / TUV Approved, CE Compliant
- EMC Compliant Level 3
- DIN-RAIL or Panel Mount
- Zero-Crossing or Random Turn-on

### PRODUCT SELECTION

Control Voltage	10A	20A	30A
4-32 VDC	GNR10DHZ	GNR20DHZ	GNR30DHZ
90-140 VAC	GNR10BHZ	GNR20BHZ	GNR30BHZ
180-280 VAC	GNR10AHZ	GNR20AHZ	GNR30AHZ

### AVAILABLE OPTIONS

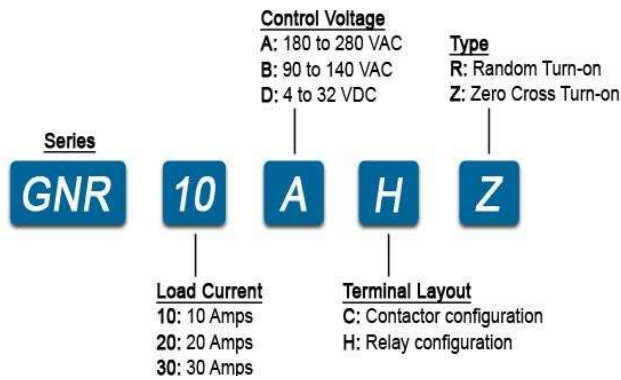

### OUTPUT SPECIFICATIONS (Voltage) (1)

Description	GNR10	GNR20/30
Operating Voltage (47-440Hz) [Vrms]	24-280	48-600
Transient Overvoltage [Vpk, t = 1 min.]	600	1100
Maximum Off-State Leakage Current @ Rated Voltage [mArms]	0.1	0.1
Static off-state dv/dt (V/μs, Ta = 25°C) (2)	500	500

### OUTPUT SPECIFICATIONS (Current) (1)

Description	GNR10x	GNR20x	GNR30x
Maximum Load Current [Arms]	10A	20A	30A
Minimum Load Current [mArms]	100	100	100
1 cycle surge current (50Hz)	190	286	716
1 cycle surge current (60Hz)	200	300	750
1 second surge current (Apk, Ta = 25°C) 50/60 Hz	65	85	150
Forward Voltage Drop (Vpk @ I <sub>max</sub> , Ta = 25°C)	1.5	1.35	1.35
I <sup>2</sup> T (50Hz, 1/2 cycle)	182	410	2562
I <sup>2</sup> T (60Hz, 1/2 cycle)	166	374	2334
HP Ratings at 120V / FLC	NA	1/2 / 9.8A	3/4 / 13.8A
HP Ratings at 240V / FLC	NA	1 / 8A	2 / 12A
Min/Max stranded wire	16/8 AWG	16/8 AWG	16/8 AWG
Min/Max solid wire	16/10 AWG	16/10 AWG	16/10 AWG

### INPUT SPECIFICATIONS (1)

Description	GNRxxDx	GNRxxBx	GNRxxAx
Input Voltage Range (3)	4-32 VDC	90-140VAC	180-280VAC
Minimum Turn-On Voltage	4.0 VDC	90 Vrms	180Vrms
Drop out Voltage	1.0 VDC	10 Vrms	10 Vrms
Maximum Input Current	19mA	23mA Arms	23mA Arms
Minimum input current (for on-state)	16mA	6mA Arms	8mA Arms
Input Resistance	Current Regulated	Current Regulated	Current Regulated
Turn-on time (4)	8.33ms	20ms	20ms
Turn-off time	8.33ms	30ms	30ms
Min/Max stranded/solid wire	24/16AWG	24/16AWG	24/16AWG

### GENERAL SPECIFICATIONS

Description	Parameters
Ambient Operating Temperature Range (3)	-20 to 80 °C
Ambient Storage Temperature Range	-40 to 100 °C
Input to output isolation	4000 Vrms
Input/output to ground isolation	2500 Vrms
Input to output capacitance	8 pF
Housing Material	UL 94V0 (self extinguishing)
Status Indicating Display	Green LED
Weight (typical)	0.5lbs (225 g)

### GENERAL NOTES

- 1) All parameters at 25°C unless otherwise specified.
- 2) Off-State dv/dt test method per EIA/NARM standard RS-433, paragraph 13.11.1
- 3) For 180-280VAC control, maximum Ambient operating temperature is 60°C
- 4) Random turn-on time R suffix is 100µs (for DC control only).

**MECHANICAL SPECIFICATIONS**

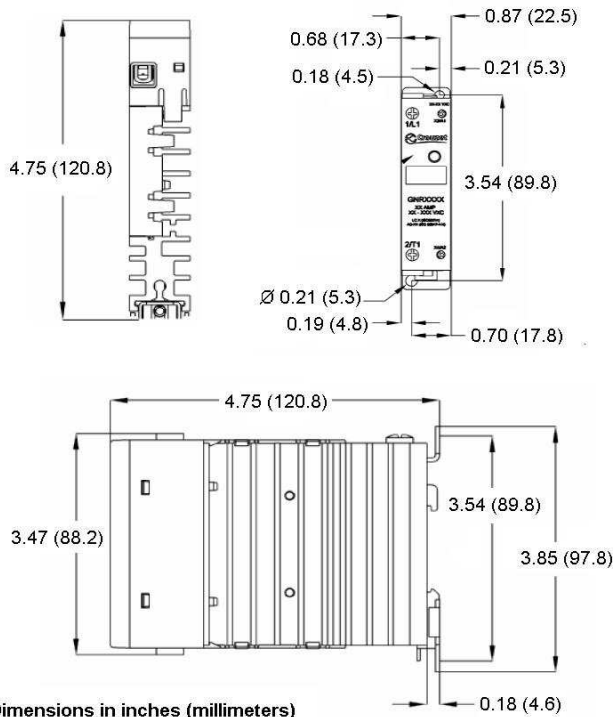

**WIRING DIAGRAM**

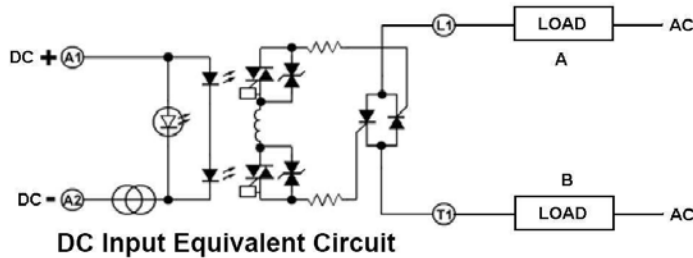

Load can be wired in position A or B

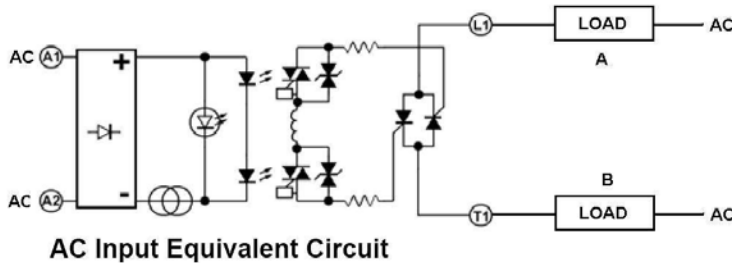

**THERMAL DERATE INFORMATION**

**CURRENT v. TEMP DERATE CURVE**  
**GNR10xxx 22.5MM SSR**

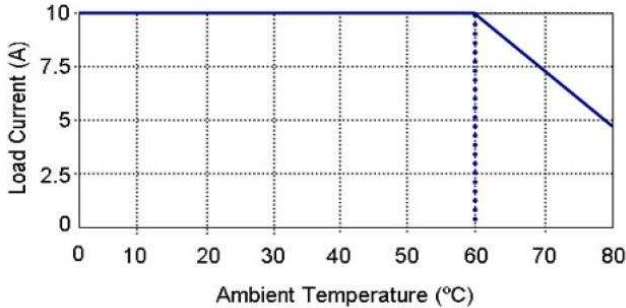

\*GNR10A Series rated to 60°C max ambient

**CURRENT v. TEMP DERATE CURVE**  
**GNR20xxx 22.5MM SSR**

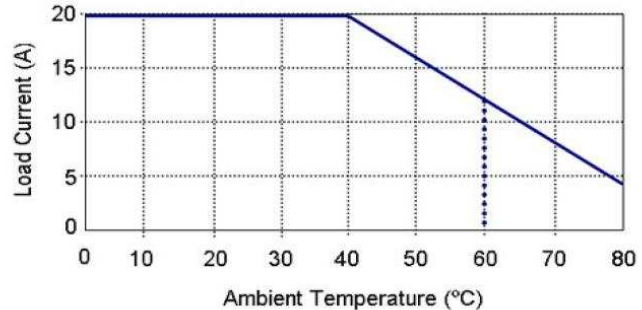

\*GNR20A Series rated to 60°C max ambient

**CURRENT v. TEMP DERATE CURVE**  
**GNR30xxx 22.5MM SSR**

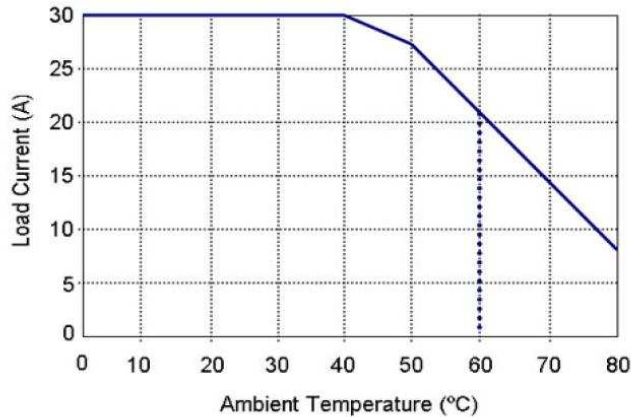

\*GNR30A Series rated to 60°C max ambient

**AGENCY APPROVALS**

Designed in accordance with the requirements of IEC 62314  
 IEC 60068-2-6 : 35mm/10-55Hz  
 IEC 60068-2-27 : 15G/11ms  
 IEC 61000-4-2 : Electrostatic Discharge – Level 3  
 IEC 61000-4-3 : Radiated Electromagnetic Noise – Level 3  
 IEC 61000-4-4 : Electrically Fast Transients – Level 3  
 IEC 61000-4-5 : Electrical Surges – Level 3  
 IEC 61000-4-6 : Conducted Electromagnetic Noise – Level 3  
 CISPIR 11 – Class A: Allowable Levels of Conducted and Radiated Noise for Industrial Environments



Rev. 041612

 <b>DANGER / PELIGRO / DANGER /GEFAHR / PERICOLO / PERIGO</b>					
<b>HAZARD OF ELECTRIC SHOCK, EXPLOSION, OR ARC FLASH.</b> <ul style="list-style-type: none"> <li>• Disconnect all power before installing or working with this equipment.</li> <li>• Verify all connections and replace all covers before turning on power.</li> </ul> <p>Failure to follow these instructions will result in death or serious injury.</p>	<b>RIESGO DE DESCARGA ELECTRICA O EXPLOSION.</b> <ul style="list-style-type: none"> <li>• Desconectar todos los suministros de energia a este equipo antes de trabajar con este equipo.</li> <li>• Verificar todas las conexiones y colocar todas las tapas antes de energizar el equipo.</li> </ul> <p>El incumplimiento de estas instrucciones puede provocar la muerte o lesiones serias.</p>	<b>RISQUE DE DESCARGE ELECTRIQUE OU EXPLOSION</b> <ul style="list-style-type: none"> <li>• Eteindre toutes les sources d'énergie de cet appareil avant de travailler dessus de cet appareil</li> <li>• Vérifier tous connections, et remettre tous couverts en place avant de mettre sous</li> </ul> <p>De non-suivi de ces instructions provoquera la mort ou des lésions sérieuses.</p>	<b>GEFAHR EINES ELEKTRISCHE N SCHLAGES ODER EINER EXPLOSION.</b> <ul style="list-style-type: none"> <li>• Stellen Sie jeglichen Strom ab, der dieses Gerät versorgt, bevor Sie an dem Gerät Arbeiten durchführen</li> <li>• Vor der Inbetriebnahme alle Anschlüsse überprüfen und alle Gehäuseteile montieren.</li> </ul> <p>Unterlassung dieser Anweisungen können zum Tode oder zu schweren Verletzungen führen.</p>	<b>RISCHIO DI SCOSSA ELETTRICA O DELL'ESPLOSIONE.</b> <ul style="list-style-type: none"> <li>• Spenga tutta l'alimentazione e che fornisce questa apparecchiatura prima del lavorare a questa apparecchiatura</li> <li>• Verificare tutti i collegamenti e sostituire tutte le coperture prima della rotazione sull'alimentazione</li> </ul> <p>L'omissione di seguire queste istruzioni provocherà la morte o di lesioni serie</p>	<b>RISCO DE DESCARGA ELÉTRICA OU EXPLOÇÃO</b> <ul style="list-style-type: none"> <li>• Desconectar o equipamento de toda a energia antes de instalar ou trabalhar com este equipamento</li> <li>• Verificar todas as conexões e recolocar todas as tampas antes de religar o equipamento</li> </ul> <p>O não cumprimento destas instruções pode levar à morte ou lesões sérias.</p>

 <b>WARNING / AVERTISSEMENT / WARNUNG /ADVERTENCIA / AVVERTENZA / AVISO</b>		
<b>RISK OF MATERIAL DAMAGE AND HOT ENCLOSURE</b> <ul style="list-style-type: none"> <li>• The product's side panels may be hot, allow time for product to cool before touching.</li> <li>• Follow proper mounting instructions including torque values.</li> <li>• Do not allow liquids or foreign objects to enter this product.</li> </ul> <p>Failure to follow this instruction can result in serious injury, or equipment damage.</p>	<b>RISQUE DE DOMMAGE MATERIEL ET DE SURCHAUFFE DU BOITIER</b> <ul style="list-style-type: none"> <li>• Les panneaux latéraux du produit peuvent être chauds. Laisser le produit refroidir avant de le toucher.</li> <li>• Respecter les consignes de montage, et notamment les couples de serrage.</li> <li>• Ne pas laisser pénétrer de liquide ni de corps étrangers à l'intérieur du produit.</li> </ul> <p>Le non-respect de cette directive peut entraîner, des lésions corporelles graves ou des dommages matériels.</p>	<b>GEFAHR VON MATERIALSCHÄDEN UND GEHÄUSEERHITZUNG</b> <ul style="list-style-type: none"> <li>• Die Seitenwände können heiß sein. Lassen Sie das Produkt abkühlen, bevor Sie es berühren.</li> <li>• Beachten Sie die Montageanweisungen,</li> <li>• Führen Sie keine Flüssigkeiten oder Fremdkörper in das Produkt ein.</li> </ul> <p>Die Nichtbeachtung dieser Anweisung kann Körperverletzung oder Materialschäden zur Folge haben.</p>
<b>RIESGO DE DAÑOS MATERIALES Y DE SOBRECALENTAMIENTO DE LA UNIDAD</b> <ul style="list-style-type: none"> <li>• Los paneles laterales del producto pueden estar calientes. Esperar que el producto se enfríe antes de tocarlo.</li> <li>• Respetar las instrucciones de montaje, y en particular los pares de apretado.</li> <li>• No dejar que penetren líquidos o cuerpos extraños en el producto.</li> </ul> <p>Si no se respetan estas precauciones pueden producirse graves lesiones, daños materiales.</p>	<b>RISCHIO DI DANNI MATERIALI E D'INVOLUCRO CALDO</b> <ul style="list-style-type: none"> <li>• I pannelli laterali dell'apparecchio possono scottare; lasciar quindi raffreddare il prodotto prima di toccarlo.</li> <li>• Seguire le istruzioni di montaggio corrette.</li> <li>• Non far entrare liquidi o oggetti estranei in questo apparecchio.</li> </ul> <p>La mancata osservanza di questa precauzione può causare gravi rischi per l'incolumità personale o danni alle apparecchiature.</p>	<b>RISCO DE DANO MATERIAL E DE AQUECIMENTO</b> <ul style="list-style-type: none"> <li>• Os painéis laterais do produto podem estar quentes; dê tempo ao produto para arrefecer antes de lhe tocar.</li> <li>• Siga devidamente as instruções de montagem.</li> <li>• Não permita a entrada de líquidos e de objectos estranhos no produto.</li> </ul> <p>A não observância destas precauções pode provocar a morte, ferimentos graves ou danos materiais.</p>

### ANNEX - ENVIROMENTAL INFORMATION

The environmental information disclosed in this annex including the EIP Pollution logo are in compliance with People's Republic of China Electronic Industry Standard SJ/T11364 – 2006, Marking for Control of Pollution Caused by Electronic Information Products.

Part Name	Toxic or hazardous Substance and Elements					
	Lead (Pb)	Mercury (Hg)	Cadmium (Cd)	Hexavalent Chromium (Cr (VI))	Polybrominated biphenyls (PBB)	Polybrominated diphenyl ethers (PBDE)
Semiconductor die	X	○	○	○	○	○
Solder	X	○	○	○	○	○

此附件所标示的包括电子信息产品污染图标的环保信息符合中华人民共和国电子行业标准 **SJ/T11364 - 2006**, 电子信息产品污染控制标识要求



部件名称	有毒有害物质或元素					
	铅 (Pb)	汞 (Hg)	镉 (Cd)	六价铬 (Cr (VI))	多溴联苯 (PBB)	多溴二苯醚 (PBDE)
半导体芯片	X	○	○	○	○	○
焊接点	X	○	○	○	○	○