

Super-luminosity/High-luminosity Numeric LED

■ Super-luminosity/High-luminosity Numeric LED Figures shown below are values per segment.

(Ta=25°C)

Digit	Type	Character height (mm)	Type of display	Common pins	U (Red)		T (Red)		Outline dimensions	
					Model No.	Luminous intensity (mcd)	Model No.	Luminous intensity (mcd)	Page	Figure
						TYP.		TYP.		
1-digit	Mold Type	8.0		A			GL9T030	4.0	→	10
				K			GL8T030	4.0		
		10.16		A			GL9T040	4.25		9
				K			GL8T040	4.25		
		14.12		A			GL9T156	5.25		8
				K			GL8T156	5.25		
	20.32		A			GL9T08	2.2	6		
			K			GL8T08	2.2			
	25.4		A		GL9U100	35.0	GL9T100	9.5	→	4
			K		GL8U100	35.0	GL8T100	9.5		
	38.1		A		GL9U15	27.0			→	3
			K		GL8U15	27.0				
Substrate Type	76.0		A		GL9U30	(120)*			→	1
			K		GL8U30	(120)*				
Multi-digits	Mold Type	10.16		A			GL7T201	4.25	→	12
				K			GL6T201	4.25		
	8.0		A			GL3T422	1.5	→	19	
			K			GL3T421	1.5			
	7.6		A			GL3T508D	1.5	→	21	
			K			GL3T507D	1.5			

*1 A: Anode common K: Cathode common * Production after order confirmation

* As for current conditions, refer to If in electro-optical characteristics

■ Absolute Maximum Ratings Figures shown below are values per segment.

(Ta=25°C)

Character height (mm)	Radiation color	Forward current IF (mA)	Peak forward current IFM*1 (mA)	Derating factor (mA/°C)		Reverse voltage VR (V)	Operating temperature Topr. (°C)	Storage temperature Tstg. (°C)
				DC	Pulse			
8.0/10.16/14.12/20.32	T	20	100	0.36	1.82	5	-30 to +70	-40 to +80
25.4, 38.1, 76.0	U	20	150*2	0.36	2.73	6	-30 to +70	-40 to +80
25.4, 38.1	T	20	100	0.36	1.82	5	-30 to +70	-40 to +80

*1 Duty ratio=1/10, Pulse width=0.1ms

*2 U type duty ratio=1/16, pulse width=0.1ms

■ Electro-optical Characteristics Figures shown below are values per segment.

(Ta=25°C)

Character height (mm)	Radiation color	Forward current VF		Peak emission wavelength λp(nm) TYP.	Spectrum radiation bandwidth Δλ(nm) TYP.		IF (mA)	Reverse current IR(μA) MAX. VR (V)	
		TYP.	MAX.						
8.0/10.16/14.12/20.32	T	1.7	2.2	660	20	10	10	4	
25.4, 38.1, 76.0	U	3.5	4.8	660	20	10	100	5	
25.4, 38.1	T	3.4	4.4	660	20	10	10	4	

(Notice) • In the absence of confirmation by device specification sheets, SHARP takes no responsibility for any defects that may occur in equipment using any SHARP devices shown in catalogs, data books, etc. Contact SHARP in order to obtain the latest device specification sheets before using any SHARP device.

(Internet) • Data for sharp's optoelectronic/power device is provided for internet.(Address <http://www.sharp.co.jp/ecg/>)

Numeric LED Characteristics Diagrams

T series

Forward Current Derating Curve

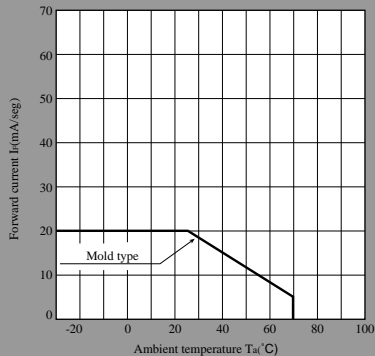

Forward Current vs. Forward Voltage*

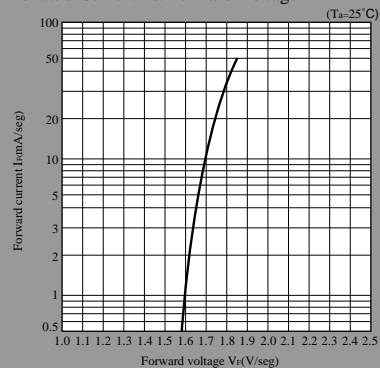

Luminous Intensity vs. Ambient Temperature

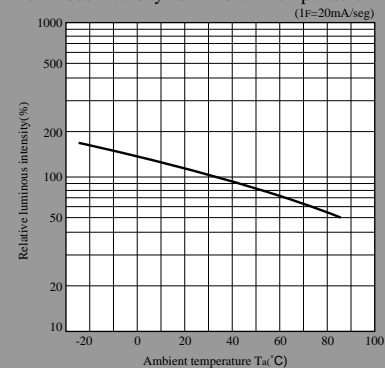

Peak Forward Current Derating Curve

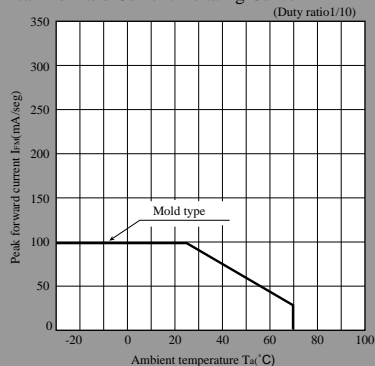

Luminous Intensity vs. Forward Current

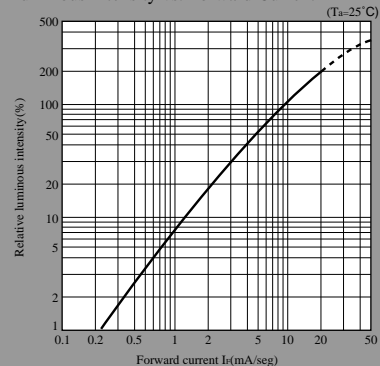

Duty Ratio vs. Peak Forward Current

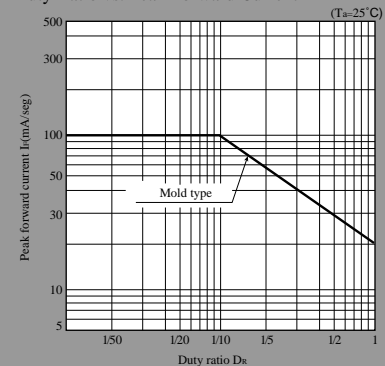

* In case of 25.4mm: value per 1segment 1chip

U series

Forward Current Derating Curve

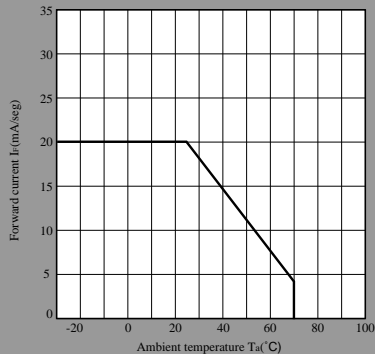

Forward Current vs. Forward Voltage* (T_a=25°C)

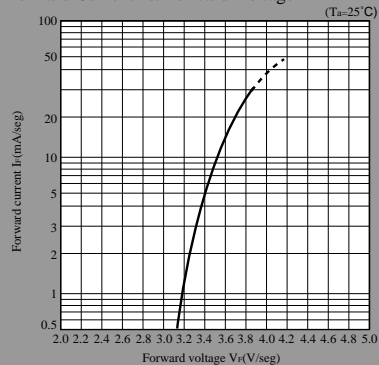

Luminous Intensity vs. Ambient Temperature (I_f=20mA)

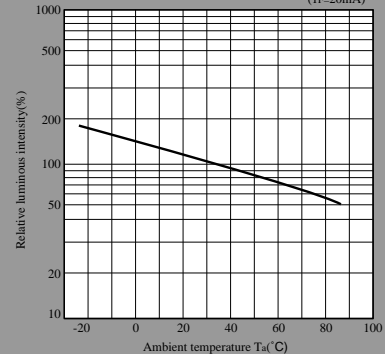

Peak Forward Current Derating Curve (Duty ratio/10)

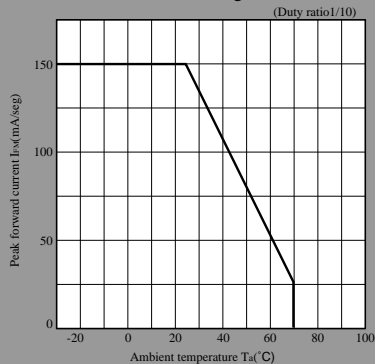

Luminous Intensity vs. Forward Current (T_a=25°C)

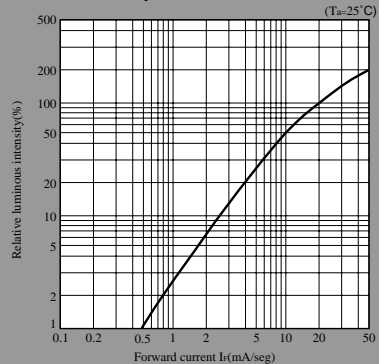

Duty Ratio vs. Peak Forward Current (T_a=25°C)

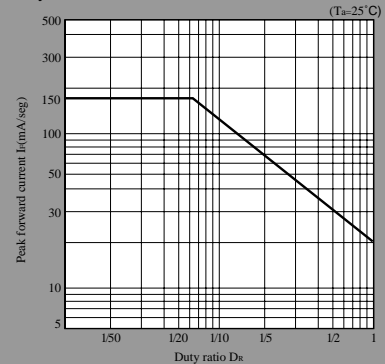

* In case of 25.4/38.1/76.0mm: value per 1segment 1chip

- (Notice) • In the absence of confirmation by device specification sheets, SHARP takes no responsibility for any defects that may occur in equipment using any SHARP devices shown in catalogs, data books, etc. Contact SHARP in order to obtain the latest device specification sheets before using any SHARP device.
- (Internet) • Data for sharp's optoelectronic/power device is provided for internet.(Address <http://www.sharp.co.jp/ecg/>)

Numeric LED Outline Dimensions(Unit:mm)

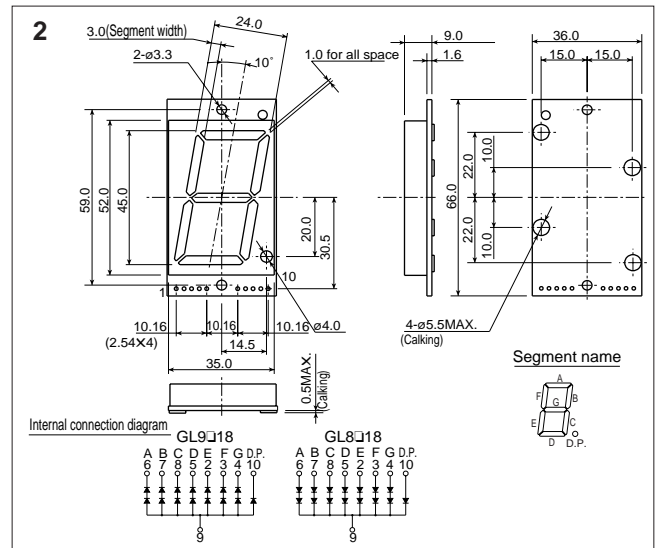
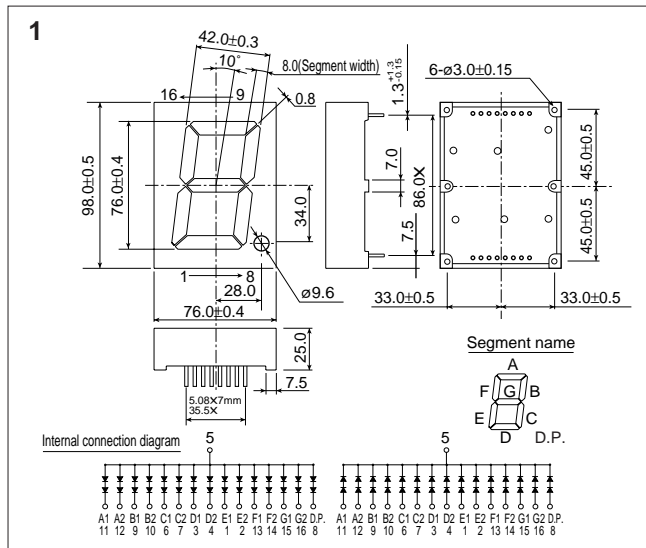

GL9□30 Series GL8□30 Series

GL9□18 Series GL8□18 Series

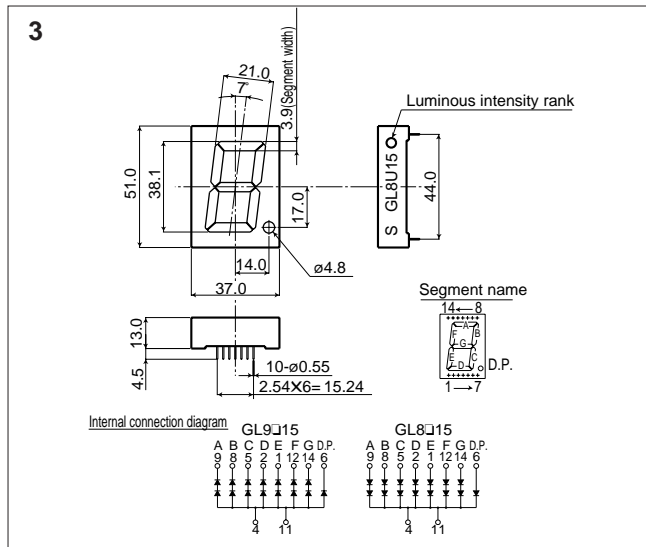

GL9□15 Series GL8□15 Series

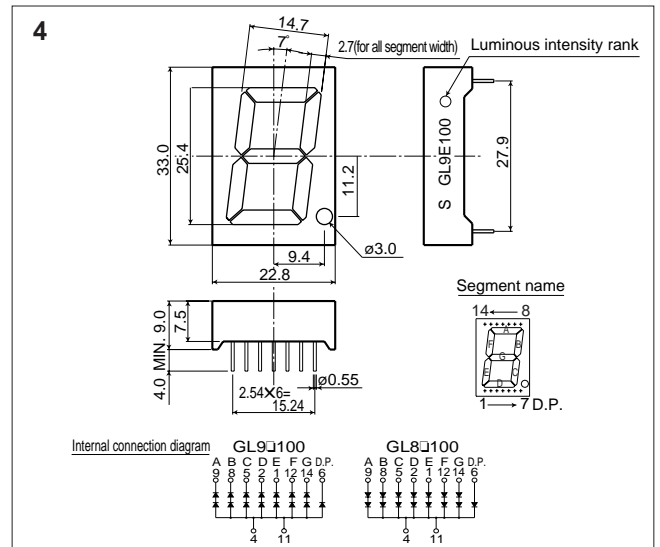

GL9□100 Series GL8□100 Series

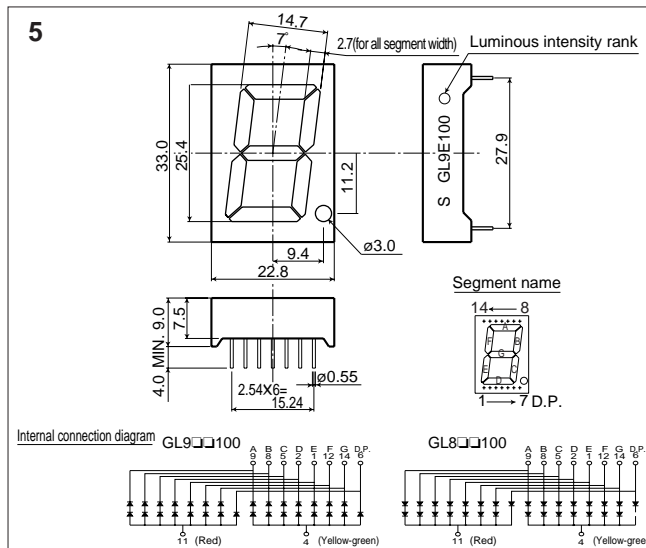

GL9□□100 Series GL8□□100 Series

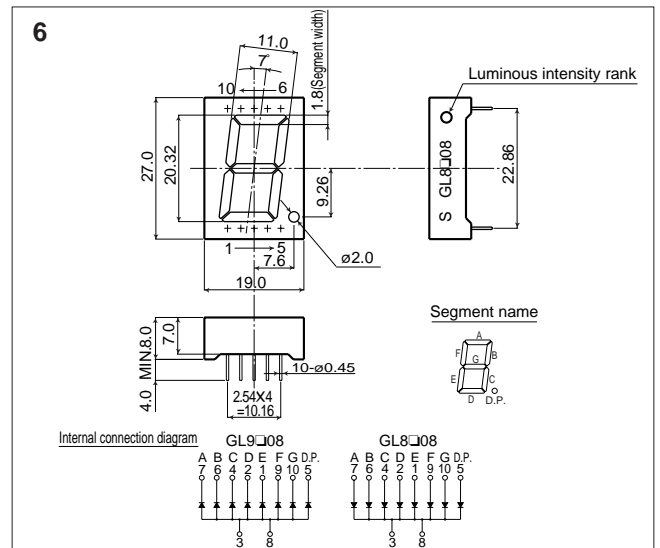

GL9□08 Series GL8□08 Series

(Notice) • In the absence of confirmation by device specification sheets, SHARP takes no responsibility for any defects that may occur in equipment using any SHARP devices shown in catalogs, data books, etc. Contact SHARP in order to obtain the latest device specification sheets before using any SHARP device.
 (Internet) • Data for sharp's optoelectronic/power device is provided for internet.(Address <http://www.sharp.co.jp/ecg/>)

Numeric LED Outline Dimensions(Unit:mm)

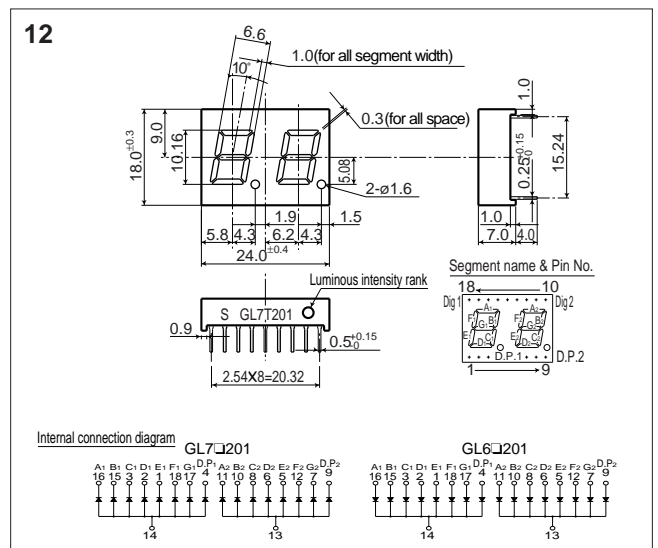
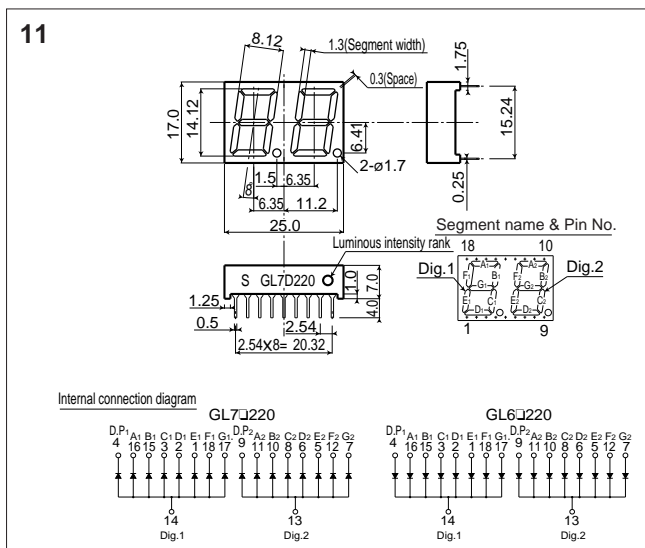
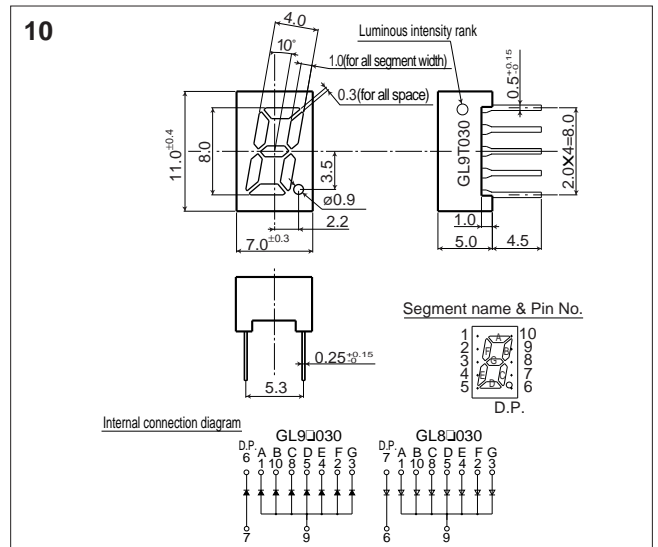
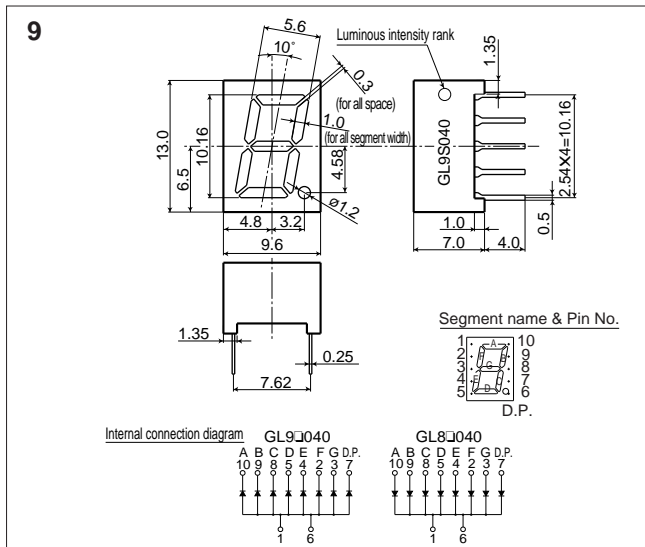
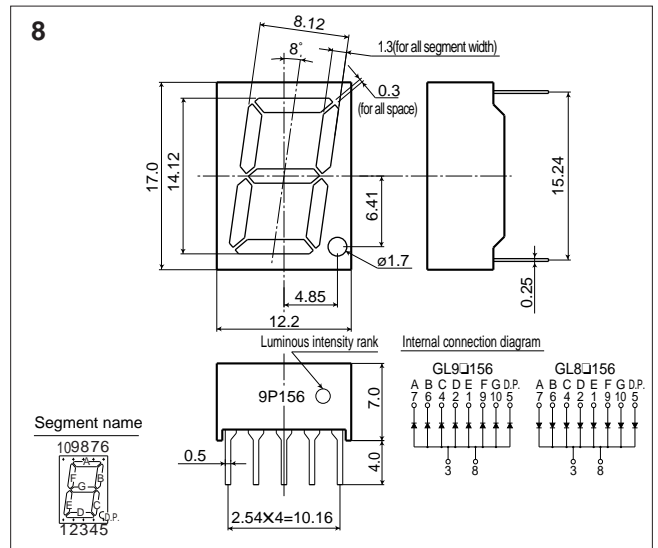
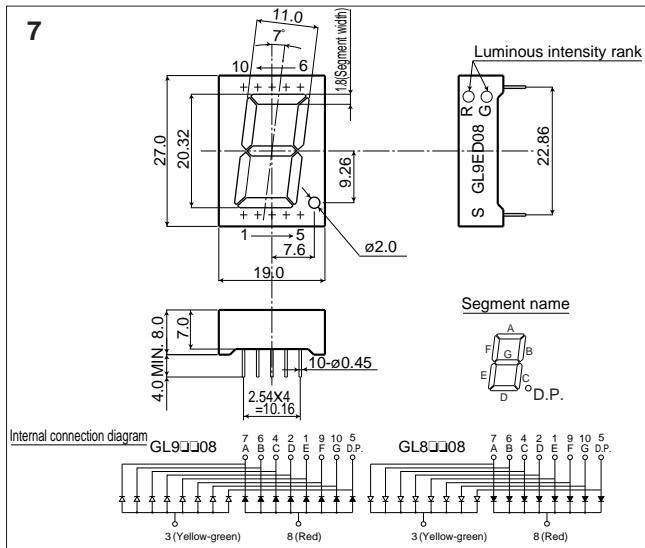

Numeric LED Outline Dimensions(Unit:mm)

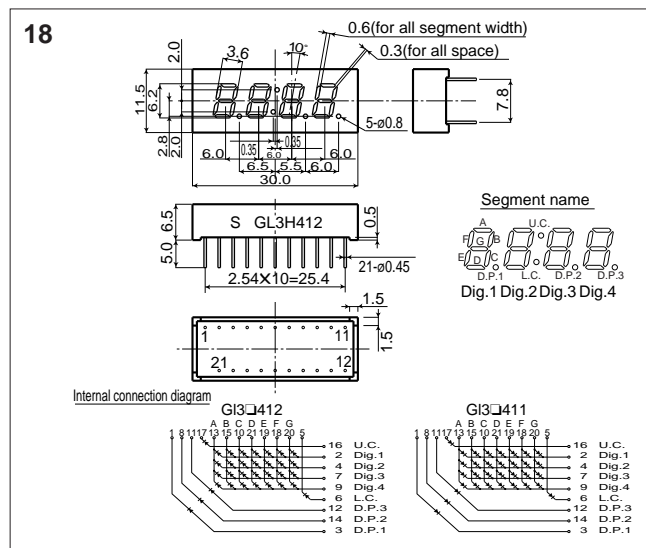
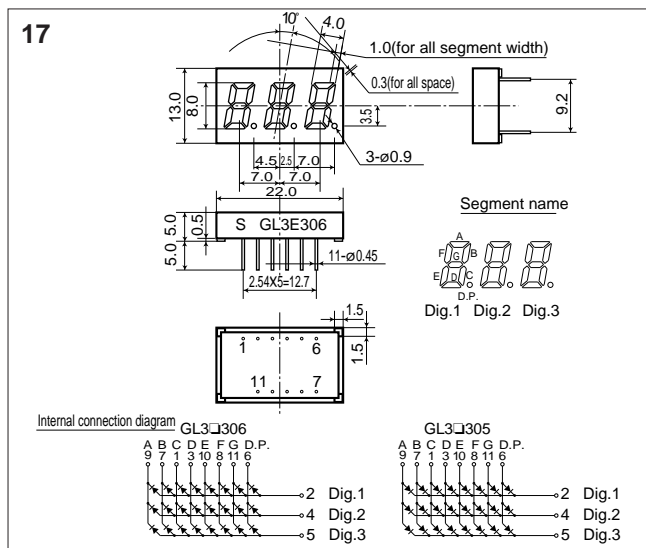
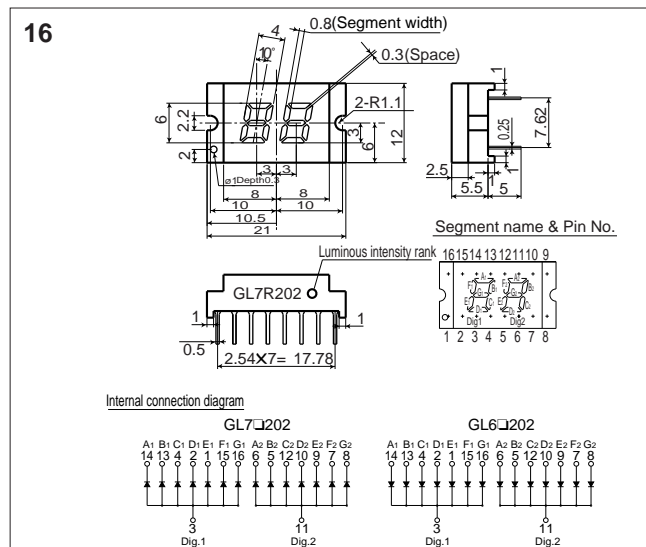
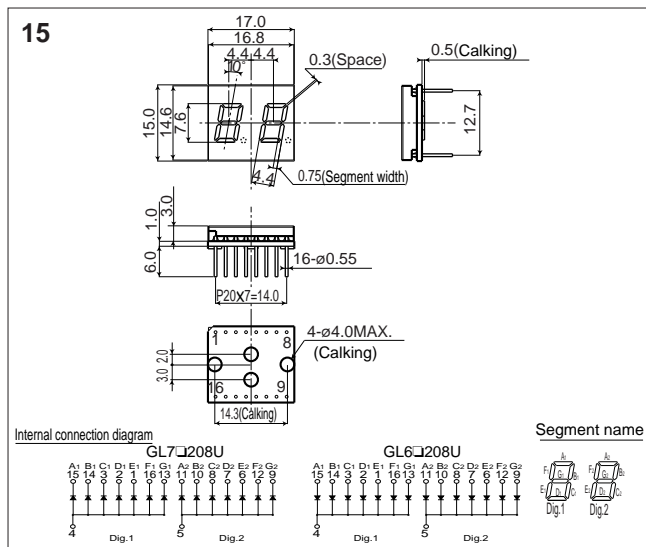
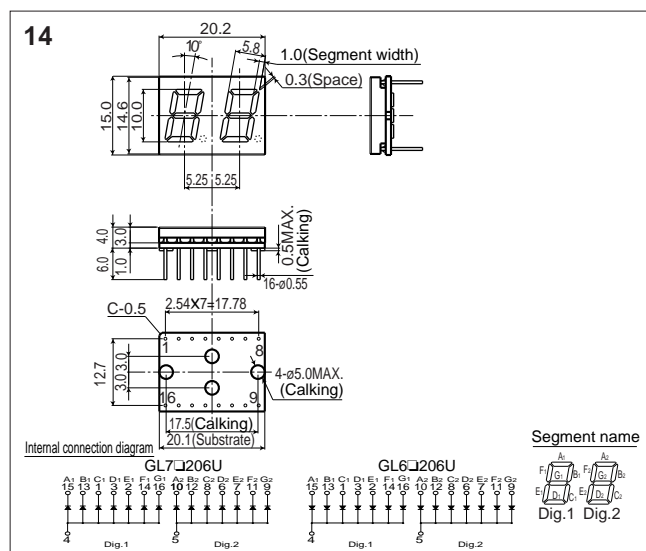
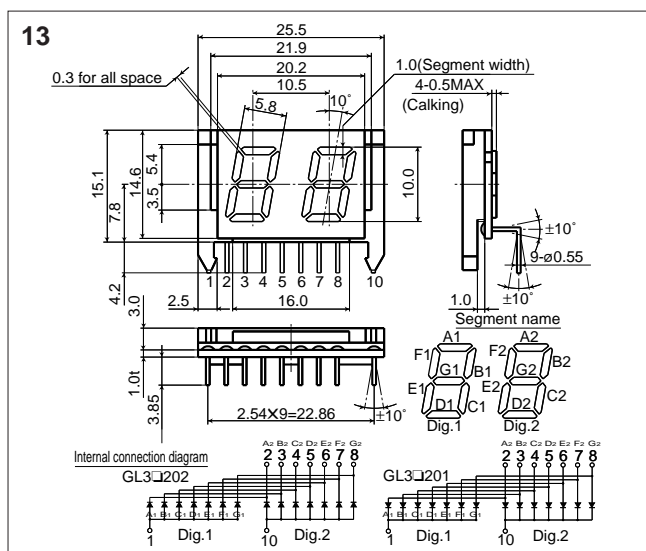

(Notice) ● In the absence of confirmation by device specification sheets, SHARP takes no responsibility for any defects that may occur in equipment using any SHARP devices shown in catalogs, data books, etc. Contact SHARP in order to obtain the latest device specification sheets before using any SHARP device.
(Internet) ● Data for sharp's optoelectronic/power device is provided for internet.(Address <http://www.sharp.co.jp/ecg/>)

Numeric LED Outline Dimensions(Unit:mm)

19

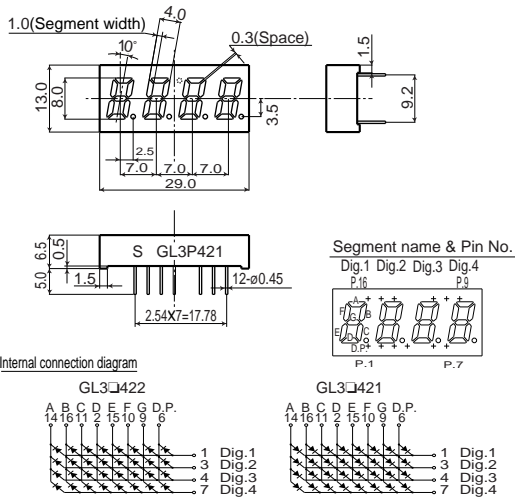

GL3□422 Series GL3□421 Series

20

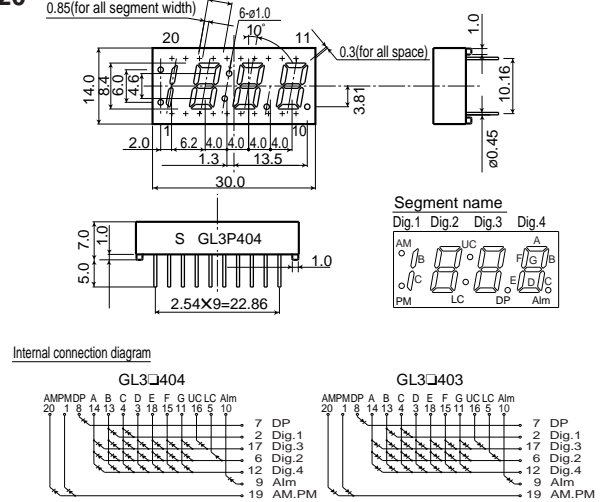

GL3□404 Series GL3□403 Series

21

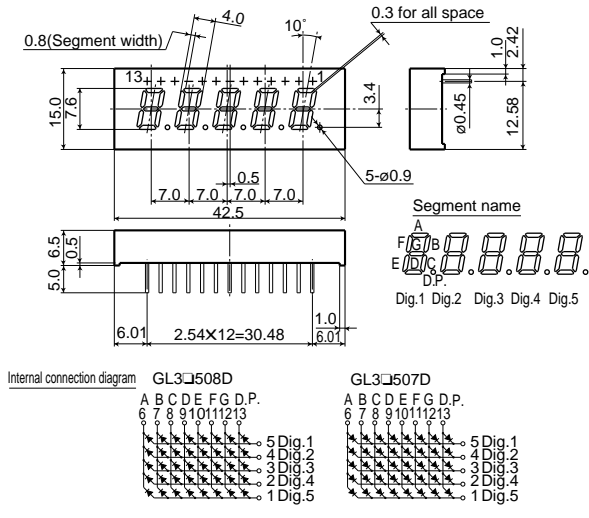

GL3□508D Series GL3□507D Series

(Notice) • In the absence of confirmation by device specification sheets, SHARP takes no responsibility for any defects that may occur in equipment using any SHARP devices shown in catalogs, data books, etc. Contact SHARP in order to obtain the latest device specification sheets before using any SHARP device.
 (Internet) • Data for sharp's optoelectronic/power device is provided for internet.(Address <http://www.sharp.co.jp/ecg/>)