

# GL380/GL381

## High Output, $\phi$ 3mm Resin Mold Type Infrared Emitting Diode

### ■ Features

- High output  
( $I_E$  : MIN. 4.5mW/sr at  $I_F = 50\text{mA}$ , **GL380**)  
( $I_E$  : MIN. 8.5mW/sr at  $I_F = 50\text{mA}$ , **GL381**)
- Compact  $\phi$  3mm resin mold package
- Narrow beam angle(  $\Delta\theta$  : TYP.  $\pm 13^\circ$  )

### ■ Applications

- Floppy disk drives
- Optoelectronic switches
- Infrared applied systems

### ■ Absolute Maximum Ratings (Ta = 25°C)

Parameter	Symbol	Rating	Unit
Forward current	$I_F$	60	mA
*1 Peak forward current	$I_{FM}$	1	A
Reverse voltage	$V_R$	6	V
Power dissipation	P	150	mW
Operating temperature	$T_{opr}$	- 25 to + 85	°C
Storage temperature	$T_{stg}$	- 40 to + 85	°C
*2 Soldering temperature	$T_{sol}$	260	°C

\*1 Pulse width  $\leq 100\mu\text{s}$ , Duty ratio = 0.01

\*2 For 3 seconds at the position of 2.6mm from the bottom face of resin package.

### ■ Electro-optical Characteristics (Ta = 25°C)

Parameter	Symbol	Conditions	MIN.	TYP.	MAX.	Unit
Forward voltage	$V_F$	$I_F = 50\text{mA}$	-	1.3	1.5	V
Peak forward voltage	$V_{FM}$	$I_{FM} = 0.5\text{A}$	-	2.2	3.5	V
Reverse current	$I_R$	$V_R = 3\text{V}$	-	-	10	$\mu\text{A}$
*3 Radiant intensity	<b>GL380</b>	$I_F = 50\text{mA}$	4.5	11	-	mW/sr
	<b>GL381</b>		8.5	20	-	
Peak emission wavelength	$\lambda_P$	$I_F = 5\text{mA}$	-	950	-	nm
Half intensity wavelength	$\Delta\lambda$	$I_F = 5\text{mA}$	-	45	-	nm
Terminal capacitance	$C_t$	$V_R = 0, f = 1\text{MHz}$	-	70	-	pF
Response frequency	$f_C$		-	300	-	kHz
Half intensity angle	$\Delta\theta$	$I_F = 20\text{mA}$	-	$\pm 13$	-	°

\*3  $I_E$  : Value obtained by converting the value in power of radiant fluxes at the solid angle of 0.01 sr (steradian) the direction of mechanical axis of the lens portion into 1 sr of all those emitted from the light emitting diode.

### ■ Outline Dimensions (Unit : mm)

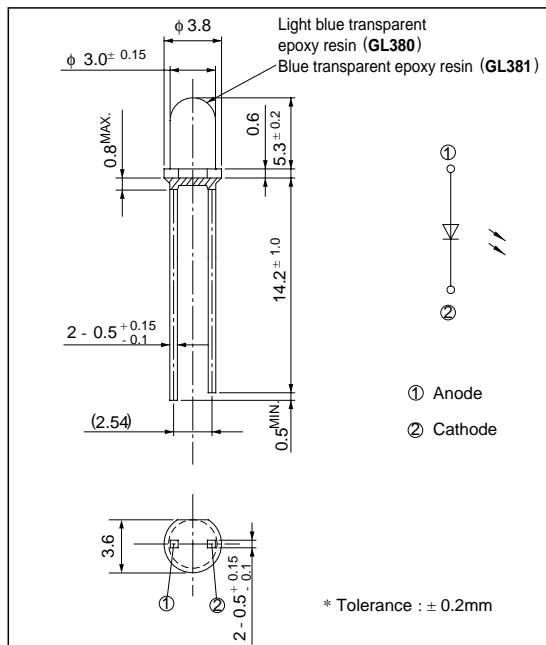

**Fig. 1 Forward Current vs. Ambient Temperature**

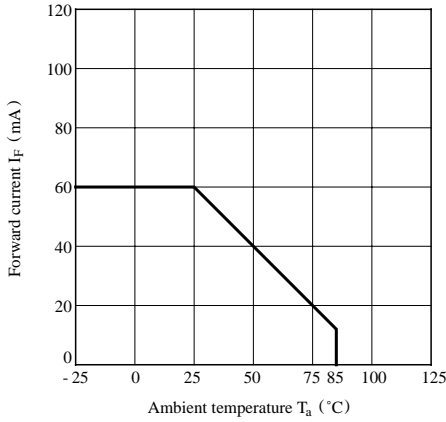

**Fig. 2 Peak Forward Current vs. Duty Ratio**

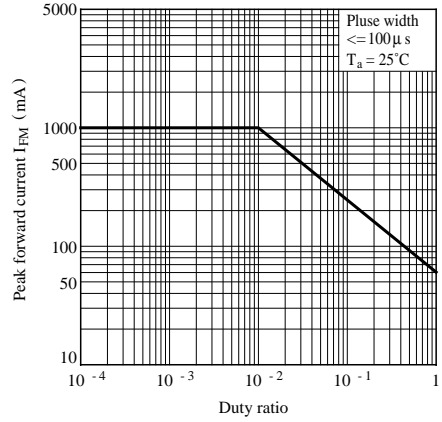

**Fig. 3 Spectral Distribution**

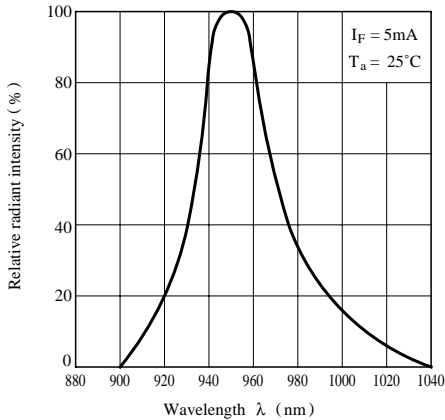

**Fig. 4 Peak Emission Wavelength vs. Ambient Temperature**

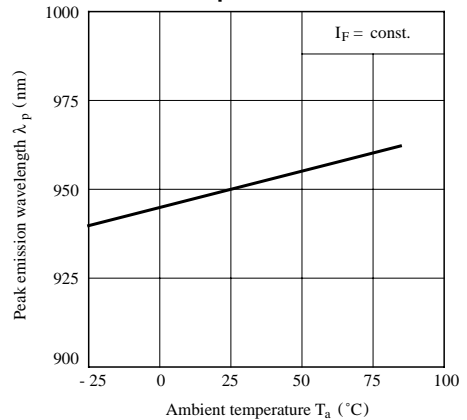

**Fig. 5 Forward Current vs. Forward Voltage**

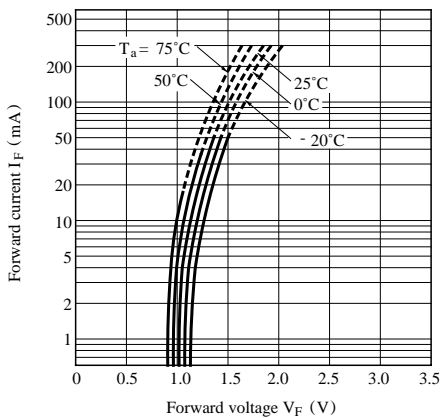

**Fig. 6 Relative Radiant Flux vs. Ambient Temperature**

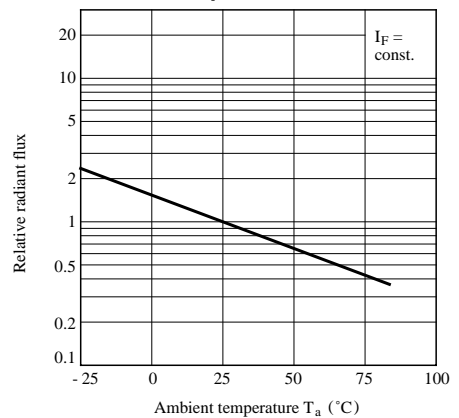

**Fig. 7 Radiant Intensity vs. Forward Current**

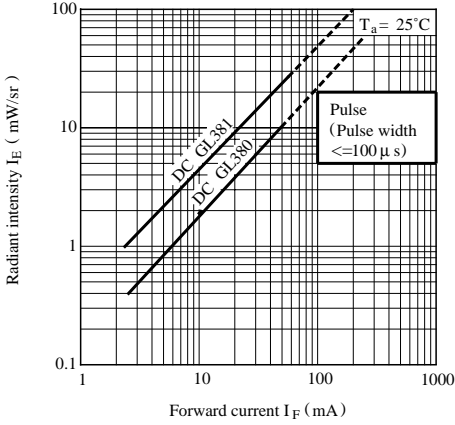

**Fig. 8 Relative Collector Current vs. Distance**  
(Detector : PT380 / PT381)

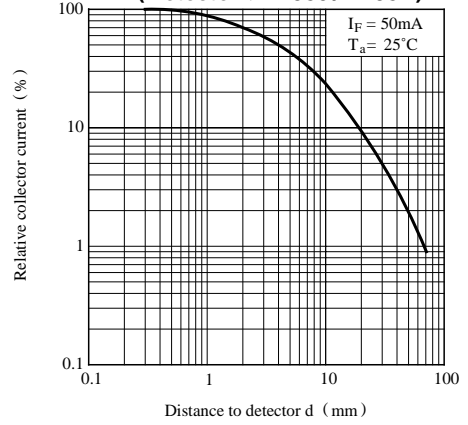

**Fig. 9 Radiation Diagram**

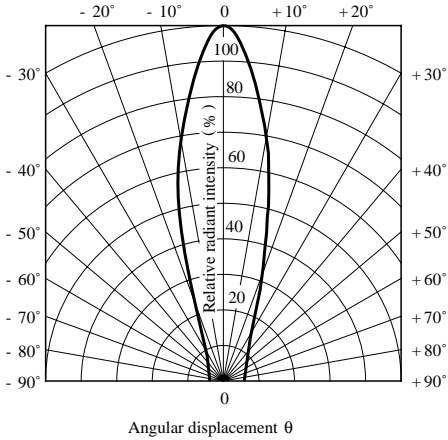

● Please refer to the chapter “Precautions for Use”