

Low-Dropout, 500mA Linear Regulator with Reset

Features

- 500mA Output Current, with Foldback Current Limiting
- High Ripple Rejection
- $\pm 2\%$ Output Accuracy
- $\pm 2\%$ Reset Threshold Accuracy
- Externally Programmable Reset Time Delay Generator
- Internal 500mA P-Channel Pass Transistor
- 320 μ A quiescent Current
- Thermal Overload Protection
- SOT89-5 Package

Applications

- CD ROM or DVD ROM
- Slim-Type CD/DVD
- DVD Player

General Description

The G9612 are low-dropout, linear regulator with reset function supply 3.4V, 3.3V or 2.5V output for currents up to 500mA. They are available in a 1.0W SOT 89-5L package with 0.18 inch² copper heat sink. Typical dropouts are 560mV at 5V and 500mA. Other features include foldback current limiting and thermal overload protection.

The reset function in G9612 detect V_{CC} level with hysteresis, keeping it asserted for time delay determined by external capacitor. The reset output is active low open-drain output. The detection threshold are 3.9V or 4.2V.

The output is preset at 3.4V for the G9612A, 3.3V for the G9612B/C, and 2.5V for G9612D. The reset threshold is preset at 4.2V for G9612 A/B/D and 3.9V for G9612C.

Ordering Information

ORDER NUMBER	ORDER NUMBER (Pb free)	MARKING	REGULATOR OUTPUT VOLTAGE	RESET THRESHOLD VOLTAGE	TEMP. RANGE	PACKAGE
G9612ATEU	G9612ATEUf	9612AX	3.4	4.2	-40°C to +85°C	SOT-89-5
G9612BTEU	G9612BTEUf	9612BX	3.3	4.2	-40°C to +85°C	SOT-89-5
G9612CTEU	G9612CTEUf	9612CX	3.3	3.9	-40°C to +85°C	SOT-89-5
G9612DTEU	G9612DTEUf	9612DX	2.5	4.2	-40°C to +85°C	SOT-89-5

Pin Configuration

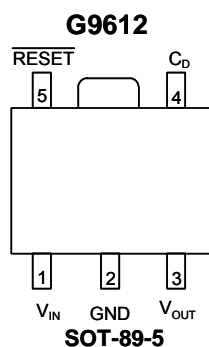

Typical Operation Circuit

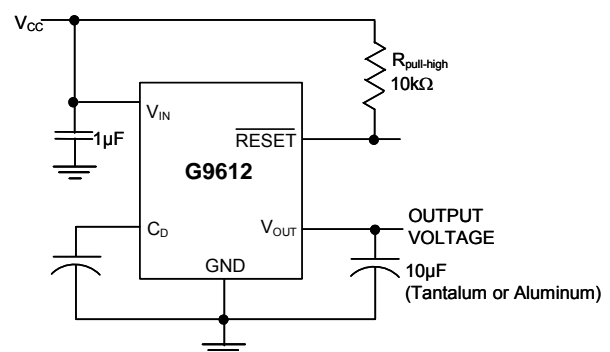

Absolute Maximum Ratings

Supply Voltage (IN or OUT to GND).....0.3V to 6.5V
 Input Voltage.....6.5V
 Thermal Resistance Junction to Ambient, (θ_{JA})
 SOT-89-5.....135°C/W
 Thermal Resistance Junction to Case, (θ_{JC})
 SOT-89-5.....24°C/W

Output Short-Circuit Duration.....1 min
 Operating Temperature Range.....-40°C to 85°C
 Junction Temperature.....160°C
 Storage Temperature Range.....-65°C to 160°C
 Reflow Temperature (soldering, 10sec).....260°C

Stresses beyond those listed under "Absolute Maximum Ratings" may cause permanent damage to the device. These are stress ratings only, and functional operation of the device at these or any other conditions beyond those indicated in the operational sections of the specifications is not implied. Exposure to absolute maximum rating conditions for extended periods may affect device reliability

Electrical Characteristics

$V_{IN}=5V$, $C_{IN}=1\mu F$, $C_{OUT}=10\mu F$, $T_J=T_A=25^\circ C$ (Note3), unless otherwise noted. Typical values for regulators are at $V_{IN}=5V$.

PARAMETER	SYMBOL	CONDITION	MIN	TYP	MAX	UNIT	
Input Voltage	V_{IN}		2.5	---	6.0	V	
Output Voltage (Note 1)	V_{OUT}	G9612A	3.332	3.4	3.468	V	
		G9612B/C	3.234	3.3	3.366		
		G9612D	2.45	2.5	2.55		
Load Regulation	ΔV_{LDR}	$I_{OUT}=1mA$ to 500mA, $V_{IN}=V_{OUT}+1V$	---	8	17	mV	
Line Regulation	ΔV_{LNR}	$(V_{OUT}+0.5V) \leq V_{IN} \leq 6V$, $I_{OUT}=25mA$	-8	0.3	8	mV	
Dropout Voltage (Note 2)	ΔV_{DO}	$I_{OUT}=500mA$	G9612A/B/C	---	560	610	mV
			G9612D	---	650	700	
Parameter Tempco V_{OUT}			---	40	---	ppm/°C	
Ripple Rejection	PSRR	$f=120Hz$, $I_{OUT}=30mA$	---	70	---	dB	
		$f=120Hz$, $I_{OUT}=300mA$	---	65	---		
Output Noise	e_n	20Hz to 100kHz, $I_{OUT}=30mA \sim 500mA$.	---	320	---	μV_{RMS}	
Quiescent Current	I_Q		---	320	450	μA	
Foldback Current Limit	I_{LIM}	$V_{OUT} < V_{FOLDBACK}$	260	400	580	mA	
		$V_{OUT} > V_{FOLDBACK}$	650	900	1200		
Foldback Voltage	$V_{FOLDBACK}$		0.6	0.78	0.95	V	
Thermal Shutdown Temperature	T_{SD}		---	160	---	°C	
Thermal Shutdown Hysteresis	ΔT_{SD}		---	30	---	°C	
Reset Threshold	V_{TH}	G9612A/B/D	4.11	4.2	4.29	V	
		G9612C	3.81	3.9	3.99		
Reset Threshold Hysteresis	V_{HYS}	G9612A/B/D	---	150	---	mV	
		G9612C	---	130	---		
Reset Threshold Tempco			---	40	---	ppm/°C	
C_D Delay Pin Threshold Voltage	V_{TCD}	$V_{CC}=5V$	3.5	3.9	4.3	V	
C_D Pin Sink Current	I_{CD}	$V_{CC}=1.5V$, $V_{CD}=0.5V$	3	4.3	---	mA	
C_D Pin Pullup Resistance	R_D		100	200	400	k Ω	
RESET Output Current Low	I_{OL}	$V_{CC}=2.5V$, $V_{RESET}=0.4V$	8	11.5	---	mA	
RESET Function Operating Voltage	V_{OP}	RESET sink current > 10 μA	---	0.7	0.85	V	

Note 1: ($V_{IN}-V_{OUT}$) is limited to keep the product ($I_{OUT} \times (V_{IN} - V_{OUT})$) from exceeding the package power dissipation limits.

Note 2: Dropout Voltage is ($V_{IN} - V_{OUT}$) when V_{OUT} falls to 100mV below its nominal value at $V_{IN} = V_{OUT}+1V$. For example, the G9612 is tested by measuring the V_{OUT} at $V_{IN} = V_{OUT}+1V$, then V_{IN} is lowered until V_{OUT} falls 100mV below the measured value. The difference ($V_{IN} - V_{OUT}$) is then measured and defined as ΔV_{DO} .

Note 3: Low duty pulse techniques are used during test to maintain junction temperature as close to ambient as possible.

Typical Performance Characteristics

($V_{IN}=5V$, $C_{IN}=C_{OUT}=10\mu F$, $CONT=V_{IN}$, $T_J=25^\circ C$, unless otherwise noted)

CONT Pin vs. Output

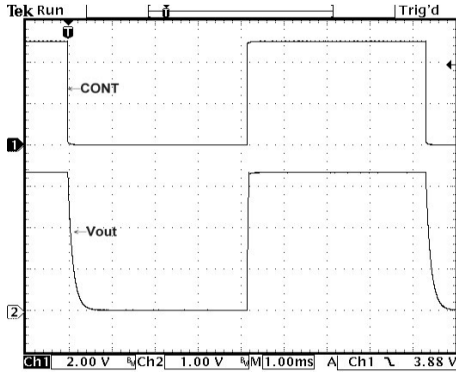

Load transient

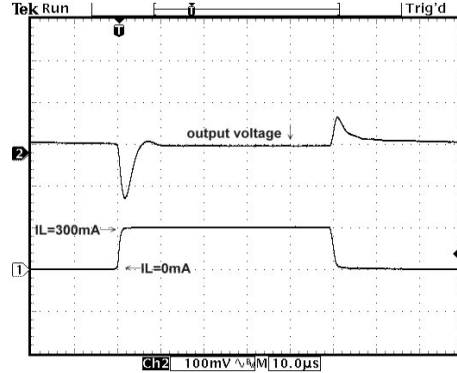

Load transient

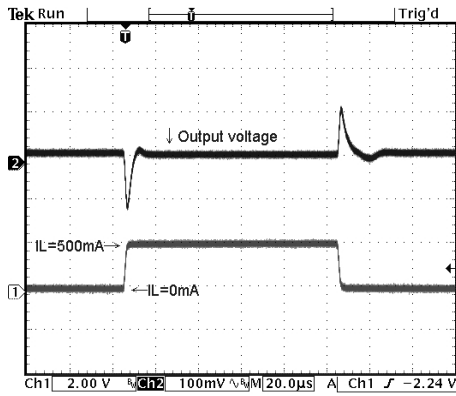

Line Transient

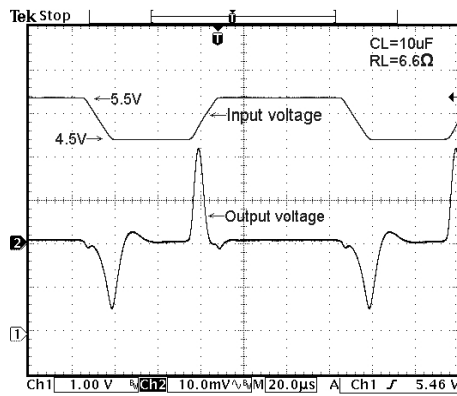

Line Transient

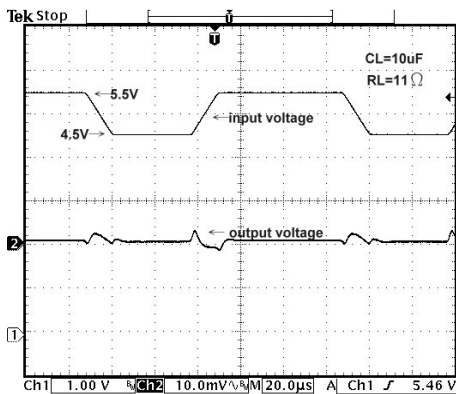

Line Transient

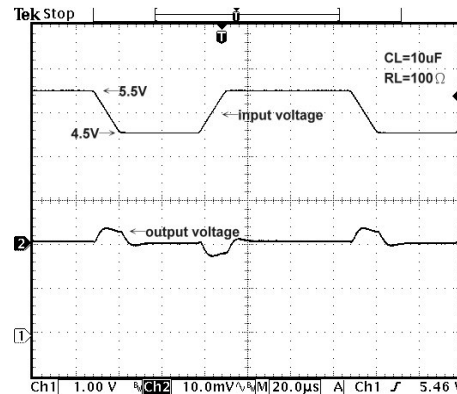



Typical Performance Characteristics (continued)

Over Current Response

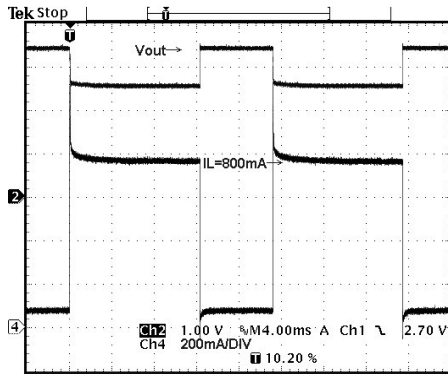

Short Circuit Response

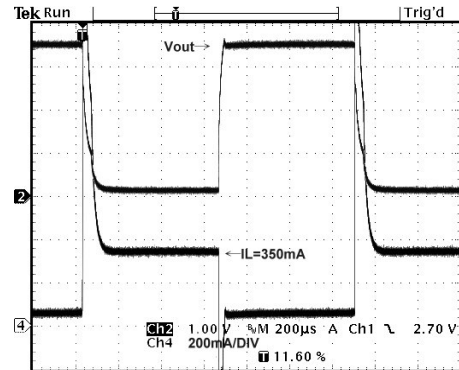

Power Supply Rejection Ratio

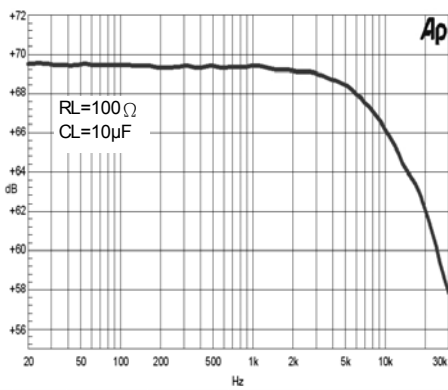

Power Supply Rejection Ratio

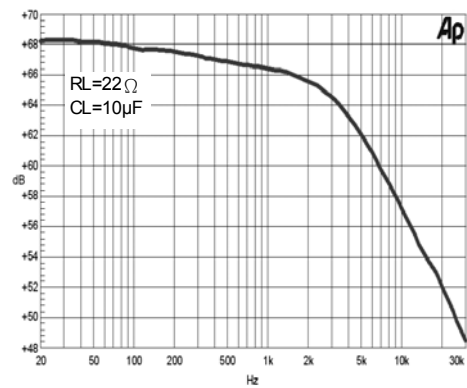

Power Supply Rejection Ratio

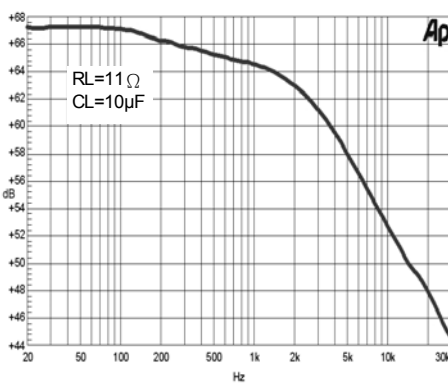

Power Supply Rejection Ratio

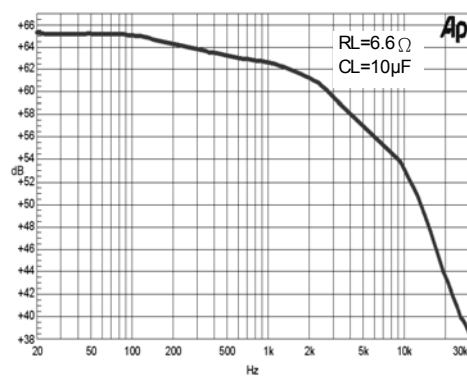

Typical Performance Characteristics (continued)

Max. Power Dissipation vs. PCB Top Copper Area
 $T_{AMB} = 25^{\circ}\text{C}$; Still Air

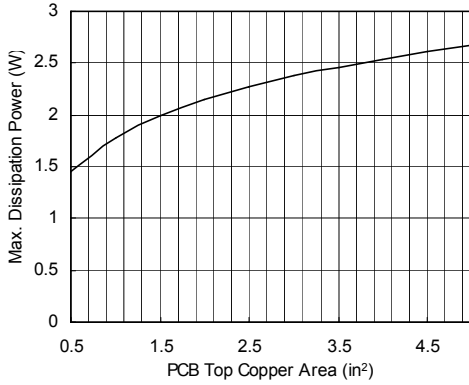

Max. Power Dissipation vs. T_{AMB} (still air)
 (Different PCB Top Copper Area)

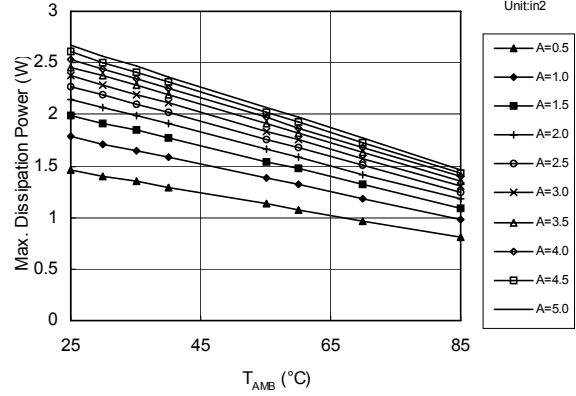

Recommended Minimum Footprint

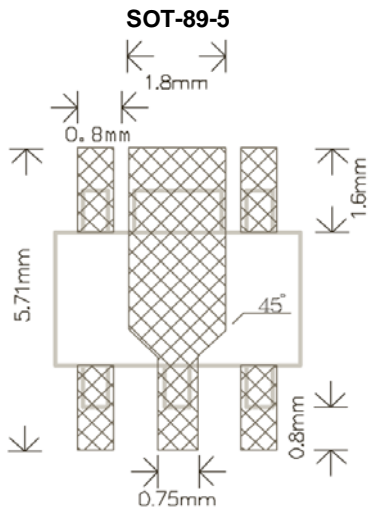

Pin Description

PIN NO.	PIN NAME	PIN FUNCTION
1	V_{IN}	Regulator Input. Supply voltage can range from 2.5V to 6V.
2	GND	Ground
3	V_{OUT}	Regulator Output. Sources up to 500mA.
4	C_D	External Programmable time delay is set by the capacitor connect to C_D pin.
5	\overline{RESET}	\overline{RESET} Open-Drain Output remains low while V_{IN} is below the reset threshold, and for delay time set by C_D after V_{IN} rises above the reset threshold.

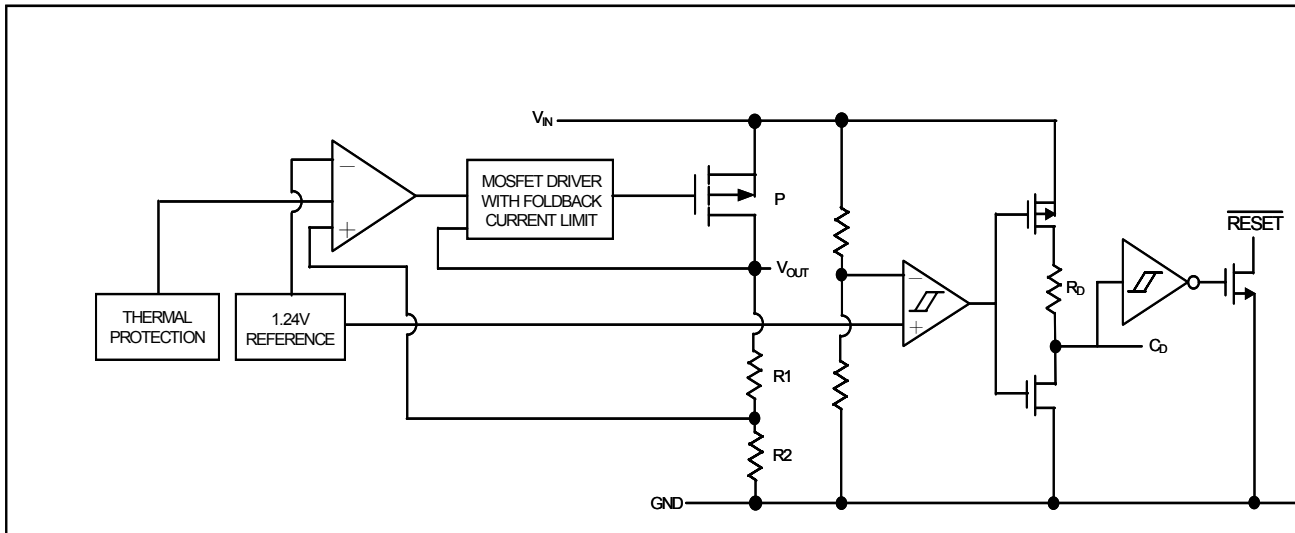

Figure 1. Functional Diagram

Detailed Description

The G9612 are low-dropout, low-quiescent current linear regulators with reset function. The regulator in G9612 supply 3.4V, 3.3V or 2.5V output for load currents up to 500mA. The reset function detect V_{IN} . As illustrated in Figure 1, they consist of a 1.24V reference, error amplifier, MOSFET driver, P-channel pass transistor, and internal feedback voltage divider, reset threshold comparator and time delay generator.

The 1.24V bandgap reference is connected to the error amplifier's inverting input. The error amplifier compares this reference with the feedback voltage and amplifies the difference. The MOSFET driver reads the error signal and applies the appropriate drive to the P-channel pass transistor. If the feedback voltage is lower than the reference, the pass transistor gate is pulled lower, allowing more current to pass and increasing the output voltage. If the feedback voltage is too high, the pass transistor gate is pulled up, allowing less current to pass to the output.

Additional blocks of linear regulator include a foldback current limiter, reverse current protection, and thermal sensor.

The G9612 also offer reset function to detect the level of V_{IN} . They assert a reset signal whenever V_{IN} supply voltage declines below a preset threshold (V_{TH}), keeping it asserted for time delay set by capacitor connected to C_D pin, after V_{IN} has risen above the high reset threshold ($V_{TH} + V_{HYS}$). The \overline{RESET} is an active low, open-drain output.

Internal P-Channel Pass Transistor

The G9612 feature a 500mA P-channel MOSFET pass transistor. This provides several advantages over similar designs using PNP pass transistors, including longer battery life. The P-channel MOSFET requires no base drive, which reduces quiescent current considerably. PNP based regulators waste considerable amounts of current in dropout when the pass transistor saturates. They also use high base-drive currents under large loads. The G9612 do not suffer from these problems and consume only 320 μ A of quiescent current.

Foldback Current Limiting

The G9612 also include a foldback current limiter. It monitors and controls the pass transistor's gate voltage, estimating the output current and limiting it to 900mA for output voltages above 0.78V. If the output voltage drops below 0.78V, implying a short-circuit condition, the output current is limited to 400mA.

Thermal Overload Protection

Thermal overload protection limits total power dissipation in the G9612. When the junction temperature exceeds $T_J = +160^\circ\text{C}$, the thermal sensor sends a signal to the shutdown logic, turning off the pass transistor and allowing the IC to cool. The thermal sensor will turn the pass transistor on again after the IC's junction temperature cools by 30°C , resulting in a pulsed output during thermal overload conditions.

Thermal overload protection is designed to protect the G9612 in the event of fault conditions. For continual operation, the absolute maximum junction temperature rating of $T_J = +160^\circ\text{C}$ should not be exceeded.

Operating Region and Power Dissipation

Maximum power dissipation of the G9612 depends on the thermal resistance of the case and circuit board, the temperature difference between the die junction and ambient air, and the rate of air flow. The power dissipation across the device is $P = I_{\text{OUT}} (V_{\text{IN}} - V_{\text{OUT}})$. The resulting maximum power dissipation is:

$$P_{\text{MAX}} = \left[\frac{(T_J - T_A)}{(\theta_{\text{JC}} + \theta_{\text{CA}})} \right]$$

where $(T_J - T_A)$ is the temperature difference between the G9612 die junction and the surrounding air, θ_{JC} is the thermal resistance of the package chosen, and θ_{CA} is the thermal resistance through the printed circuit board, copper traces and other materials to the surrounding air. The thermal resistance of SOT89-5 with 0.18 inch² copper heat sink is $\theta_{\text{JA}} = 125^\circ\text{C/W}$.

The power dissipation of G9612 is:

$$P_D = (V_{\text{IN}} - V_{\text{OUT}}) \times I_{\text{OUT}}$$

The worst-case thermal resistance from junction to air (θ_{JA}) requirements are:

$$\theta_{\text{JA}} = \frac{(150^\circ\text{C} - T_A)}{P_D}$$

Use larger copper pad area to obtain specific heat sink thermal resistance values for larger output current, higher input-output difference, and higher ambient temperature.

C_D Capacitor Selection

The reset timeout delay is set by internally pull-up R_D (typical value 200k Ω) and external C_D .

When the voltage at C_D pin exceeds the buffer threshold, typically $0.8 V_{\text{CC}}$, the $\overline{\text{RESET}}$ output high. The voltage detector and buffer have built-in hysteresis to prevent erratic reset operation. For $C_D = 0.1\mu\text{F}$, typical reset time delay is 30ms. The formula of delay time is:

$$T(\text{ms}) = 303 \times C_D(\mu\text{F})$$

Regulator Output Capacitor Selection and Regulator Stability

Normally, use capacitors 0.1 μF minimum on the input and 10 μF minimum on the output of the G9612. The larger input capacitor values provide better supply noise rejection and line-transient response. Improve load transient response, stability, and power-supply rejection by using large output capacitors. For stable operation over the full temperature range and with load current up to 500mA, 10 μF tantalum or 47 μF aluminum minimum is recommended. Too small capacitors with small ESR can result in oscillation.

Transient Considerations

The Typical Operating Characteristics show the G9612 load-transient response. Two components of the output response can be observed on the load-transient graphs—a DC shift from the output impedance due to the different load currents, and the transient response. Typical transients for step changes in the load current from 5mA to 500mA are 0.1V. Increasing the output capacitor's value attenuates transient spikes.

Package Information

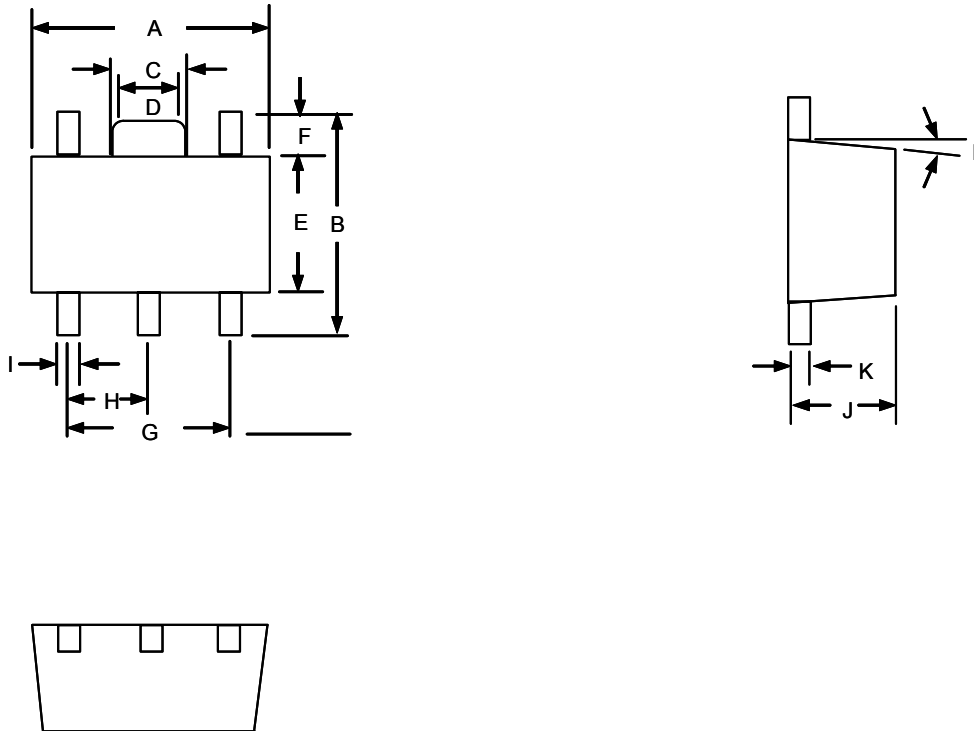

SYMBOL	DIMENSION IN MM		DIMENSION IN INCH	
	MIN.	MAX.	MIN.	MAX.
A	4.40	4.60	0.173	0.181
B	4.05	4.25	0.159	0.167
C	1.50	1.70	0.059	0.067
D	1.30	1.50	0.051	0.059
E	2.40	2.60	0.094	0.102
F	0.80	-----	0.031	-----
G	3.00 REF		0.118 REF	
H	1.50 REF		0.059 REF	
I	0.40	0.52	0.016	0.020
J	1.40	1.60	0.055	0.063
K	0.35	0.41	0.014	0.016
L	5° TYP		5° TYP	

Taping Specification

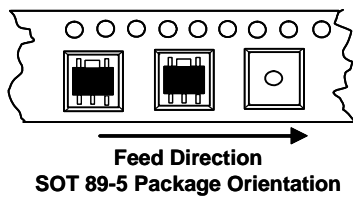

PACKAGE	Q'TY/REEL
SOT-89-5	1,000 ea

GMT Inc. does not assume any responsibility for use of any circuitry described, no circuit patent licenses are implied and GMT Inc. reserves the right at any time without notice to change said circuitry and specifications.