

## 2A Low Dropout Regulator

### Features

- Fixed Output Voltage 1.2V, 1.5V, 1.8V and 2.5V
- Over Current and Over Temperature Protection
- Output Current 2A
- TO-263 & TO-263T Package

### Applications

- Battery Powered Systems
- Motherboards
- Peripheral Cards
- Network Cards
- Set Top Boxes
- Notebook Computers

### General Description

The G954 is a high performance positive voltage regulator designed for use in applications requiring very low dropout voltage at up to 2 Amps. Since it has superior dropout characteristics compared with regular LDOs, it can be used to supply 2.5V on motherboards or 1.5V, 1.8V on peripheral cards from the power supply thus allowing the elimination of costly heatsinks. The G954 provides excellent regulation over variations in line, load and temperature. It provides over current and over temperature protection functions.

The G954 is available with 1.2V, 1.5V, 1.8V, 2.5V and adjustable outputs in TO-263 & TO-263T package.

ORDER NUMBER	MARKING	VOLTAGE	TEMP. RANGE	PACKAGE (Pb free)
G954-12T55U	G954-12	1.2V	-40°C ~ +85°C	TO-263
G954-15T55U	G954-15	1.5V	-40°C ~ +85°C	TO-263
G954-18T55U	G954-18	1.8V	-40°C ~ +85°C	TO-263
G954-25T55U	G954-25	2.5V	-40°C ~ +85°C	TO-263
G954-12TU5U	G954-12	1.2V	-40°C ~ +85°C	TO-263T
G954-15TU5U	G954-15	1.5V	-40°C ~ +85°C	TO-263T
G954-18TU5U	G954-18	1.8V	-40°C ~ +85°C	TO-263T
G954-25TU5U	G954-25	2.5V	-40°C ~ +85°C	TO-263T

Note: T5: TO-263    TU: TO-263T  
 5: Bonding Code  
 U: Tape & Reel

### Pin Configuration

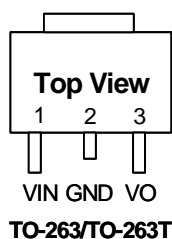

### Typical Application Circuit

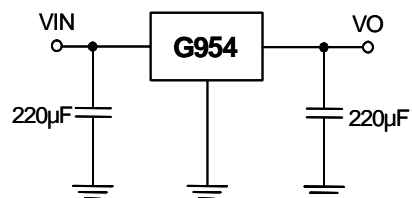

**Absolute Maximum Ratings** (Note 1)

Input Voltage	7V
Power Dissipation Internally Limited	(Note 2)
Maximum Junction Temperature	150°C
Storage Temperature Range	-65°C ≤ T <sub>J</sub> ≤ +150°C
Reflow Temperature (soldering, 10sec)	260°C
Thermal Resistance Junction to Ambient, (θ <sub>JA</sub> )	
TO-263T <sup>(1)</sup>	80°C/W
Thermal Resistance Junction to Case, (θ <sub>Jc</sub> )	
TO-263T	8°C/W
ESD Rating (Human Body Model)	2kV

**Operation Conditions** (Note 1)

Input Voltage	2.2V ~5.5V
Temperature Range	-40°C ≤ T <sub>A</sub> ≤ +85°C

Note <sup>(1)</sup>: See Recommended Minimum Footprint

**Electrical Characteristics**

V<sub>IN</sub> = 5V, I<sub>O</sub> = 0.5A, C<sub>IN</sub> = C<sub>OUT</sub> = 220μF, T<sub>A</sub> = T<sub>J</sub> = 25°C unless otherwise specified (Note 3)

PARAMETER	SYMBOL	CONDITION	MIN	TYP	MAX	UNIT
Supply Voltage	V <sub>IN</sub>		2.2	---	5.5	V
Output Voltage	V <sub>O</sub>	V <sub>IN</sub> = V <sub>O</sub> + 0.7V, I <sub>O</sub> = 10mA	-2	V <sub>O</sub>	2	%
Line Regulation		V <sub>O</sub> + 0.7V ≤ V <sub>IN</sub> ≤ 5.5V, I <sub>O</sub> = 10mA	---	0.2	2	%
Load Regulation		G954-12 V <sub>IN</sub> = 2.5V, 10mA ≤ I <sub>OUT</sub> ≤ 2A	---	1	2	%
		G954-15 V <sub>IN</sub> = 2.5V, 10mA ≤ I <sub>OUT</sub> ≤ 2A				
		G954-18 V <sub>IN</sub> = 3.8V, 10mA ≤ I <sub>OUT</sub> ≤ 2A				
		G954-25 V <sub>IN</sub> = 5V, 10mA ≤ I <sub>OUT</sub> ≤ 2A				
Quiescent Current	I <sub>Q</sub>	V <sub>IN</sub> = 5V	---	2.7	4.5	mA
Ripple Rejection		f <sub>i</sub> = 120Hz, 1V <sub>P-P</sub> , I <sub>O</sub> = 100mA	---	55	---	dB
Dropout Voltage	V <sub>D</sub>	G954-15 ΔV <sub>OUT</sub> = 2%, I <sub>OUT</sub> = 2A	---	0.9	1.1	V
		G954-18 ΔV <sub>OUT</sub> = 2%, I <sub>OUT</sub> = 2A	---	0.7	0.9	
		G954-25 ΔV <sub>OUT</sub> = 2%, I <sub>OUT</sub> = 2A	---	0.5	0.7	
Short Circuit Current			---	1	---	A
Over Temperature			---	150	---	°C

**Note 1:** Absolute Maximum Ratings are limits beyond which damage to the device may occur. Operating Conditions are conditions under which the device functions but the specifications might not be guaranteed. For guaranteed specifications and test conditions see the Electrical Characteristics.

**Note2:** The maximum power dissipation is a function of the maximum junction temperature, T<sub>Jmax</sub>; total thermal resistance, θ<sub>JA</sub>, and ambient temperature T<sub>A</sub>. The maximum allowable power dissipation at any ambient temperature is (T<sub>Jmax</sub>-T<sub>A</sub>)/θ<sub>JA</sub>. If this dissipation is exceeded, the die temperature will rise above 150°C and IC will go into thermal shutdown.

**Note3:** Low duty pulse techniques are used during test to maintain junction temperature as close to ambient as possible.



---

## Definitions

### Dropout Voltage

The input/output voltage differential at which the regulator output no longer maintains regulation against further reductions in input voltage. Measured when the output drops 2% below its nominal value, dropout voltage is affected by junction temperature, load current and minimum input supply requirements.

### Line Regulation

The change in output voltage for a change in input voltage. The measurement is made under conditions of low dissipation or by using pulse techniques such that average chip temperature is not significantly affected.

### Load Regulation

The change in output voltage for a change in load current at constant chip temperature. The measurement is made under conditions of low dissipation or by using pulse techniques such that average chip temperature is not significantly affected.

### Maximum Power Dissipation

The maximum total device dissipation for which the regulator will operate within specifications.

### Quiescent Bias Current

Current which is used to operate the regulator chip and is not delivered to the load.

**Typical Performance Characteristics**

$V_{IN}-V_{OUT}=3V$ ,  $C_{IN}=220\mu F$ ,  $C_{OUT}=220\mu F$ ,  $T_A=25^\circ C$ , unless otherwise noted.

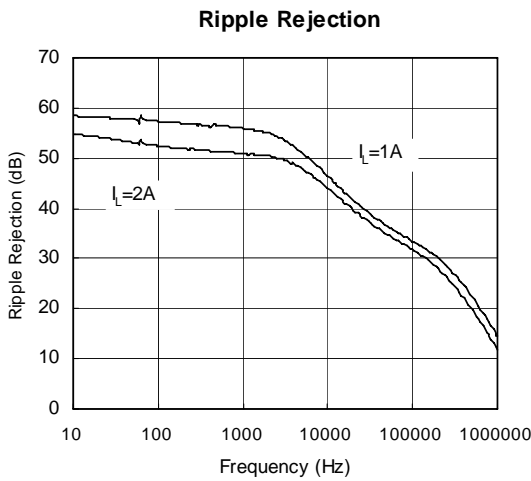
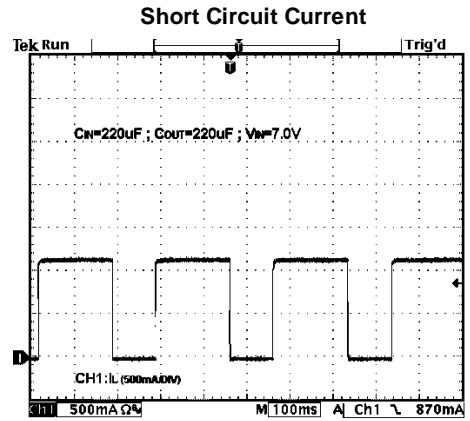
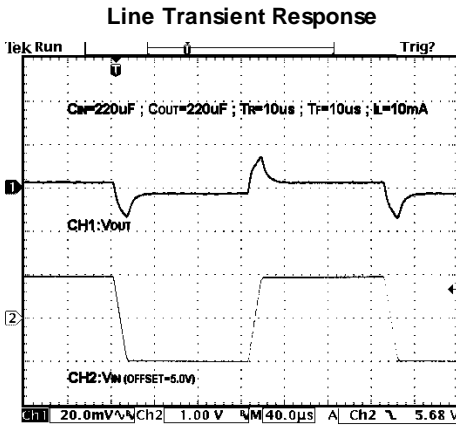

**G954-18 Overcurrent Protection Characteristics**

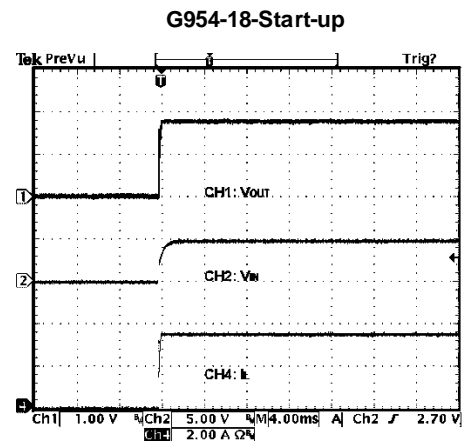
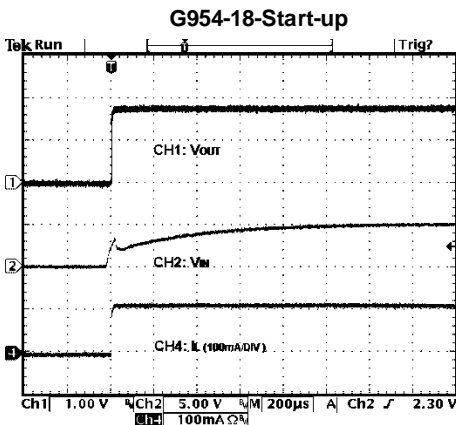
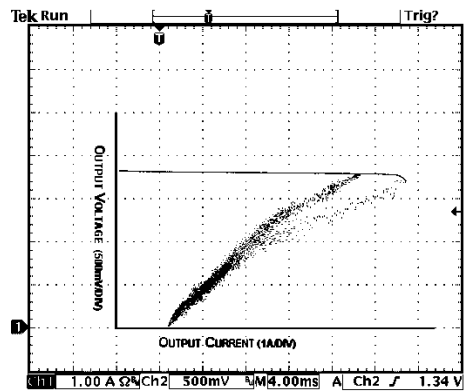

Typical Performance Characteristics (continued)

**Max. Power Dissipation vs. PCB Top Copper Area**

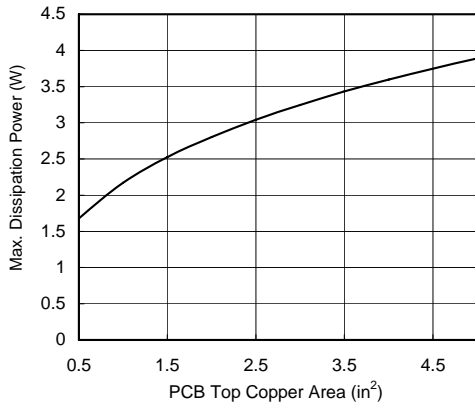

**Max. Power Dissipation vs. T<sub>AMB</sub>**

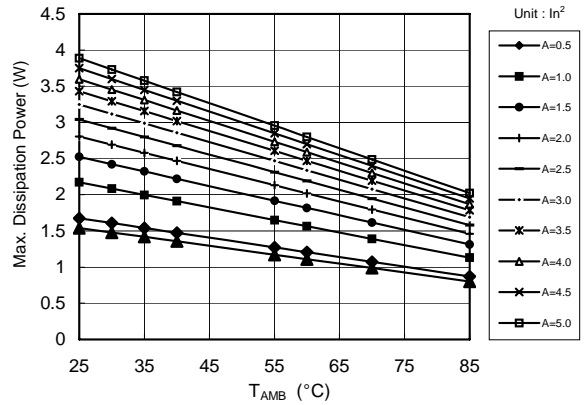

**G954-18 Quiescent Current vs. Temperature**

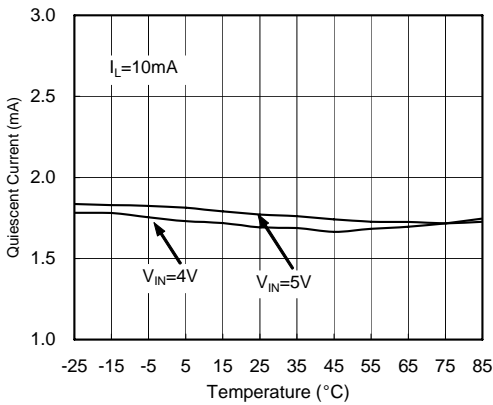

**G954-18 Dropout Voltage vs. I<sub>L</sub>**

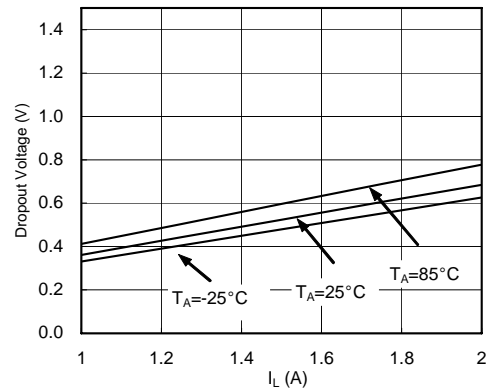

**G954-18 Output Voltage vs. Temperature**

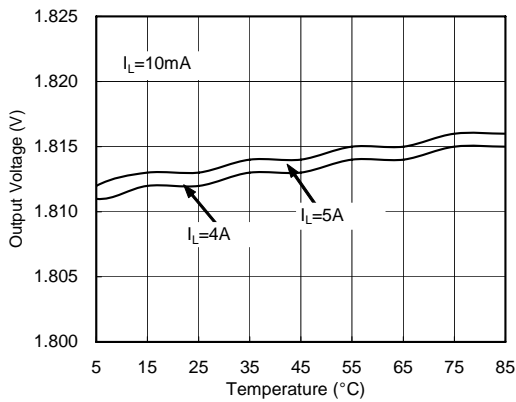

**G954-18 Output Voltage vs. I<sub>L</sub>**

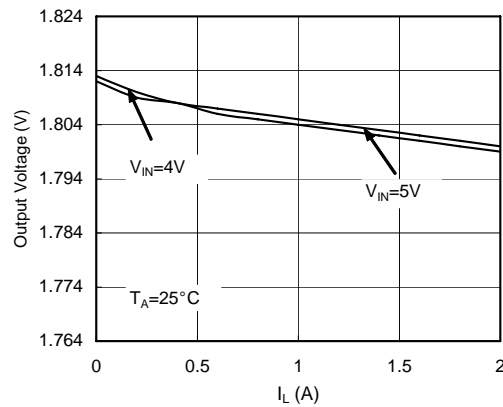

Typical Performance Characteristics (continued)

**G954-25 Quiescent Current vs. Temperature**

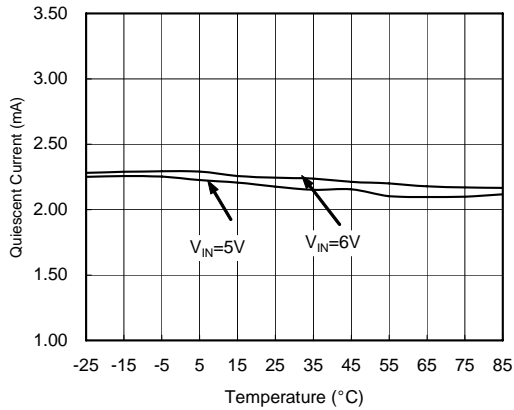

**G954-25 Dropout Voltage vs.  $I_L$**

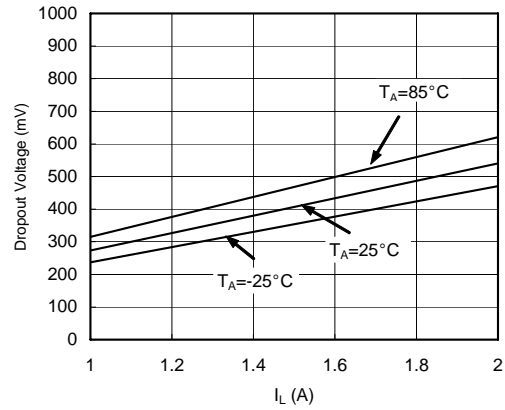

**G954-25 Output Voltage vs. Temperature**

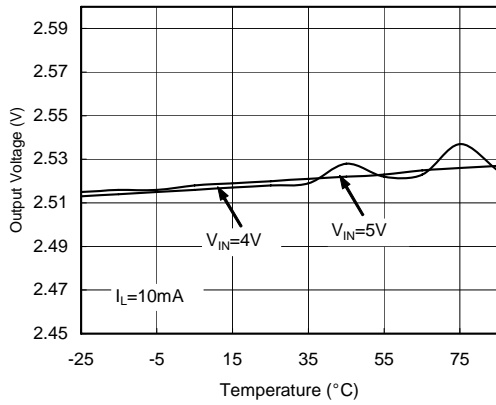

**G954-25 Output Voltage vs.  $I_L$**

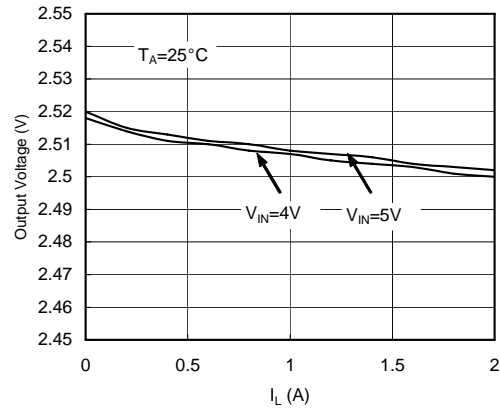

**Recommended Minimum Footprint**

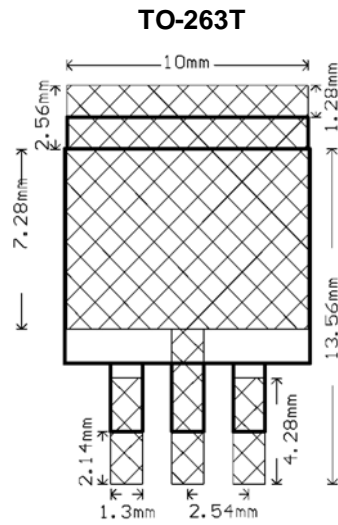
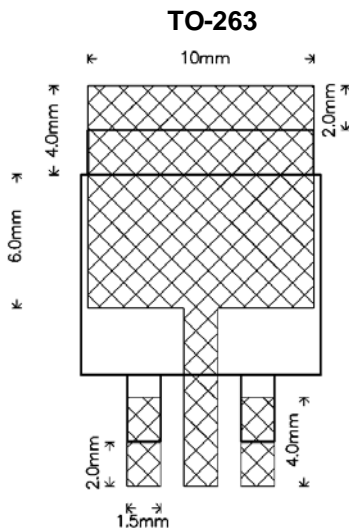

**Package Information**

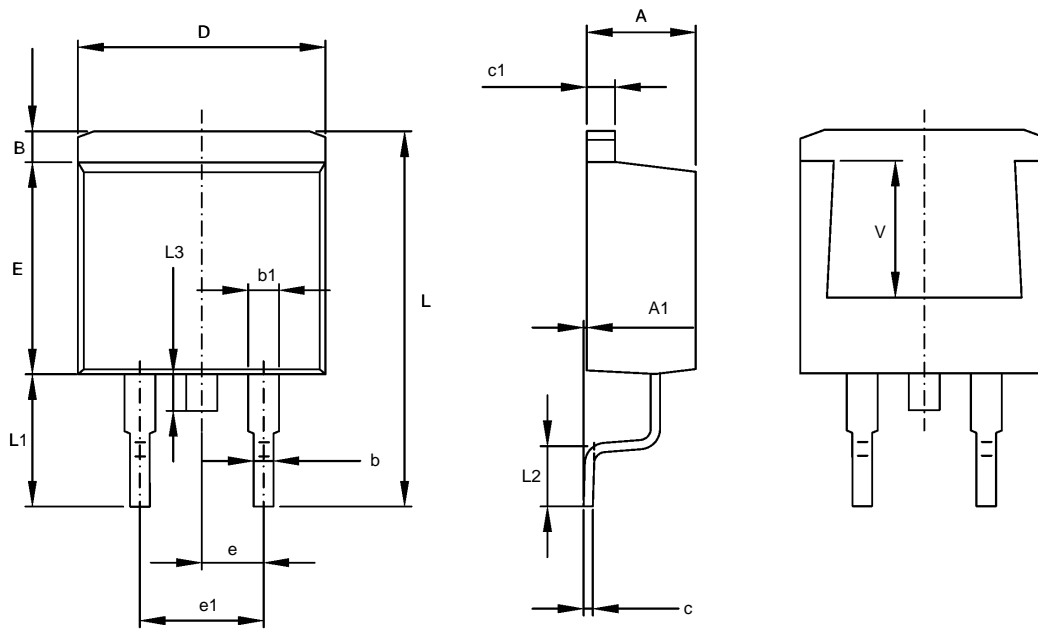

**TO-263 (T5) Package**

SYMBOL	MILLIMETER		INCH	
	MIN	MAX	MIN	MAX
A	4.470	4.670	0.176	0.184
A1	0.000	0.150	0.000	0.006
B	1.170	1.370	0.046	0.054
b	0.710	0.910	0.028	0.036
b1	1.170	1.370	0.046	0.054
c	0.310	0.530	0.012	0.021
c1	1.170	1.370	0.046	0.054
D	10.010	10.310	0.394	0.406
E	8.500	8.900	0.335	0.350
e	2.540 TYP		0.100 TYP	
e1	4.980	5.180	0.196	0.204
L	15.050	15.450	0.593	0.608
L1	5.080	5.480	0.200	0.216
L2	2.340	2.740	0.092	0.108
L3	1.300	1.700	0.051	0.067
V	5.600 REF		0.220 REF	

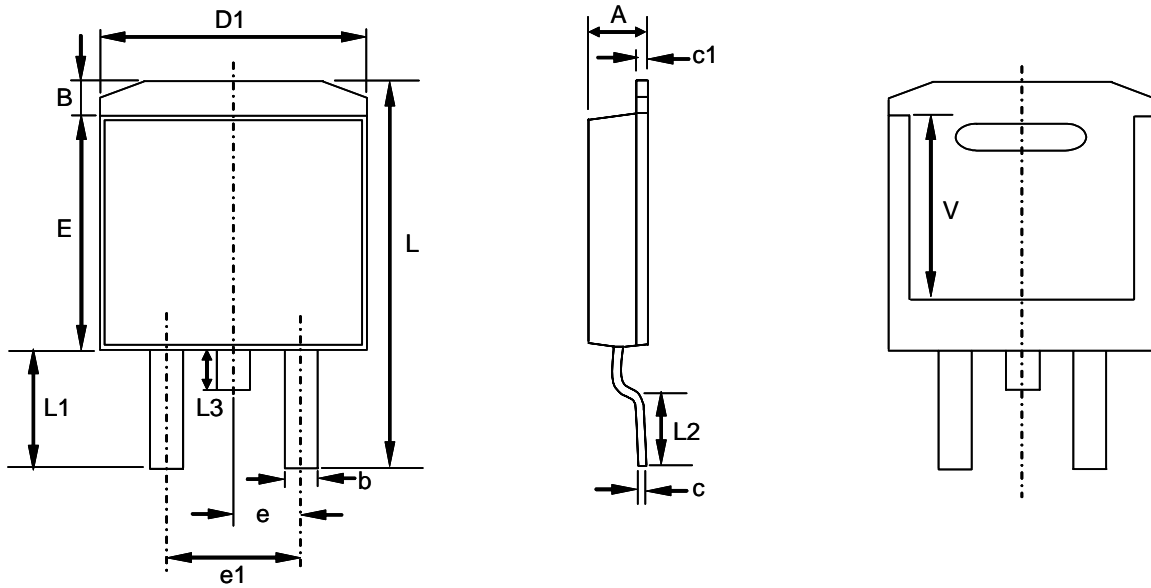

**TO-263T (TU) Package**

SYMBOL	DIMENSIONS IN MILLIMETER			DIMENSIONS IN INCH		
	MIN	NOM	MAX	MIN	NOM	MAX
A	1.750	2.000	2.250	0.069	0.079	0.089
B	0.880	1.280	1.680	0.345	0.050	0.066
b	1.255	1.295	1.335	0.049	0.051	0.053
c	0.381	0.406	0.431	0.015	0.016	0.017
c1	0.356	0.406	0.456	0.014	0.016	0.018
D	9.660	10.160	10.660	0.380	0.400	0.420
E	8.380	8.680	8.980	0.330	0.342	0.354
e	-----	2.540	-----	-----	0.100	-----
e1	-----	5.080	-----	-----	0.200	-----
L	13.74	14.240	14.740	0.541	0.561	0.580
L1	-----	4.280	-----	-----	0.169	-----
L2	2.290	2.540	2.790	0.090	0.100	0.110
L3	-----	-----	1.778	-----	-----	0.070
V	-----	7.280	-----	-----	0.287	-----

**Taping Specification**

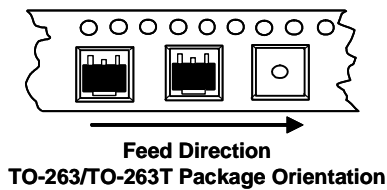

PACKAGE	Q'TY/REEL
TO-263	800 ea
TO-263T	1,500 ea

GMT Inc. does not assume any responsibility for use of any circuitry described, no circuit patent licenses are implied and GMT Inc. reserves the right at any time without notice to change said circuitry and specifications.