



# 1.8V 1A Regulator

## Features

- Output current in excess of 1A
- Output voltage accuracy +2.5%/-2%
- Quiescent current, typically 480 $\mu$ A
- Internal short circuit current limit
- Internal over temperature protection

## Applications

- PC motherboard
- ADSL/Cable Modem
- Set-Top-Box
- LAN switch/Hub
- Broad band access

## General Description

The G952 positive 1.8V voltage regulator features the ability to source 1A of output current. The typical quiescent current is 0.48mA.

Familiar regulator features such as over temperature and over current protection circuits are provided to prevent it from being damaged by abnormal operating conditions.

## Ordering Information

ORDER NUMBER	PACKAGE TYPE	PIN OPTION		
		1	2	3
G952T23U	SOT 89	GND	V <sub>OUT</sub>	V <sub>IN</sub>
G952T63U	SOT 223	GND	V <sub>OUT</sub>	V <sub>IN</sub>

\* For other package types and pin options, please contact us at sales @gmt.com.tw

## Order Number Identification

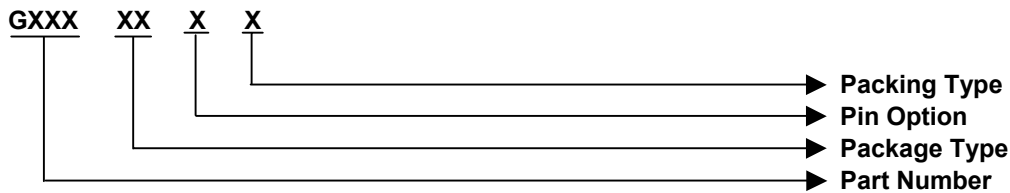

### PACKAGE TYPE

T2: SOT 89  
T3: TO 220  
T4: TO 252  
T5: TO 263  
T6: SOT 223

### PIN OPTION

1	2	3
1: V <sub>OUT</sub>	GND	V <sub>IN</sub>
2: V <sub>OUT</sub>	V <sub>IN</sub>	GND
3: GND	V <sub>OUT</sub>	V <sub>IN</sub>
4: GND	V <sub>IN</sub>	V <sub>OUT</sub>
5: V <sub>IN</sub>	GND	V <sub>OUT</sub>
6: V <sub>IN</sub>	V <sub>OUT</sub>	GND

### PACKING

U & D: Tape & Reel Direction  
T: Tube

## Typical Application

[Note 4]: Type of C<sub>OUT</sub>

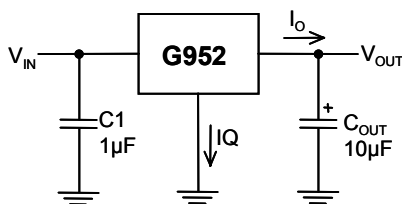

## Package Type

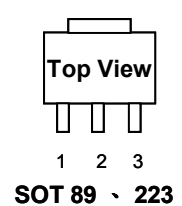
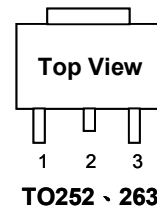
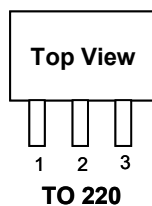



<b>Absolute Maximum Ratings</b>	(Note 1)
Input Voltage.....	7V
Power Dissipation Internally Limited.....	(Note 2)
Maximum Junction Temperature.....	150°C
Storage Temperature Range.....	-65°C ≤ T <sub>J</sub> ≤ +150°C
Lead Temperature, Time for Wave Soldering	
SOT 223 Package.....	260°C, 4s
Continuous Power Dissipation (T <sub>A</sub> = +25°C)	
SOT 89 <sup>(1)</sup> .....	0.5W
SOT 223 <sup>(1)</sup> .....	0.8W

<b>Operating Conditions</b>	(Note 1)
Input Voltage.....	2.7V~6.5V
Temperature Range.....	0°C ≤ T <sub>J</sub> ≤ 125°C

Note<sup>(1)</sup>: See Recommended Minimum Footprint

## Electrical Characteristics

V<sub>IN</sub> = 3.3V, I<sub>O</sub> = 1A, C<sub>IN</sub> = 1μF, C<sub>OUT</sub> = 10μF, All specifications apply for T<sub>A</sub> = T<sub>J</sub> = 25°C. [Note 3]

PARAMETER	CONDITIONS		MIN	TYP	MAX	UNITS
Output Voltage	10mA ≤ I <sub>O</sub> ≤ 1A		1.764	1.800	1.845	V
Line Regulation	3V ≤ V <sub>IN</sub> ≤ 6.5V, I <sub>O</sub> = 10mA			3	30	mV
Load Regulation	10mA ≤ I <sub>O</sub> ≤ 1A			30	50	mV
Output Impedance	200mA DC and 100mA AC, f <sub>o</sub> = 120Hz			80		mΩ
Quiescent Current	V <sub>IN</sub> = 3.3V			480		μA
Ripple Rejection	f <sub>i</sub> = 120Hz, V <sub>ripple</sub> = 1V <sub>P-P</sub> , I <sub>O</sub> = 100mA			53		dB
Dropout Voltage	I <sub>O</sub> = 0A			880		mV
	I <sub>O</sub> = 100mA			895		
	I <sub>O</sub> = 500mA			950		
	I <sub>O</sub> = 1A			1160		
Output Current	Continuous Test, T <sub>A</sub> = 25°C, T <sub>J</sub> 150°C, V <sub>OUT</sub> within ±2%	V <sub>IN</sub> = 3V(SOT 223)	Minimum footprint (0.0625 square inch)	660		mA
		V <sub>IN</sub> = 3.3V(SOT 223)	Mounted on 0.53 square inch pcb area	1		A
		V <sub>IN</sub> = 3.3V(SOT 89)	Mounted on 0.16 square inch pcb area	0.5		A
Short Circuit Current				1.6		A
Over Temperature				150		°C

**Note 1:** Absolute Maximum Ratings are limits beyond which damage to the device may occur. Operating Conditions are conditions under which the device functions but the specifications might not be guaranteed. For guaranteed specifications and test conditions see the Electrical Characteristics.

**Note2:** The maximum power dissipation is a function of the maximum junction temperature, T<sub>Jmax</sub>; total thermal resistance, θ<sub>JA</sub>, and ambient temperature T<sub>A</sub>. The maximum allowable power dissipation at any ambient temperature is T<sub>Jmax</sub>-T<sub>A</sub> / θ<sub>JA</sub>. If this dissipation is exceeded, the die temperature will rise above 150°C and IC will go into thermal shutdown. For the G952 in SOT 89 package, θ<sub>JA</sub> is 250°C/W For the G952 in SOT 223 package, θ<sub>JA</sub> is 156°C/W (See recommend minimum footprint). The safe operation in SOT 89, SOT 223 package, it can see "Typical Performance Characteristics" (Safe Operating Area).

**Note3:** Low duty pulse techniques are used during test to maintain junction temperature as close to ambient as possible.

**Note4:** The type of output capacitor should be tantalum or aluminum.

## Definitions

### Dropout Voltage

The input/output Voltage differential at which the regulator output no longer maintains regulation against further reductions in input voltage. Measured when the output drops 100mV below its nominal value. Dropout voltage is affected by junction temperature, load current and minimum input supply requirements.

### Line Regulation

The change in output voltage for a change in input voltage. The measurement is made under conditions of low dissipation or by using pulse techniques such that average chip temperature is not significantly affected.

### Load Regulation

The change in output voltage for a change in load current at constant chip temperature. The measurement is made under conditions of low dissipation or by using pulse techniques such that average chip temperature is not significantly affected.

### Maximum Power Dissipation

The maximum total device dissipation for which the regulator will operate within specifications.

### Quiescent Bias Current

Current which is used to operate the regulator chip and is not delivered to the load.



Typical Performance Characteristics

(VIN= +3.3V, CIN=1μF, COUT=10μF, TA=25°C, unless otherwise noted.)

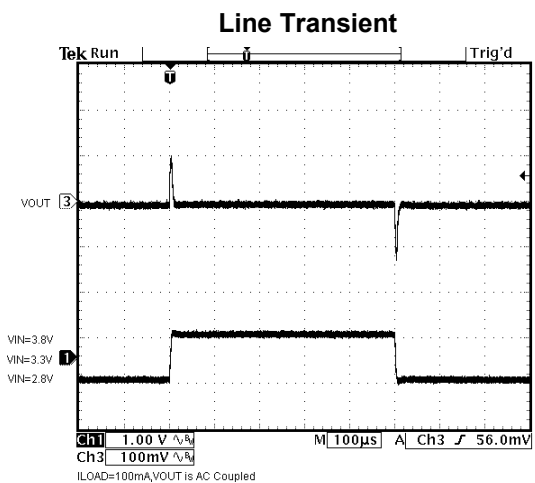
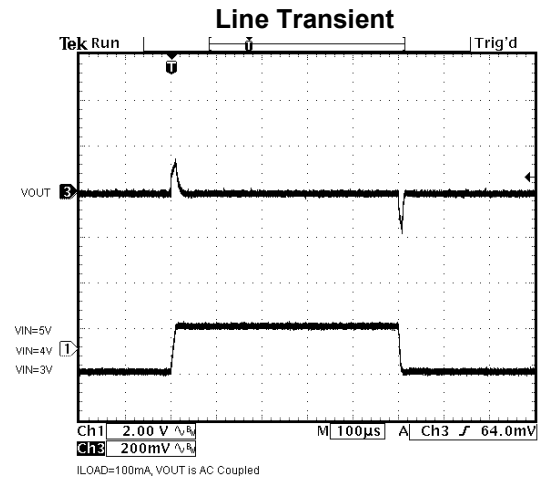
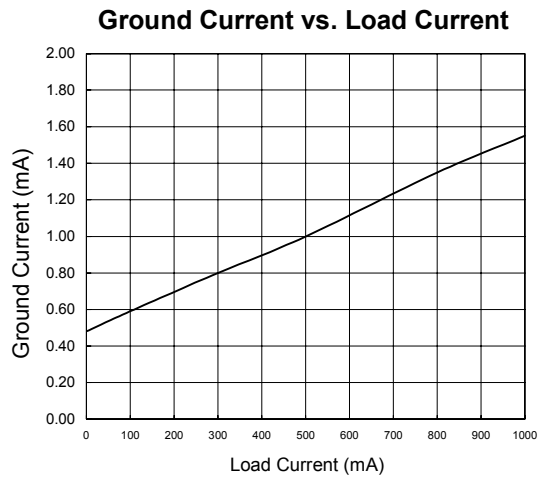
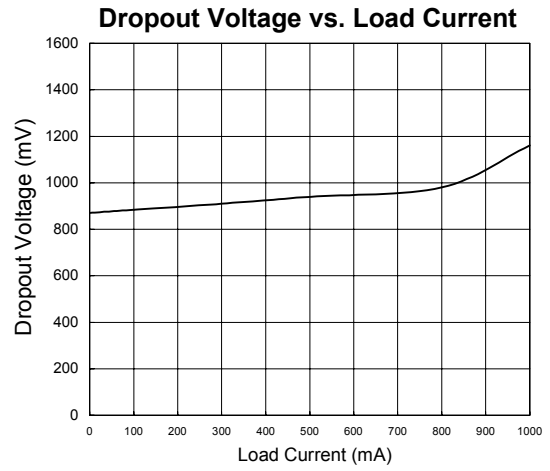
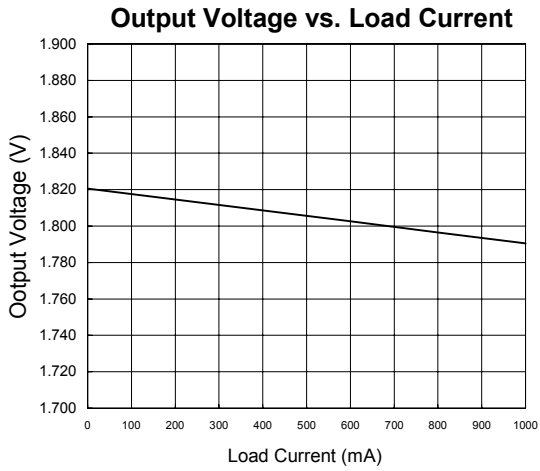



Typical Performance Characteristics (continued)

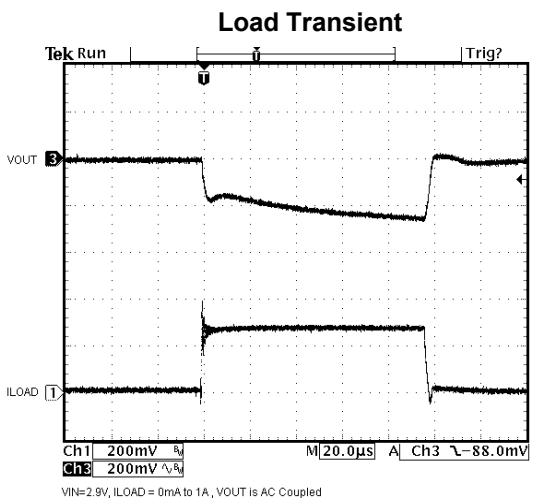
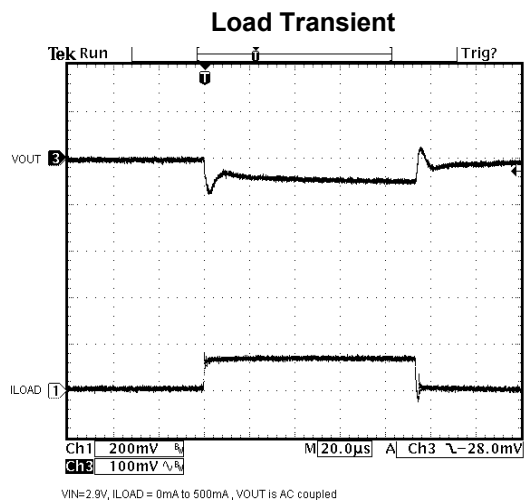
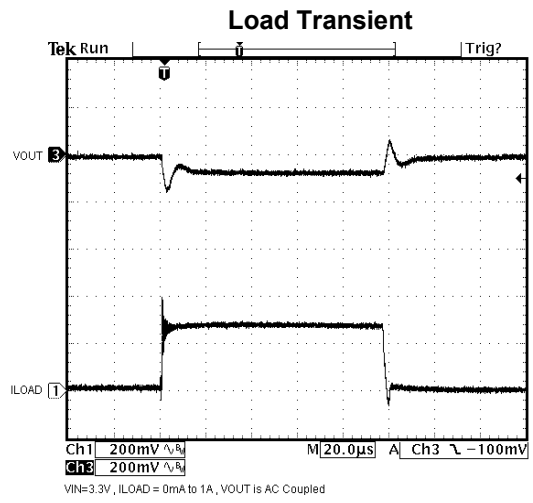
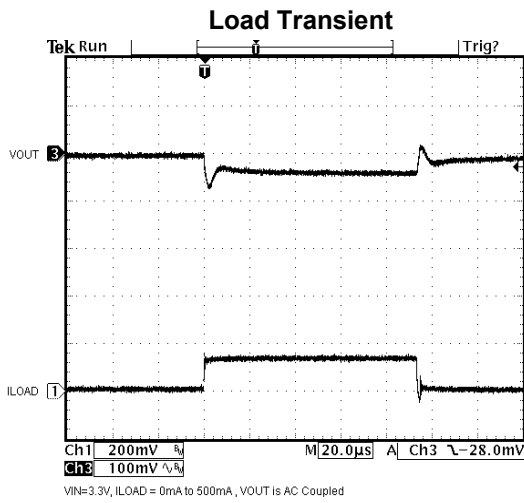

**Safe Operating Area of SOT 223**

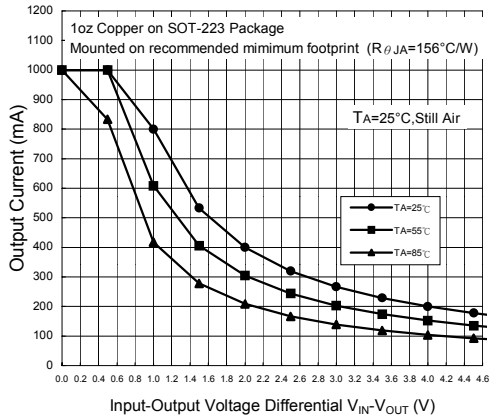

Note:  $V_{IN(max)} \leq 6.5V$

**Maximum Power Dissipation of SOT 223**

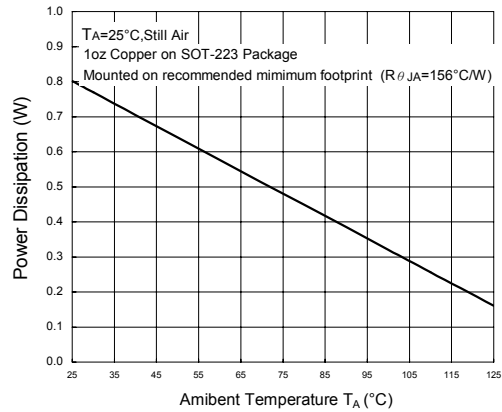

**Safe Operating Area of SOT-89 [Power Dissipation Limit]**

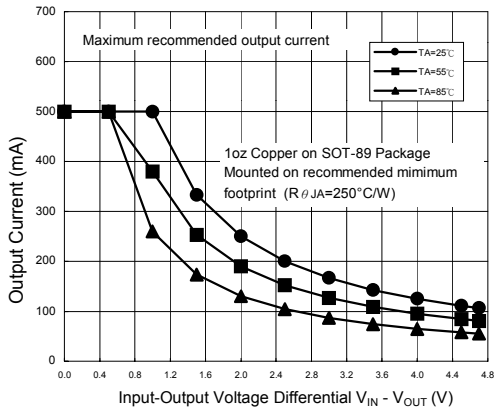

Note:  $V_{IN(max)} \leq 6.5V$

**Maximum Power Dissipation of SOT-89**

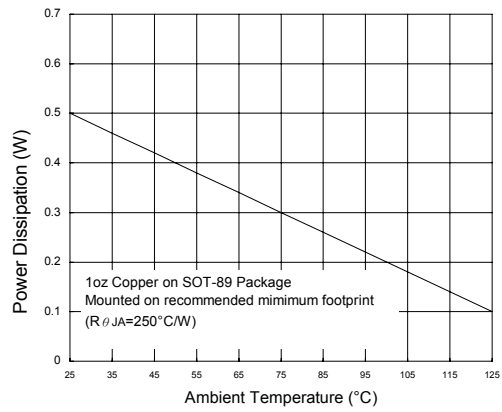

**Safe Operating Area of SOT 223**

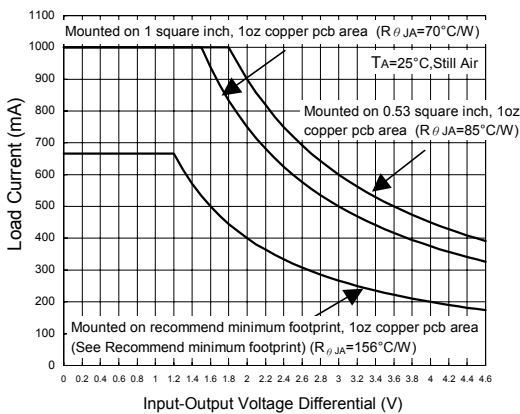

**Recommend Minimum Footprint**

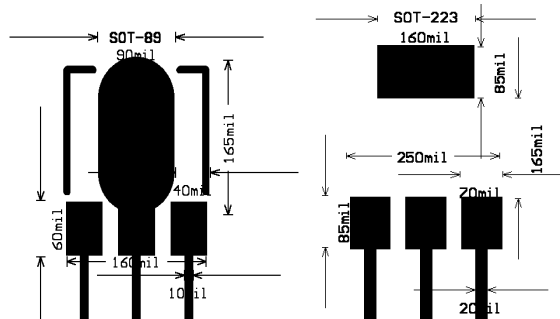

Package Information

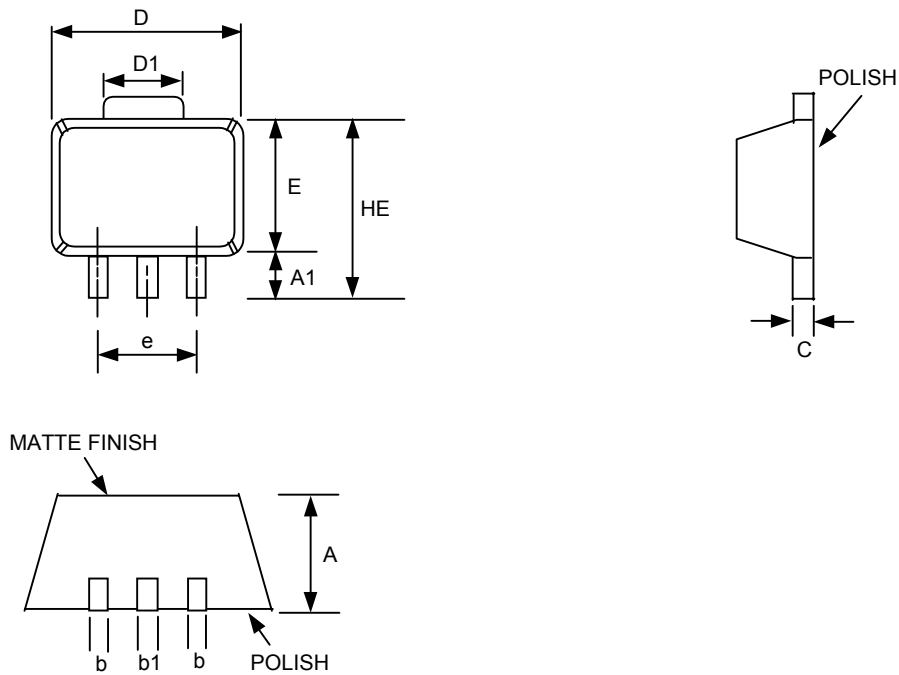

SOT-89 (T2) Package

SYMBOLS	DIMENSIONS IN MILLIMETERS			DIMENSIONS IN INCHES		
	MIN	NOM	MAX	MIN	NOM	MAX
A	1.40	1.50	1.60	0.055	0.059	0.063
A1	0.80	1.04	-----	0.031	0.041	-----
b	0.36	0.42	0.48	0.014	0.016	0.048
b1	0.41	0.47	0.53	0.016	0.018	0.020
C	0.38	0.40	0.43	0.014	0.015	0.017
D	4.40	4.50	4.60	0.173	0.177	0.181
D1	1.40	1.60	1.75	0.055	0.062	0.069
HE	-----	-----	4.25	-----	-----	0.167
E	2.40	2.50	2.60	0.094	0.098	0.102
e	2.90	3.00	3.10	0.114	0.118	0.122

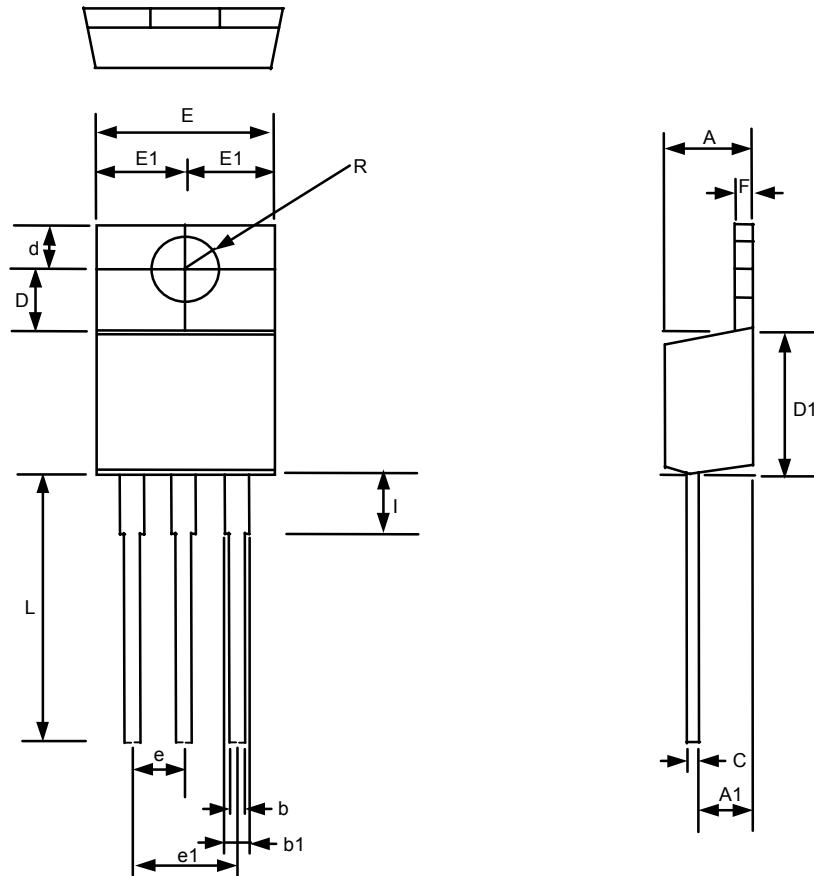

TO-220 (T3) Package

SYMBOLS	MILLIMETERS		INCHES	
	MIN	MAX	MIN	MAX
A	4.318	4.826	0.170	0.190
A1	2.46	2.72	0.097	0.107
b	0.69	0.94	0.027	0.037
b1	1.143	1.397	0.045	0.055
C	0.304	0.460	0.012	0.018
D	3.429	3.683	0.135	0.145
D1	8.53	9.04	0.336	0.356
d	2.62	2.87	0.103	0.113
E	9.906	10.40	0.390	0.410
E1	2.84	5.13	0.112	0.202
e	2.29	2.79	0.090	0.110
e1	4.83	5.33	0.190	0.210
F	1.143	1.397	0.045	0.055
I	3.454	3.962	0.136	0.156
L	13.589	14.351	0.535	0.565

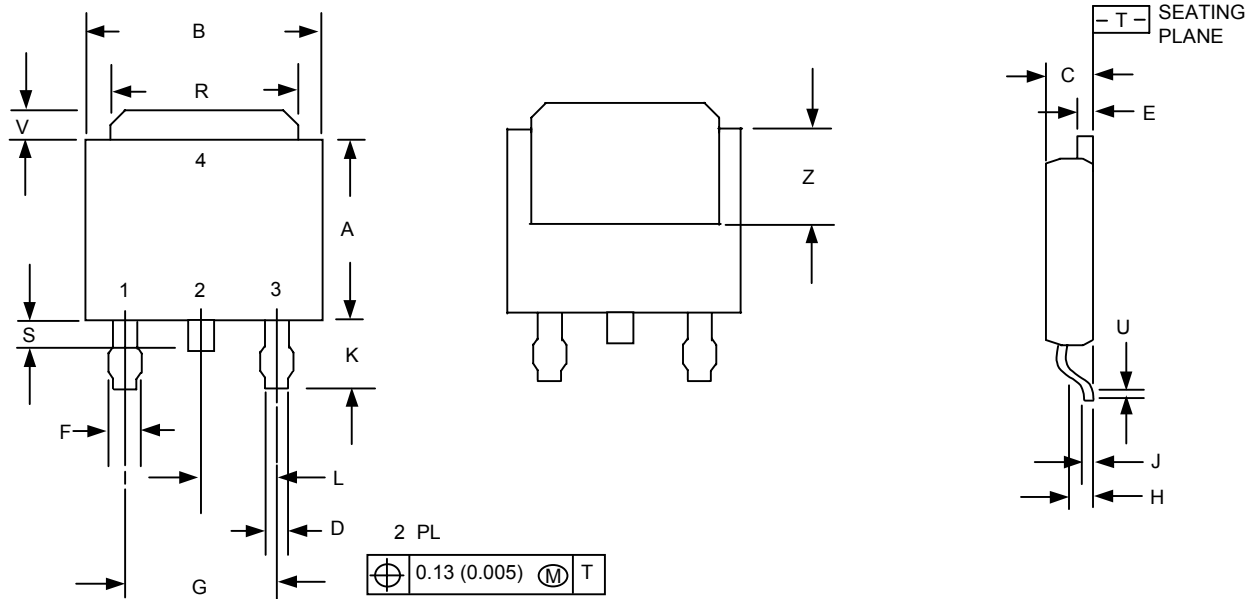

TO-252 (T4) Package

Notes:

1. Dimensioning and tolerancing per ansiy14.5m, 1982.
2. Controlling dimension: inch

DIM	INCHES		MILLIMETERS	
	MIN	MAX	MIN	MAX
A	0.235	0.250	5.97	6.35
B	0.250	0.265	6.35	6.73
C	0.086	0.094	2.19	2.38
D	0.027	0.035	0.69	0.88
E	0.033	0.040	0.84	1.01
F	0.037	0.047	0.94	1.19
G	0.180BSC		4.58BSC	
H	0.034	0.040	0.87	1.01
J	0.018	0.023	0.46	0.58
K	0.102	0.114	2.60	2.89
L	0.090BSC		2.29BSC	
R	0.175	0.215	4.45	6.46
S	0.020	0.050	0.51	1.27
U	0.020	---	0.51	---
V	0.030	0.050	0.77	1.27
Z	0.138	---	3.51	---



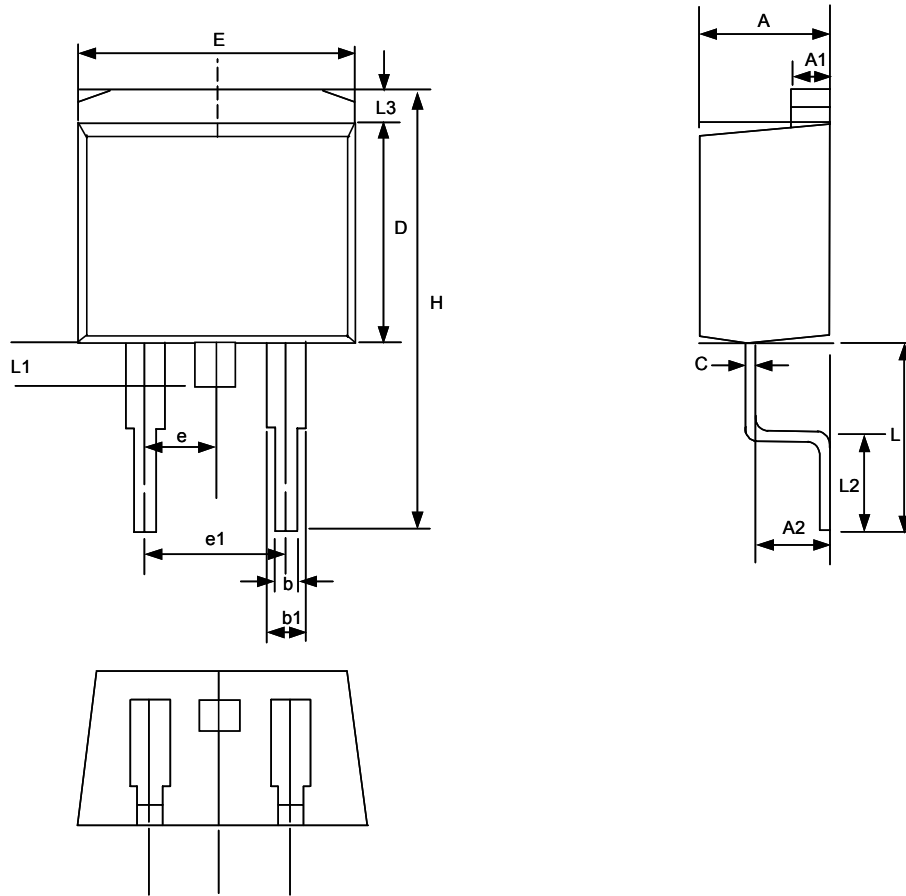

TO-263 (T5) Package

SYMBOLS	MILLIMETERS		INCHES	
	MIN	MAX	MIN	MAX
A	4.30	4.70	0.169	0.185
A1	1.22	1.32	0.048	0.055
A2	2.45	2.69	0.104	0.106
b	0.69	0.94	0.027	0.037
b1	1.22	1.40	0.048	0.055
C	0.36	0.56	0.014	0.022
D	8.64	9.652	0.340	0.380
E	9.70	10.54	0.382	0.415
e	2.29	2.79	0.090	0.110
e1	4.83	5.33	0.190	0.210
H	14.60	15.78	0.575	0.625
L	4.70	5.84	0.185	0.230
L1	1.20	1.778	0.047	0.070
L2	2.24	2.84	0.088	0.111
L3	1.40MAX		0.055MAX	

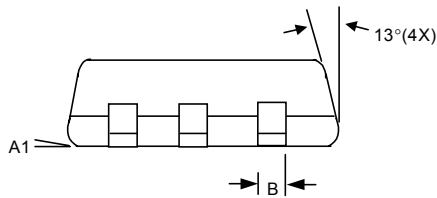
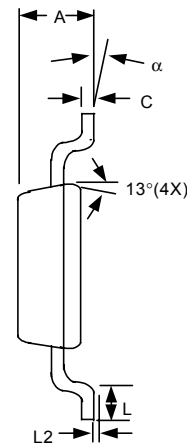
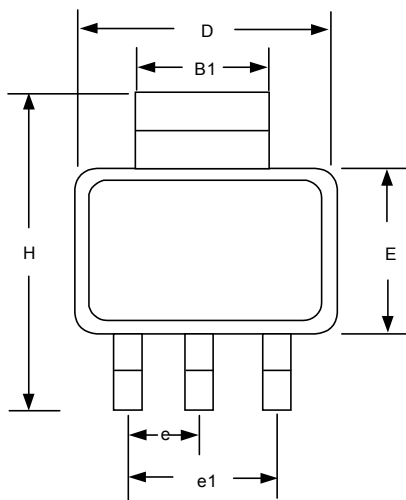

SOT-223 (T6) Package

SYMBOLS	MILLIMETERS		INCHES	
	MIN	MAX	MIN	MAX
A	1.55	1.80	0.061	0.071
A1	0.02	0.12	0.0008	0.0047
B	0.60	0.80	0.024	0.031
B1	2.90	3.10	0.114	0.122
C	0.24	0.32	0.009	0.013
D	6.30	6.70	0.248	0.264
E	3.30	3.70	0.130	0.146
e	2.30 BSC		0.090 BSC	
e1	4.60 BSC		0.181 BSC	
H	6.70	7.30	0.264	0.287
L	0.90 MIN		0.036 MIN	
L2	0.06 BSC		0.0024 BSC	
$\alpha$	0°	10°	0°	10°

Package Orientation

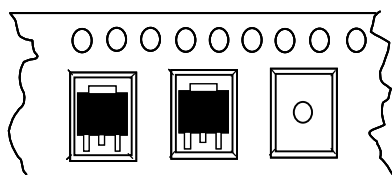

Feed Direction  
TO252 - 263 Package Orientation

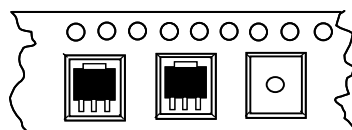

Feed Direction  
SOT 89 - 223 Package Orientation

GMT Inc. does not assume any responsibility for use of any circuitry described, no circuit patent licenses are implied and GMT Inc. reserves the right at any time without notice to change said circuitry and specifications.