



300mA Low-Dropout Linear Regulators

Features

- 90µA Quiescent Current
- Guaranteed 300mA Output Current
- Dropout Voltage is 0.4V @ I_o = 300mA
- Over-Temperature Protection and Short-Circuit Protection
- Stable With Low Cost Ceramic Capacitors
- Fixed Output Voltage :1.5V, 1.8V, 2.5V, 3.3V

Applications

- Cordless Phones
- PDAs
- Hand-Held Devices
- Bar Code Scanners
- Electronic Scales

General Description

The G9131 is a low supply current, low dropout linear regulator that comes in a space saving SOT-23 package. The supply current at no-load is 90µA. An over temperature protection circuit is built-in in the G9131 to prevent thermal overload. These power saving features make the G9131 ideal for use in the battery-powered applications such as notebook computers, cellular phones, and PDA's.

Ordering Information

ORDER NUMBER	ORDER NUMBER (Pb free)	MARKING	VOLTAGE	TEMP. RANGE	PACKAGE
G9131-15T73U	G9131-15T73Uf	35xx	1.5V	-40°C to +85°C	SOT-23
G9131-18T73U	G9131-18T73Uf	38xx	1.8V	-40°C to +85°C	SOT-23
G9131-25T73U	G9131-25T73Uf	32xx	2.5V	-40°C to +85°C	SOT-23
G9131-33T73U	G9131-33T73Uf	31xx	3.3V	-40°C to +85°C	SOT-23
G9131-33T24U	G9131-33T24Uf	31xx	3.3V	-40°C to +85°C	SOT-89

* For other package types, pin options and package, please contact us at sales@gmt.com.tw

Order Number Identification

GXXX—XX XX X X

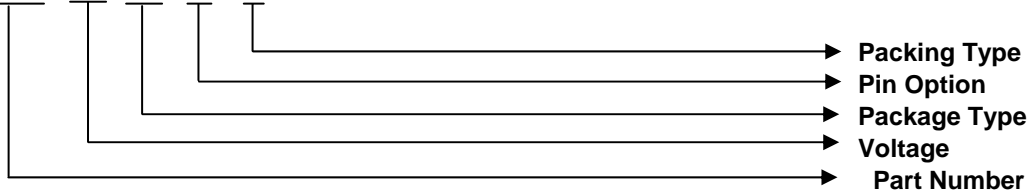

PACKAGE TYPE

T2 : SOT-89
T7 : SOT-23

PIN OPTION

	1	2	3
1 :	V _{OUT}	GND	V _{IN}
2 :	V _{OUT}	V _{IN}	GND
3 :	GND	V _{OUT}	V _{IN}
4 :	GND	V _{IN}	V _{OUT}
5 :	V _{IN}	GND	V _{OUT}
6 :	V _{IN}	V _{OUT}	GND

PACKING

U: Tape & Reel Direction

Package Type

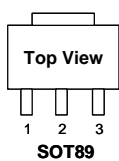

Typical Application

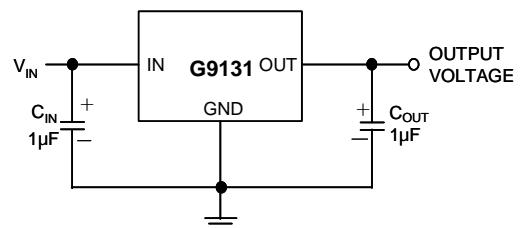



Absolute Maximum Ratings	(Note 1)
Input Voltage.....	7V
Power Dissipation Internally Limited	(Note2)
Maximum Junction Temperature.....	150°C
Storage Temperature Range.....	-65°C ≤ T _J ≤ +150°C
Reflow Temperature (soldering, 10sec)	260°C
Thermal Resistance Junction to Ambient, (θ _{JA})	
SOT-23 ⁽¹⁾	276°C/W
SOT-89 ⁽¹⁾	173°C/W
Thermal Resistance Junction to Case, (θ _{JC})	
SOT-89.....	24°C/W

Operating Conditions	(Note 1)
Input Voltage.....	3V ~ 6V
Temperature Range.....	-40°C ≤ T _A ≤ 85°C

Note ⁽¹⁾: See Recommended Minimum Footprint.

Electrical Characteristics

V_{IN} = 5V, I_O = 300mA, C_{IN} = 1μF, C_{OUT} = 1μF. All specifications apply for T_A = T_J = 25°C. [Note 3]

PARAMETER	CONDITION	MIN	TYP	MAX	UNIT	
Output Voltage	5mA ≤ I _O ≤ 300mA	V _O = 3.3V	3.234	3.3	3.366	V
		V _O = 2.5V	2.45	2.5	2.55	
		V _O = 1.8V	1.764	1.8	1.845	
		V _O = 1.5V	1.455	1.5	1.545	
Line Regulation	4V ≤ V _{IN} ≤ 6V, I _O = 10mA	---	15	---	mV	
Load Regulation	10mA ≤ I _O ≤ 300mA	---	10	---	mV	
Quiescent Current	V _{IN} = 5V	---	90	150	μA	
Ripple Rejection	f _i = 120 Hz, 1V _{P-P} , I _O = 100mA	---	45	---	dB	
Dropout Voltage	I _O = 300mA	V _O = 3.3V	---	0.4	---	V
		V _O = 2.5V	---	0.5	---	
		V _O = 1.8V	---	0.8	---	
		V _O = 1.5V	---	0.9	---	
Short Circuit Current		---	0.65	---	A	
Current Limit		---	0.8	---	A	
Over Temperature		---	145	---	°C	
Over Temperature Hysteresis		---	25	---	°C	

Note 1: Absolute Maximum Ratings are limits beyond which damage to the device may occur. Operating Conditions are conditions under which the device functions but the specifications might not be guaranteed. For guaranteed specifications and test conditions see the Electrical Characteristics.

Note2: The maximum power dissipation is a function of the maximum junction temperature, T_{Jmax}; total thermal resistance, θ_{JA}, and ambient temperature T_A. The maximum allowable power dissipation at any ambient temperature is T_{Jmax} - T_A / θ_{JA}. If this dissipation is exceeded, the die temperature will rise above 150°C and IC will go into thermal shutdown. For the G9131 in SOT-23 package, θ_{JA} is 276°C/W and in the SOT-89 package is 173°C/W (See Recommended Minimum Footprint). The safe operation in SOT-89 & SOT-23 package, it can see "Typical Performance Characteristics" (Safe Operating Area).

Note3: Low duty pulse techniques are used during test to maintain junction temperature as close to ambient as possible.

Note4: The type of output capacitor should be tantalum, aluminum or ceramic.



Definitions

Dropout Voltage

The input/output Voltage differential at which the regulator output no longer maintains regulation against further reductions in input voltage. Measured when the output drops 100mV below its nominal value, dropout voltage is affected by junction temperature, load current and minimum input supply requirements.

Line Regulation

The change in output voltage for a change in input voltage. The measurement is made under conditions of low dissipation or by using pulse techniques such that average chip temperature is not significantly affected.

Load Regulation

The change in output voltage for a change in load current at constant chip temperature. The measurement is made under conditions of low dissipation or by using pulse techniques such that average chip temperature is not significantly affected.

Maximum Power Dissipation

The maximum total device dissipation for which the regulator will operate within specifications.

Quiescent Bias Current

Current which is used to operate the regulator chip and is not delivered to the load.

Typical Performance Characteristics

($V_{IN} = V_O + 1V$, $C_{IN} = 1\mu F$, $C_{OUT} = 1\mu F$, $T_A = 25^\circ C$, unless otherwise noted.)

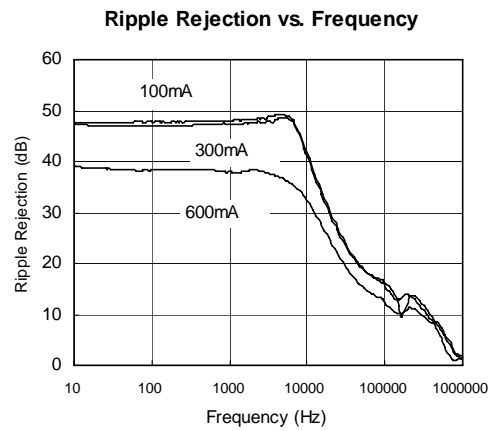
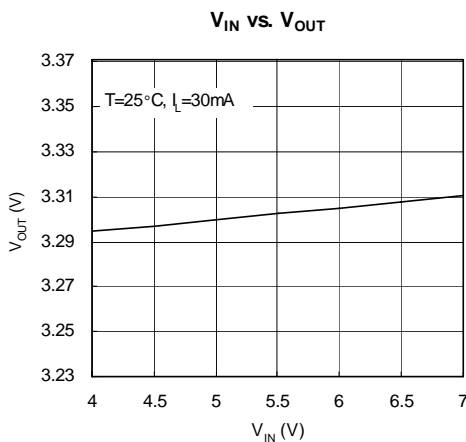
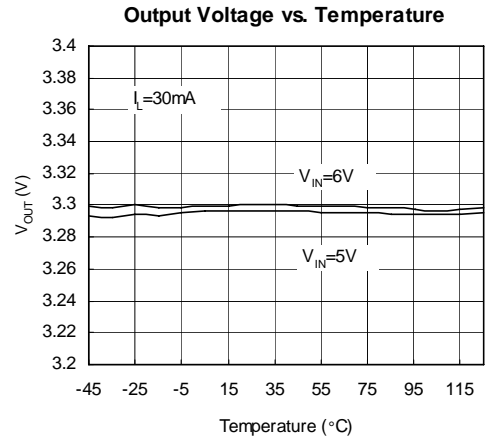
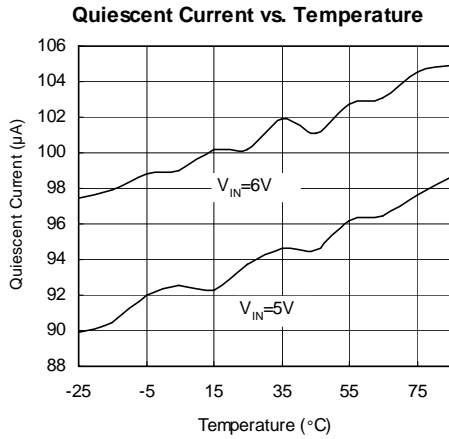
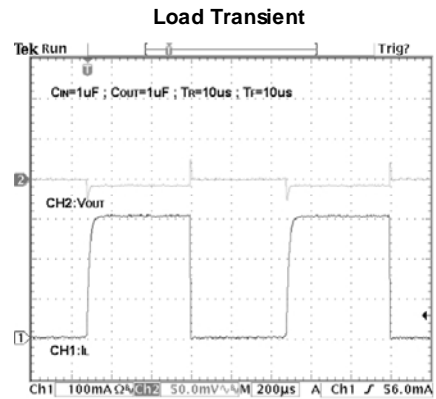
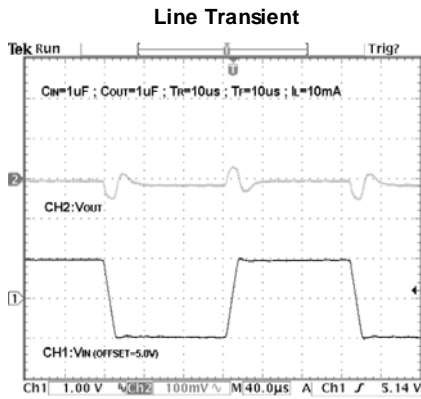

Typical Performance Characteristics (continue)

Output Noise

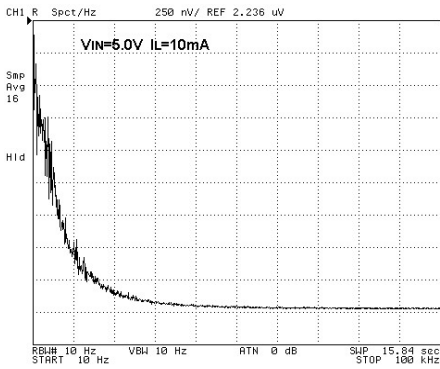

Start-Up

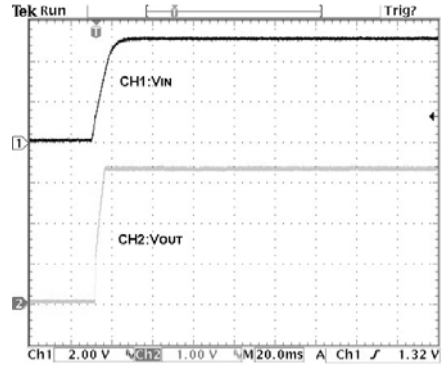

Dropout Voltage vs. Temperature

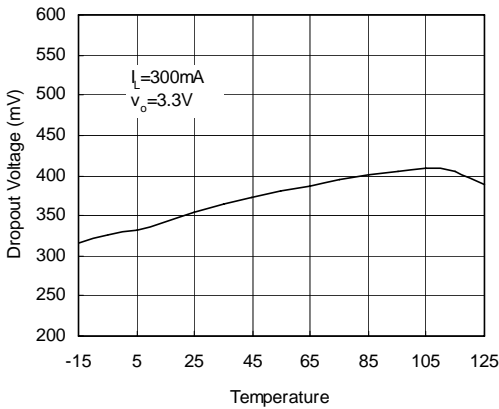

Output Current vs. Output Voltage

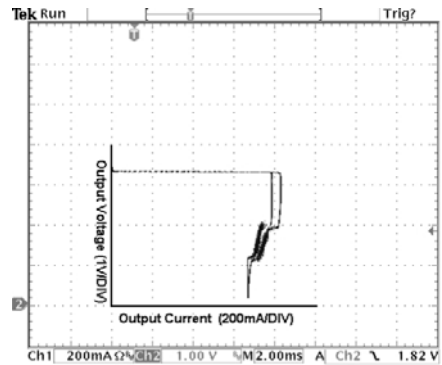

SOT-89 Max. Power Dissipation vs. PCB Top Copper Area
 $T_{AMB} = 25^\circ C$; Still Air

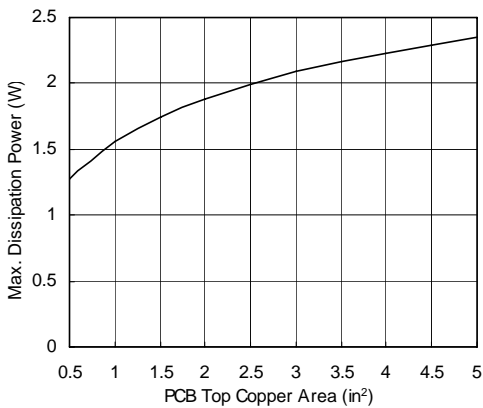

SOT-89 Max. Power Dissipation vs. T_{AMB} (still air)
(Different PCB Top Copper Area)

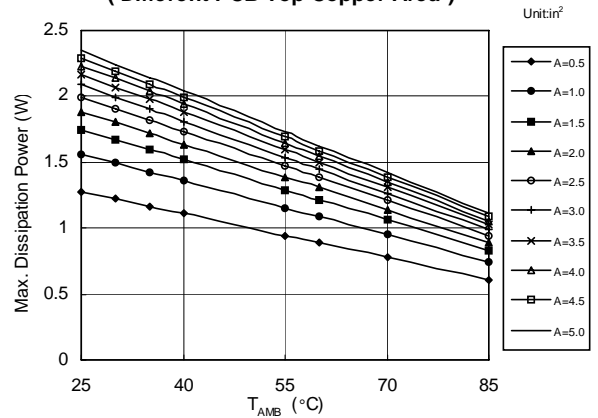

Recommended Minimum Footprint

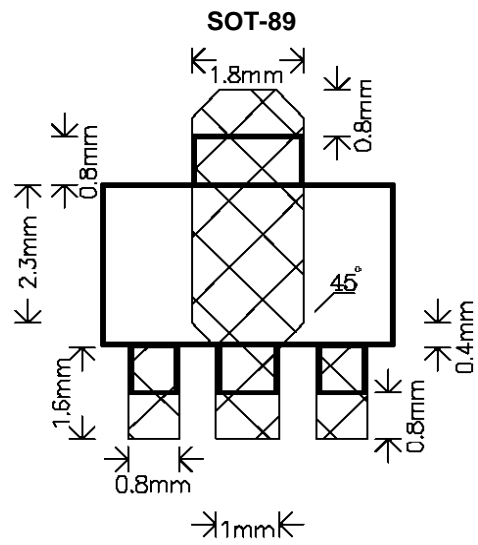
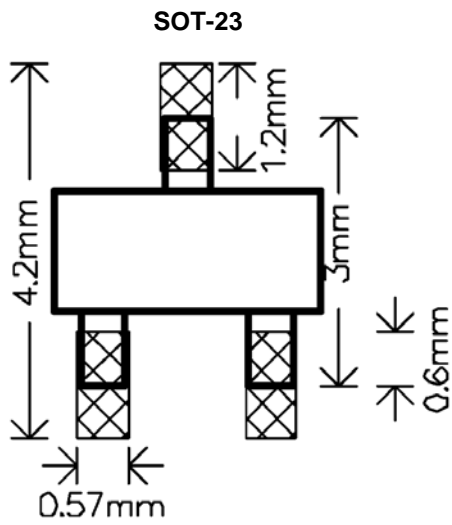

**Pin Description**

NAME	FUNCTION
IN	Regulator Input. Supply voltage can range from $V_{IN(min)}$ to +5.5V. Bypass with 1 μ F to GND.
GND	This is ground pin.
OUT	Regulator Output. Sources up to 300mA. Bypass with a 1 μ F, <0.2 Ω typical ESR capacitor to GND.

Detailed Description

The block diagram of the G9131 is shown in Figure 1. It consists of an error amplifier, 1.25V bandgap reference, PMOS output transistor, internal feedback voltage divider, over current protection circuit, and over temperature protection circuit.

Over Current Protection

The G9131 use a current sense-resistor to monitor the output current. A portion of the PMOS output transistor's current is mirrored to a resistor such that the voltage across this resistor is proportional to the output current. Once the output current exceeds limit threshold, G9131 would be protected with a limited output current. Further more, when the output is short to ground, the output current would be folded-back to a less limit.

Over Temperature Protection

To prevent abnormal temperature from occurring, the G9131 has a built-in temperature monitoring circuit.

When it detects the temperature is above 150°C, the output transistor is turned off. When the IC is cooled down to below 135°C, the output is turned on again. In this way, the G9131 will be protected against abnormal junction temperature during operation.

Operating Region and Power Dissipation

Since the G9131 is a linear regulator, its power dissipation is always given by $P = I_{OUT} (V_{IN} - V_{OUT})$. The maximum power dissipation is given by: $P_{D(MAX)} = (T_J - T_A) / \theta_{JA}$, Where $(T_J - T_A)$ is the temperature difference the G9131 die and the ambient air. For surface mount device, heat sinking is accomplished by using the heat spreading capabilities of the PC board and its copper traces. θ_{JA} is the thermal resistance of the chosen package to the ambient air. In the case of a SOT-23 package, the thermal resistance is typically 275.5°C/W. In SOT 89 $R_{\theta JA}$ is 172.5°C/W.

Applications Information

Capacitor Selection and Regulator Stability

Normally, use a 1 μ F capacitor on the input and a 1 μ F capacitor on the output of the G9131. Larger input capacitor values and lower ESR provide better supply-noise rejection and transient response. For stable operation over the full temperature range, with load currents up to 120mA, a minimum of 1 μ F is recommended.

Power-Supply Rejection and Operation from Sources Other than Batteries

The G9131 is designed to deliver low dropout voltages and low quiescent currents in battery powered systems. Power-supply rejection is 47dB at low frequencies the output capacitor is the major contributor to the rejection of power-supply noise.

When operating from sources other than batteries, improve supply-noise rejection and transient response by increasing the values of the input and output capacitors, and using passive filtering techniques.

Load Transient Considerations

The G9131 load-transient response graphs show two components of the output response: a DC shift of the output voltage due to the different load currents, and the transient response. Typical overshoot for step changes in the load current from 0mA to 300mA is 10mV. Increasing the output capacitor's value and decreasing its ESR attenuates transient spikes.

Input-Output (Dropout) Voltage

A regulator's minimum input-output voltage differential (or dropout voltage) determines the lowest usable supply voltage. In battery-powered systems, this will determine the useful end-of-life battery voltage. Because the G9131 use a P-channel MOSFET pass transistor, their dropout voltage is a function of $R_{DS(ON)}$ multiplied by the load current.

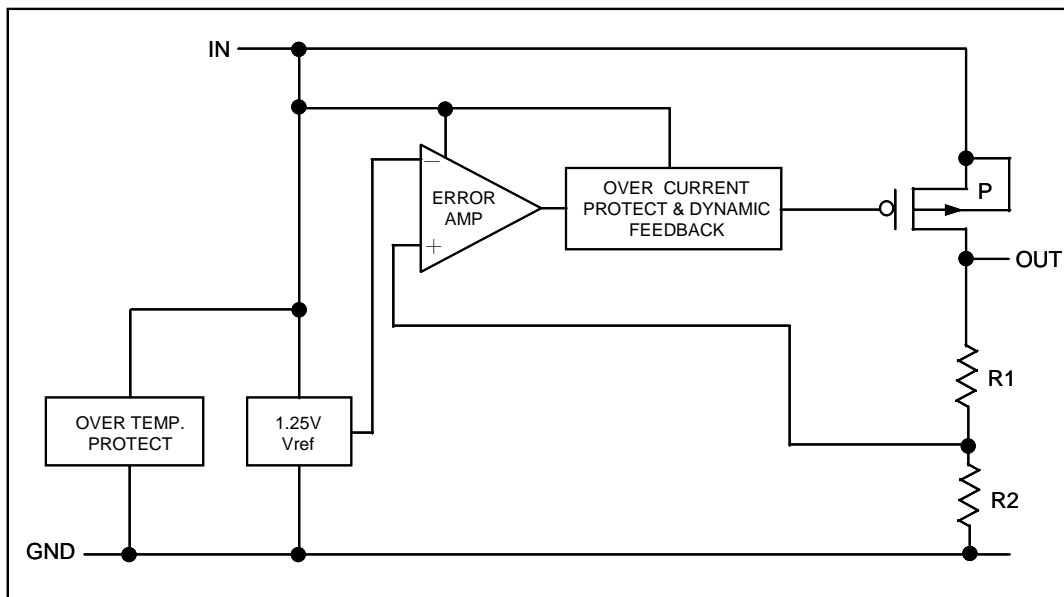
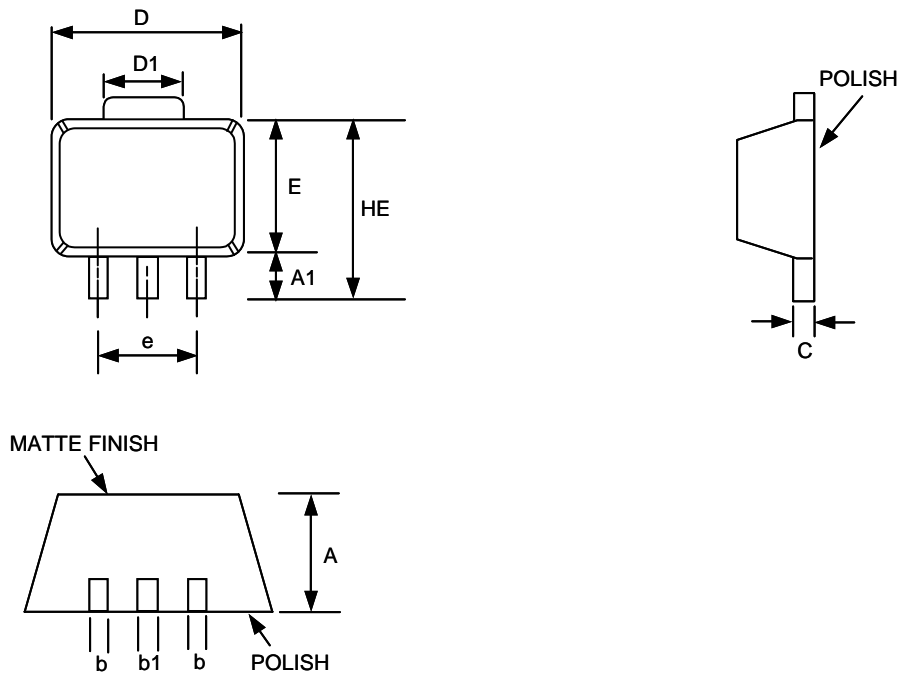

Figure 1. Functional Diagram

Package Information



SOT-89 (T2) Package

SYMBOL	DIMENSION IN MILLIMETER			DIMENSION IN INCH		
	MIN	NOM	MAX	MIN	NOM	MAX
A	1.40	1.50	1.60	0.055	0.059	0.063
A1	0.80	1.04	-----	0.031	0.041	-----
b	0.36	0.42	0.48	0.014	0.016	0.018
b1	0.41	0.47	0.53	0.016	0.018	0.020
C	0.38	0.40	0.43	0.014	0.015	0.017
D	4.40	4.50	4.60	0.173	0.177	0.181
D1	1.40	1.60	1.75	0.055	0.062	0.069
HE	-----	-----	4.25	-----	-----	0.167
E	2.40	2.50	2.60	0.094	0.098	0.102
e	2.90	3.00	3.10	0.114	0.118	0.122

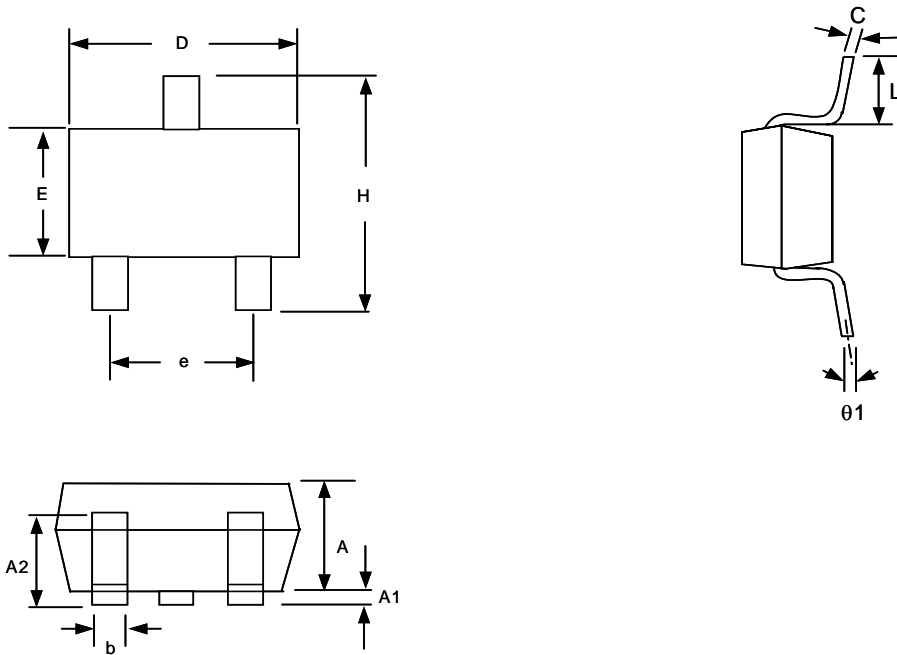

SOT-23 (T7) Package

Note:

- 1.Package body sizes exclude mold flash protrusions or gate burrs
- 2.Tolerance ± 0.1000 mm (4mil) unless otherwise specified
- 3.Coplanarity: 0.1000mm
- 4.Dimension L is measured in gage plane

SYMBOL	DIMENSION IN MILLIMETER		
	MIN	NOM	MAX
A	1.00	1.10	1.30
A1	0.00	-----	0.10
A2	0.70	0.80	0.90
b	0.35	0.40	0.50
C	0.10	0.15	0.25
D	2.70	2.90	3.10
E	1.40	1.60	1.80
e	-----	1.90(TYP)	-----
H	2.60	2.80	3.00
L	0.37	-----	-----
$\theta 1$	1°	5°	9°

Taping Specification

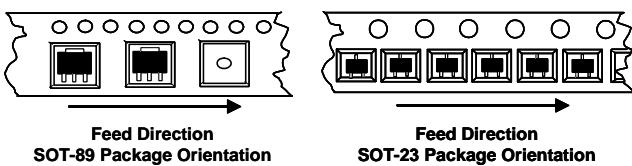

PACKAGE	Q'TY/BY REEL
SOT-23	3,000 ea
SOT-89	1,000 ea

GMT Inc. does not assume any responsibility for use of any circuitry described, no circuit patent licenses are implied and GMT Inc. reserves the right at any time without notice to change said circuitry and specifications.