

# InGaAs PIN photodiode G8421/G8371/G5851 series

## Long wavelength type

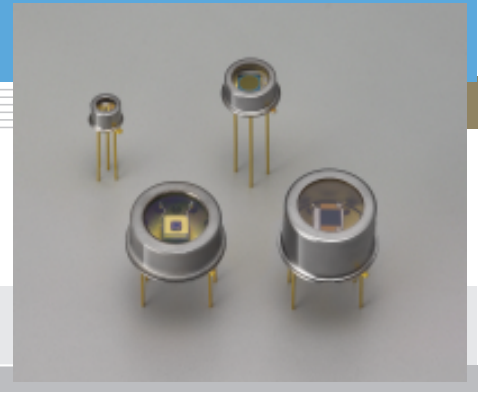

### Features

- Long cut-off wavelength: 1.9  $\mu\text{m}$
- 3-pin TO-18 package: low price
- Thermoelectrically cooled TO-18 package: low dark current
- Active area:  $\phi 0.3$  to  $\phi 3$  mm

### Applications

- Optical power meter
- Gas analyzer
- NIR (near infrared) photometry

### Accessories (Optional)

- Heatsink for one-stage TE-cooled type A3179
- Heatsink for two-stage TE-cooled type A3179-01
- Temperature controller for TE-cooled type C1103-04

### Specifications / Absolute maximum ratings

Type No.	Dimensional outline/ Window material	Package	Cooling	Active area (mm)	Absolute maximum ratings				
					Thermistor power dissipation (mW)	TE-cooler allowable current (A)	Reverse voltage $V_R$ (V)	Operating temperature $T_{opr}$ ( $^{\circ}\text{C}$ )	Storage temperature $T_{stg}$ ( $^{\circ}\text{C}$ )
G8421-03	①	TO-18	Non-cooled	$\phi 0.3$	-	-	2	-40 to +85	-55 to +125
G8421-05				$\phi 0.5$					
G8371-01				$\phi 1$					
G8371-03				$\phi 3$					
G5851-103	③	TO-8	One-stage TE-cooled	$\phi 0.3$	0.2	1.5	2	-40 to +70	-55 to +85
G5851-11				$\phi 1$					
G5851-13				$\phi 3$					
G5851-203	④	TO-8	Two-stage TE-cooled	$\phi 0.3$	0.2	1.0	2	-40 to +70	-55 to +85
G5851-21				$\phi 1$					
G5851-23				$\phi 3$					

### Electrical and optical characteristics (Typ. unless otherwise noted)

Type No.	Measurement Condition	Spectral response range $\lambda$ ( $\mu\text{m}$ )	Peak sensitivity wavelength $\lambda_p$ ( $\mu\text{m}$ )	Photo sensitivity $S$ $\lambda = \lambda_p$		Dark current $I_D$ $V_R = 1 \text{ V}$		Cut-off frequency $f_c$ $V_R = 1 \text{ V}$ $R_L = 50 \Omega$ -3 dB (MHz)	Terminal capacitance $C_t$ $V_R = 1 \text{ V}$ $f = 1 \text{ MHz}$ (pF)	Shunt resistance $R_{sh}$ $V_R = 10 \text{ mV}$ (M $\Omega$ )	$D^*$ $\lambda = \lambda_p$ ( $\text{cm} \cdot \text{Hz}^{1/2}/\text{W}$ )	NEP $\lambda = \lambda_p$ ( $\text{W}/\text{Hz}^{1/2}$ )
	Element temperature			Min. (A/W)	Typ. (A/W)	Typ. (nA)	Max. (nA)					
	( $^{\circ}\text{C}$ )											
G8421-03	25	0.9 to 1.9	1.75	0.9	1.1	30	300	100	8	1.5	$5 \times 10^{11}$	$9 \times 10^{-14}$
G8421-05						50	500	80	20	1		$1.5 \times 10^{-13}$
G8371-01						100	1000	40	80	0.5		$2 \times 10^{-13}$
G8371-03						2000	20000	3	800	0.05		$8 \times 10^{-13}$
G5851-103	-10	0.9 to 1.87	1.75	0.9	1.1	3	30	100	8	15	$1.5 \times 10^{12}$	$3 \times 10^{-14}$
G5851-11						10	100	40	80	5		$6 \times 10^{-14}$
G5851-13						200	2000	3	800	0.5		$2 \times 10^{-13}$
G5851-203	-20	0.9 to 1.85	1.75	0.9	1.1	1.5	15	100	8	35	$2.5 \times 10^{12}$	$2 \times 10^{-14}$
G5851-21						5	50	40	80	10		$4 \times 10^{-14}$
G5851-23						100	1000	3	800	1		$1.5 \times 10^{-13}$

G8421/G8371/G5851 series may be damaged by Electro Static Discharge, etc. Be carefull when using G8421/G8371/G5851 series.

**SOLID STATE DIVISION**

■ Spectral response

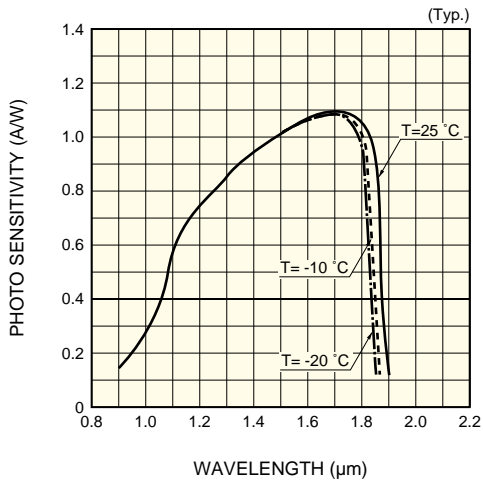

KIRDB0221EA

■ Photo sensitivity temperature characteristic

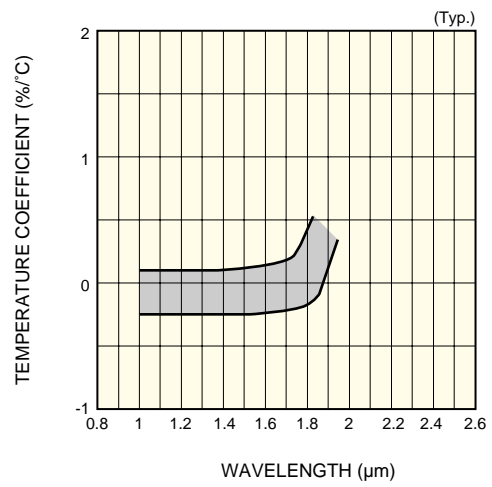

KIRDB0208EA

■ Dark current vs. reverse voltage

Non-cooled type

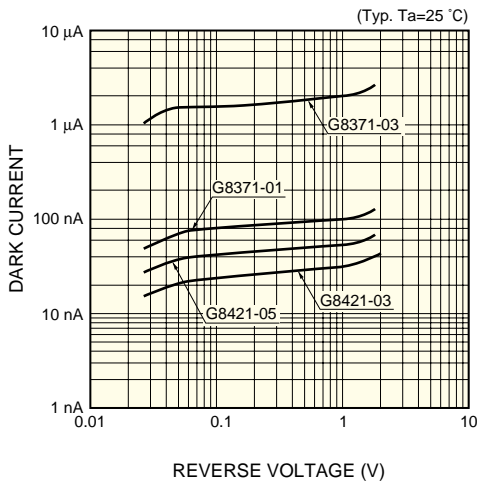

KIRDB0232EA

TE-cooled type

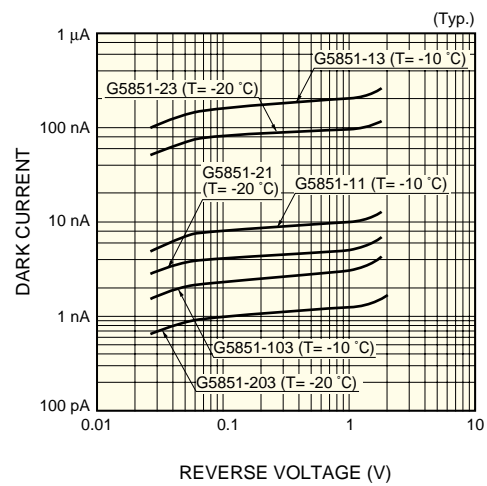

KIRDB0233EA

■ Terminal capacitance vs. reverse voltage

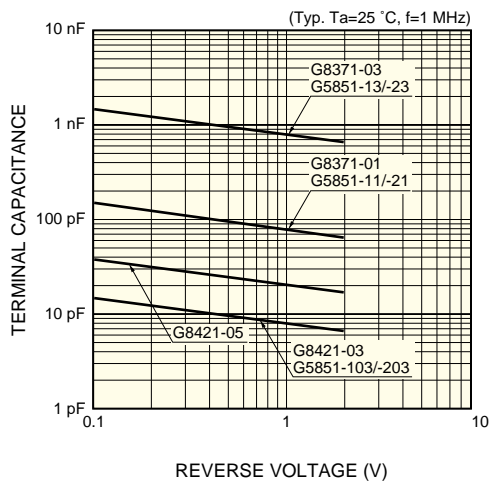

KIRDB0233EA

■ Shunt resistance vs. element temperature

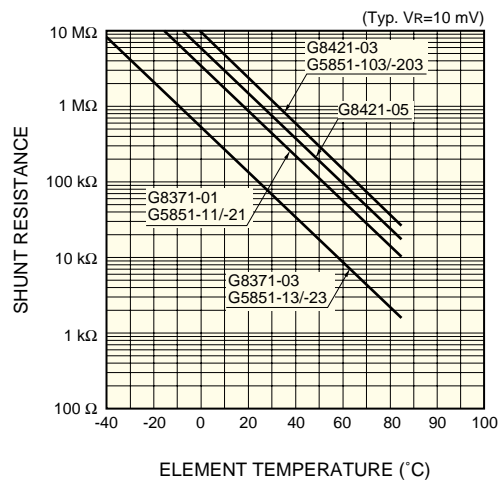

KIRDB0234EA

■ Thermistor temperature characteristic

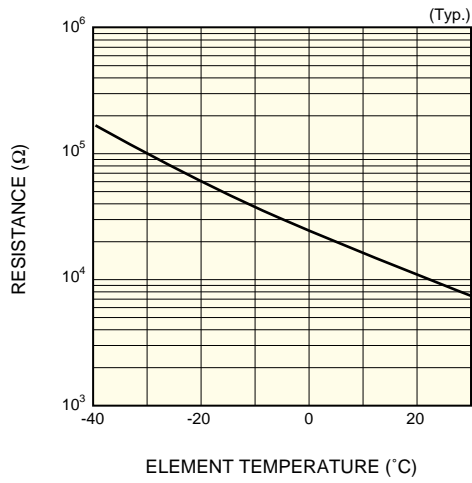

KIRDB0116EA

■ Cooling characteristics of TE-cooler

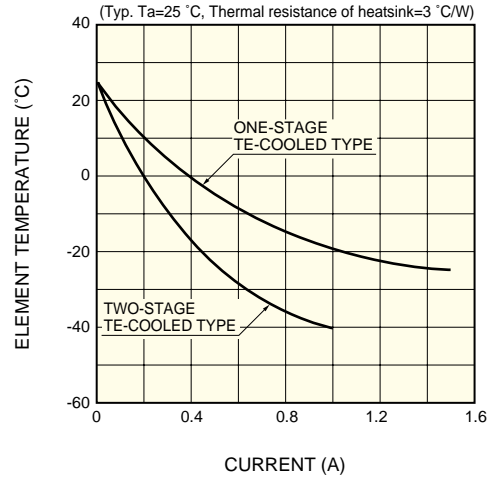

KIRDB0231EA

■ Current vs. voltage characteristics of TE-cooler

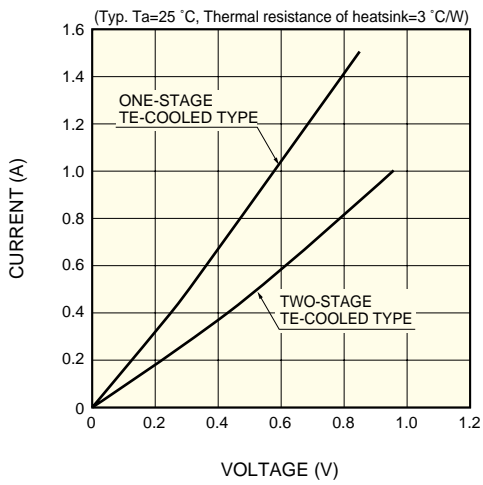

KIRDB0115EB

## Dimensional outlines (unit: mm)

① G8421-03/-05, G8371-01

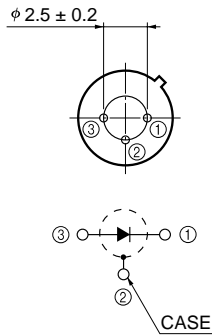
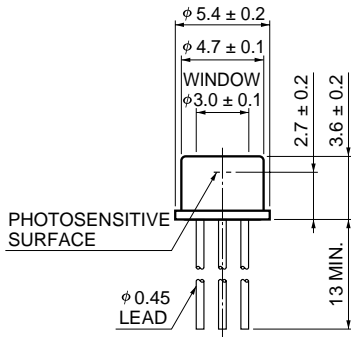

KIRDA0150EA

② G8371-03

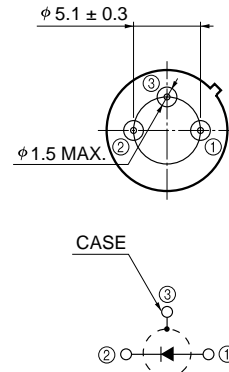
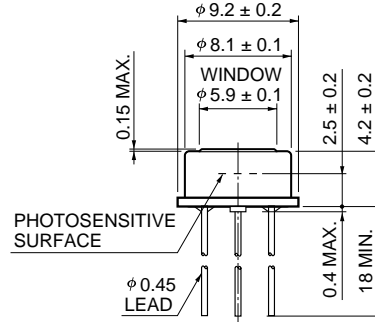

KIRDA0151EA

③ G5851-103/-11/-13

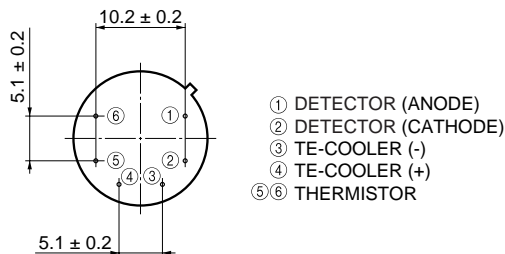
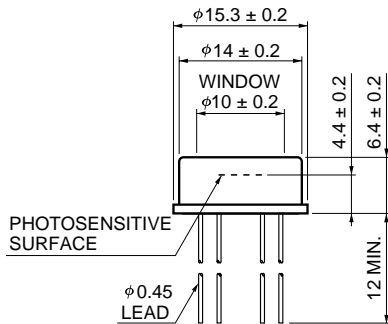

KIRDA0029EB

④ G5851-203/-21/-23

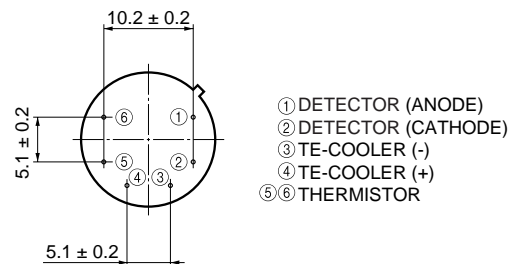
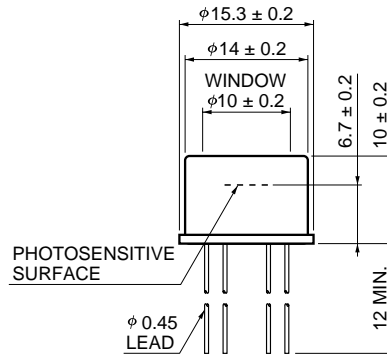

KIRDA0031EB

# HAMAMATSU

Information furnished by HAMAMATSU is believed to be reliable. However, no responsibility is assumed for possible inaccuracies or omissions. Specifications are subject to change without notice. No patent rights are granted to any of the circuits described herein. ©2006 Hamamatsu Photonics K.K.

HAMAMATSU PHOTONICS K.K., Solid State Division

1126-1 Ichino-cho, Higashi-ku, Hamamatsu City, 435-8558 Japan, Telephone: (81) 53-434-3311, Fax: (81) 53-434-5184, www.hamamatsu.com

U.S.A.: Hamamatsu Corporation: 360 Foothill Road, P.O.Box 6910, Bridgewater, N.J. 08807-0910, U.S.A., Telephone: (1) 908-231-0960, Fax: (1) 908-231-1218

Germany: Hamamatsu Photonics Deutschland GmbH: Arzbergerstr. 10, D-82211 Herrsching am Ammersee, Germany, Telephone: (49) 08152-3750, Fax: (49) 08152-2658

France: Hamamatsu Photonics France S.A.R.L.: 19, Rue du Saule Traçu, Parc du Moulin de Massy, 91882 Massy Cedex, France, Telephone: 33-(1) 69 53 71 00, Fax: 33-(1) 69 53 71 10

United Kingdom: Hamamatsu Photonics UK Limited: 2 Howard Court, 10 Tewin Road, Welwyn Garden City, Hertfordshire AL7 1BW, United Kingdom, Telephone: (44) 1707-294888, Fax: (44) 1707-325777

North Europe: Hamamatsu Photonics Norden AB: Smidesvägen 12, SE-171 41 Solna, Sweden, Telephone: (46) 8-509-031-00, Fax: (46) 8-509-031-01

Italy: Hamamatsu Photonics Italia S.R.L.: Strada della Moia, 1/E, 20020 Arese, (Milano), Italy, Telephone: (39) 02-935-81-733, Fax: (39) 02-935-81-741