



FX501

PNP Epitaxial Planar Silicon Transistor

High-Current Switching Applications

Features

- Composite type with 2 PNP transistors contained in one package, facilitating high-density mounting.
- The FX501 houses two chips, each being equivalent to the 2SB1205, in one package.
- Matched pair characteristics.

Package Dimensions

unit:mm
2118

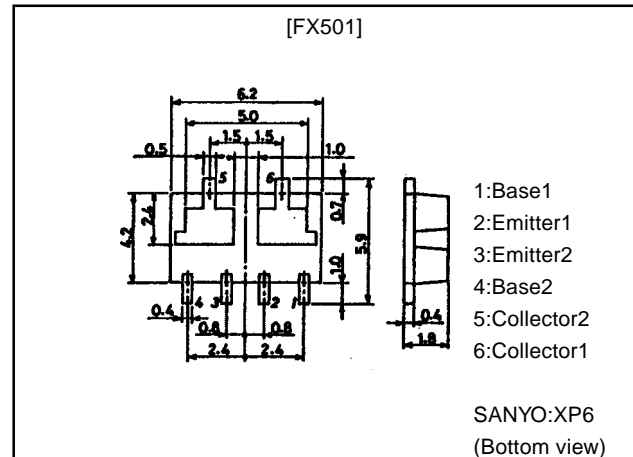

Switching Time Test Circuit

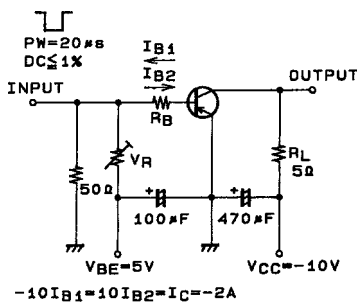

Electrical Connection

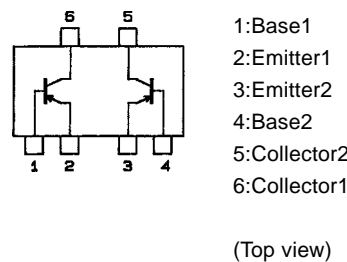

Specifications

Absolute Maximum Ratings at Ta = 25°C

Parameter	Symbol	Conditions	Ratings	Unit
Collector-to-Base Voltage	V_{CBO}		-25	V
Collector-to-Emitter Voltage	V_{CEO}		-20	V
Emitter-to-Base Voltage	V_{EBO}		-5	V
Collector Current	I_C		-5	A
Collector Current (Pulse)	I_{CP}		-8	A
Base Current	I_B		-1	A
Collector Dissipation	P_C	Mounted on ceramic board (750mm ² ×0.8mm) 1 unit	1.5	W
Total Dissipation	P_T	Mounted on ceramic board (750mm ² ×0.8mm)	2	W
Junction Temperature	T_j		150	°C
Storage Temperature	T_{stg}		-50 to +150	°C

· Marking:501

Continued on next page.

FX501

Continued from preceding page.

Electrical Characteristics at $T_a = 25^\circ\text{C}$

Parameter	Symbol	Conditions	Ratings			Unit
			min	typ	max	
Collector Cutoff Current	I_{CBO}	$V_{CB}=-20\text{V}, I_E=0$			-500	nA
Emitter Cutoff Current	I_{EBO}	$V_{EB}=-4\text{V}, I_C=0$			-500	nA
DC Current Gain	h_{FE1}	$V_{CE}=-2\text{V}, I_C=-500\text{mA}$	140		400	
	h_{FE2}	$V_{CE}=-2\text{V}, I_C=-4\text{A}$	60			
DC Current Gain Ratio	$h_{FE}(\text{small/large})$	$V_{CE}=-2\text{V}, I_C=-500\text{mA}$	0.8			
Gain-Bandwidth Product	f_T	$V_{CE}=-5\text{V}, I_C=-500\text{mA}$		350		MHz
Output Capacitance	C_{ob}	$V_{CB}=-10\text{V}, f=1\text{MHz}$		60		pF
C-E Saturation Voltage	$V_{CE}(\text{sat})$	$I_C=-3\text{A}, I_B=-60\text{mA}$		-250	-500	mV
B-E Saturation Voltage	$V_{BE}(\text{sat})$	$I_C=-3\text{A}, I_B=-60\text{mA}$		-1.0	-1.3	V
C-B Breakdown Voltage	$V_{(BR)CBO}$	$I_C=-10\mu\text{A}, I_E=0$	-25			V
C-E Breakdown Voltage	$V_{(BR)CEO}$	$I_C=-1\text{mA}, R_{BE}=\infty$	-20			V
E-B Breakdown Voltage	$V_{(BR)EBO}$	$I_E=-10\mu\text{A}, I_C=0$	-5			V
Turn-ON Time	t_{on}	See specified Test Circuit		40		ns
Storage Time	t_{stg}	See specified Test Circuit		200		ns
Fall Time	t_f	See specified Test Circuit		10		ns

FX501

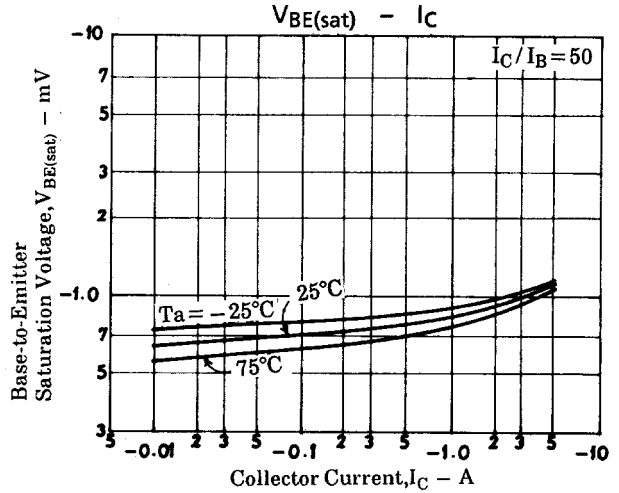
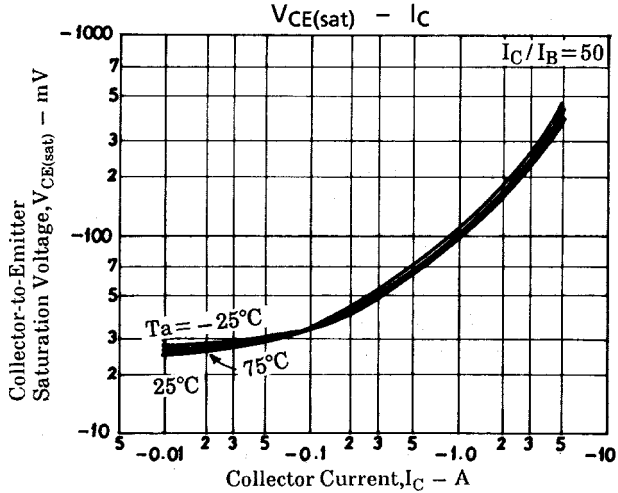
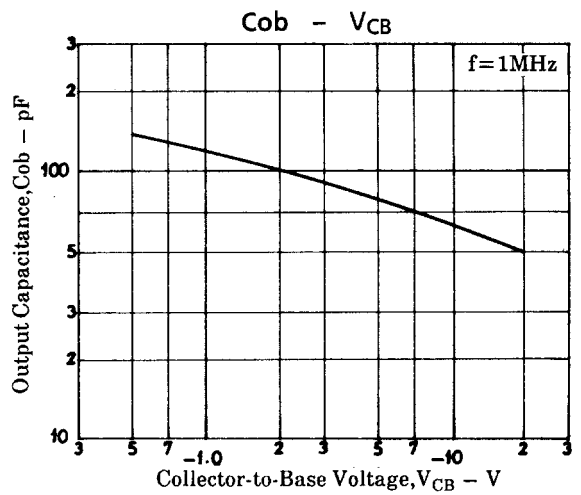
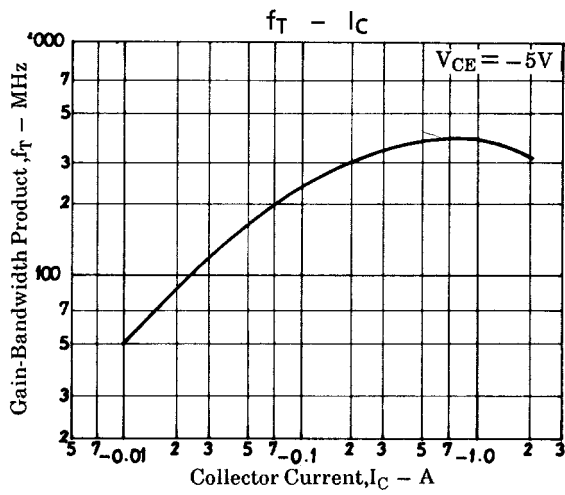
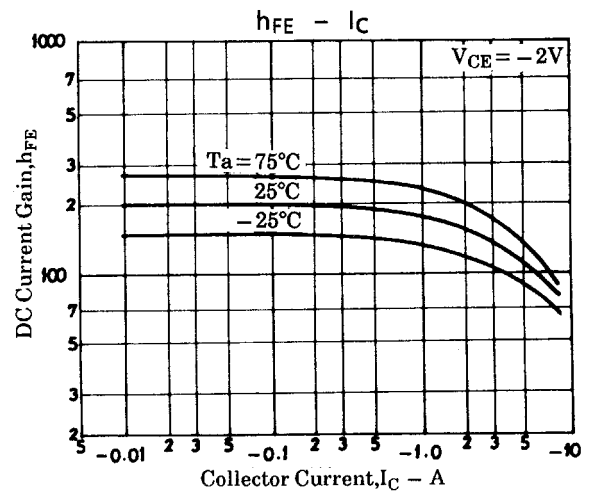
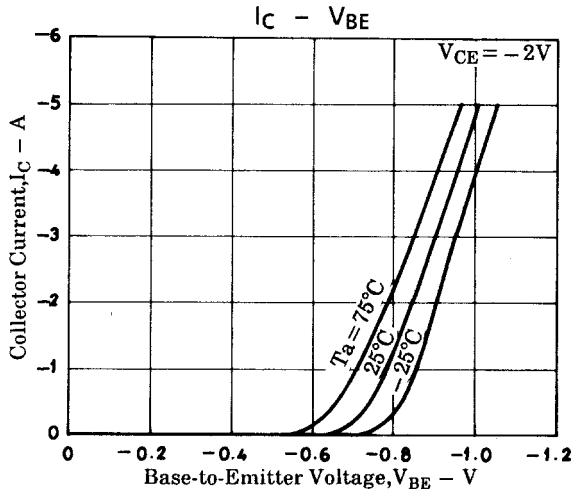
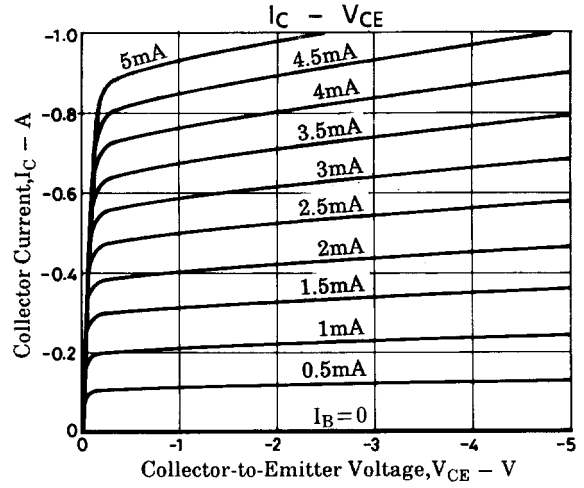
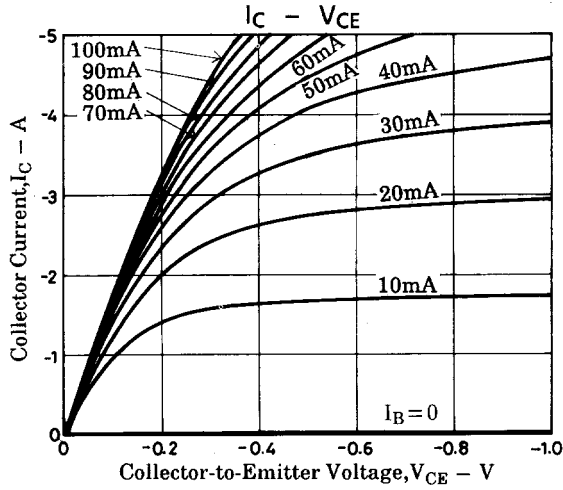

FX501

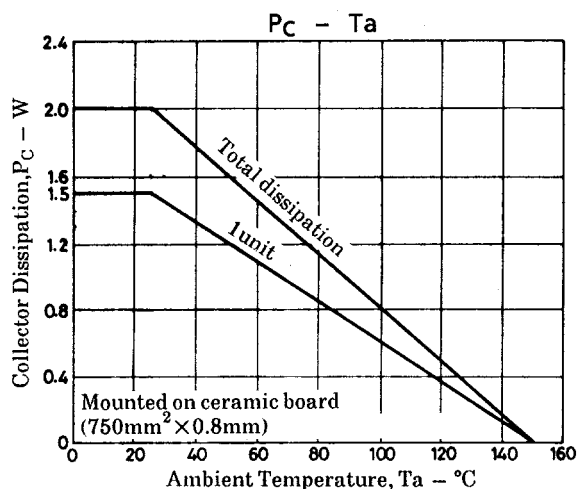
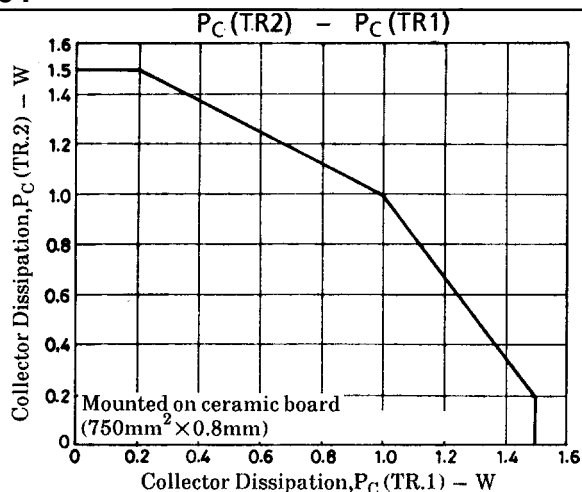
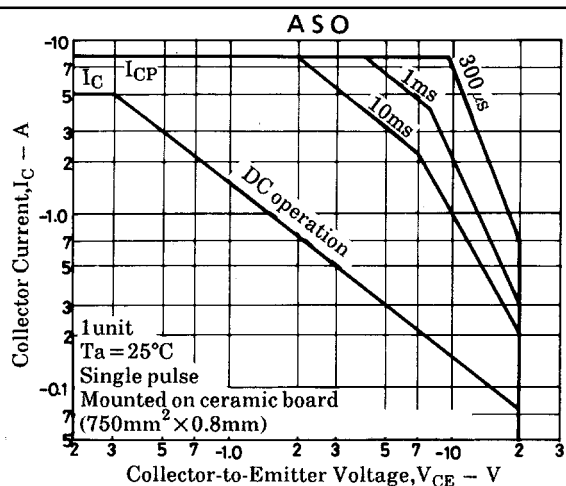

■ No products described or contained herein are intended for use in surgical implants, life-support systems, aerospace equipment, nuclear power control systems, vehicles, disaster/crime-prevention equipment and the like, the failure of which may directly or indirectly cause injury, death or property loss.

■ Anyone purchasing any products described or contained herein for an above-mentioned use shall:

- ① Accept full responsibility and indemnify and defend SANYO ELECTRIC CO., LTD., its affiliates, subsidiaries and distributors and all their officers and employees, jointly and severally, against any and all claims and litigation and all damages, cost and expenses associated with such use:
- ② Not impose any responsibility for any fault or negligence which may be cited in any such claim or litigation on SANYO ELECTRIC CO., LTD., its affiliates, subsidiaries and distributors or any of their officers and employees jointly or severally.

■ Information (including circuit diagrams and circuit parameters) herein is for example only; it is not guaranteed for volume production. SANYO believes information herein is accurate and reliable, but no guarantees are made or implied regarding its use or any infringements of intellectual property rights or other rights of third parties.

This catalog provides information as of May, 1998. Specifications and information herein are subject to change without notice.