

# FS7KM-14A

HIGH-SPEED SWITCHING USE

## FS7KM-14A



- $V_{DSS}$  ..... 700V
- $r_{DS(ON)}$  (MAX) .....  $1.82\Omega$
- $I_D$  ..... 7A
- $V_{iso}$  ..... 2000V

## OUTLINE DRAWING

Dimensions in mm

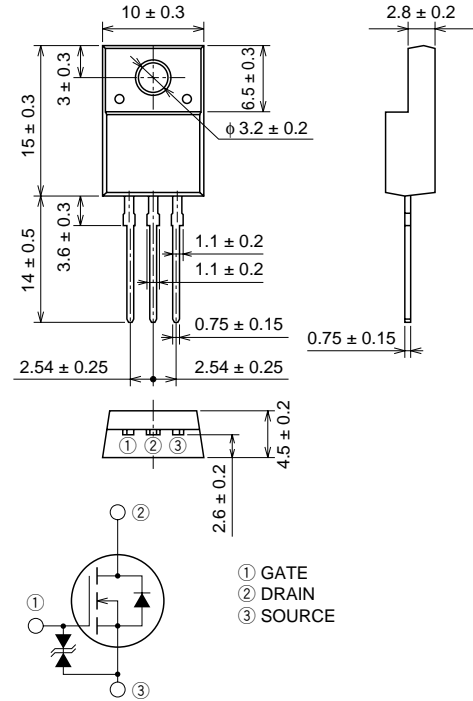

TO-220FN

## APPLICATION

SMPS, DC-DC Converter, battery charger, power supply of printer, copier, HDD, FDD, TV, VCR, personal computer etc.

## MAXIMUM RATINGS (T<sub>c</sub> = 25°C)

Symbol	Parameter	Conditions	Ratings	Unit
$V_{DSS}$	Drain-source voltage	$V_{GS} = 0V$	700	V
$V_{GSS}$	Gate-source voltage	$V_{DS} = 0V$	$\pm 30$	V
$I_D$	Drain current		7	A
$I_{DM}$	Drain current (Pulsed)		21	A
$P_D$	Maximum power dissipation		30	W
$T_{ch}$	Channel temperature		-55 ~ +150	°C
$T_{stg}$	Storage temperature		-55 ~ +150	°C
$V_{iso}$	Isolation voltage	AC for 1 minute, Terminal to case	2000	V <sub>rms</sub>
—	Weight	Typical value	2	g

**ELECTRICAL CHARACTERISTICS** (Tch = 25°C)

Symbol	Parameter	Test conditions	Limits			Unit
			Min.	Typ.	Max.	
V (BR) DSS	Drain-source breakdown voltage	Id = 1mA, VGS = 0V	700	—	—	V
V (BR) GSS	Gate-source breakdown voltage	IGS = ±100μA, VDS = 0V	±30	—	—	V
IGSS	Gate-source leakage current	VGS = ±25V, VDS = 0V	—	—	±10	μA
IdSS	Drain-source leakage current	VDS = 700V, VGS = 0V	—	—	1	mA
VGS (th)	Gate-source threshold voltage	Id = 1mA, VDS = 10V	2	3	4	V
rDS (ON)	Drain-source on-state resistance	Id = 3A, VGS = 10V	—	1.40	1.82	Ω
VDS (ON)	Drain-source on-state voltage	Id = 3A, VGS = 10V	—	4.20	5.46	V
yfs	Forward transfer admittance	Id = 3A, VDS = 10V	3.6	6.0	—	S
Ciss	Input capacitance	VDS = 25V, VGS = 0V, f = 1MHz	—	1050	—	pF
Coss	Output capacitance		—	100	—	pF
Crss	Reverse transfer capacitance		—	24	—	pF
td (on)	Turn-on delay time	VDD = 200V, Id = 3A, VGS = 10V, RGEN = RGS = 50Ω	—	20	—	ns
tr	Rise time		—	22	—	ns
td (off)	Turn-off delay time		—	110	—	ns
tf	Fall time		—	35	—	ns
VSD	Source-drain voltage	IS = 3A, VGS = 0V	—	1.0	1.5	V
Rth (ch-c)	Thermal resistance	Channel to case	—	—	4.17	°C/W

**PERFORMANCE CURVES**

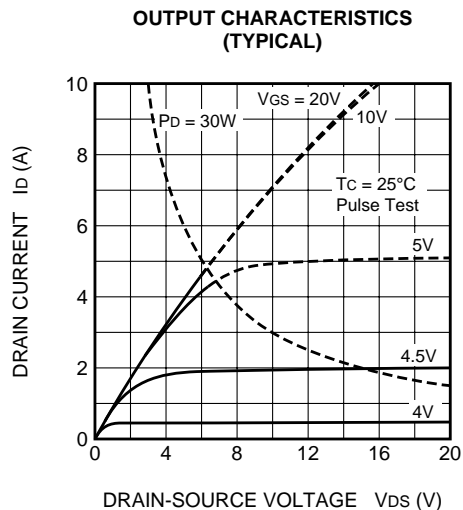
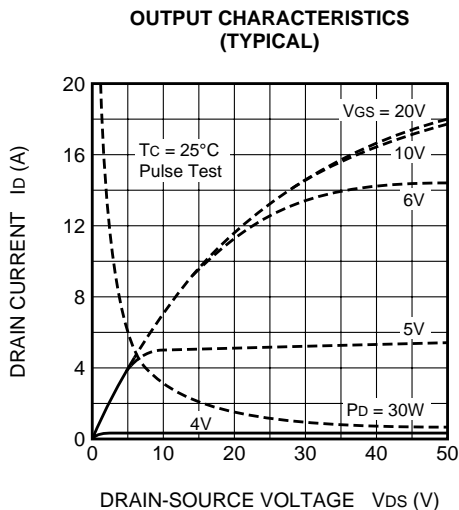
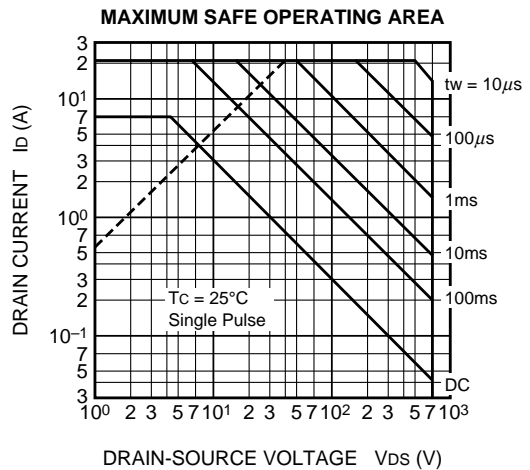
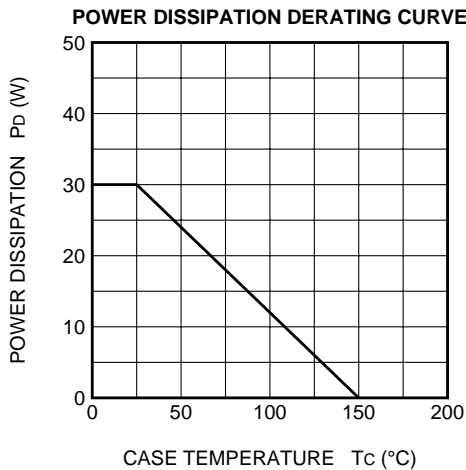

# FS7KM-14A

HIGH-SPEED SWITCHING USE

**ON-STATE VOLTAGE VS. GATE-SOURCE VOLTAGE (TYPICAL)**

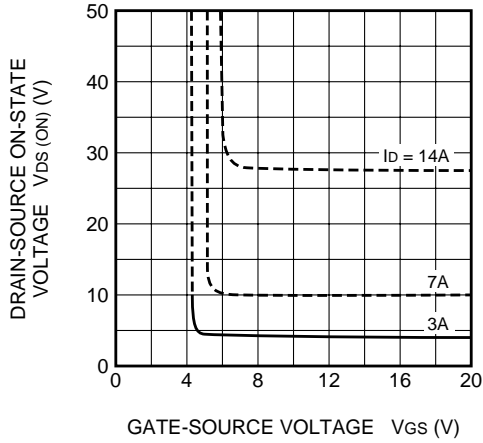

**ON-STATE RESISTANCE VS. DRAIN CURRENT (TYPICAL)**

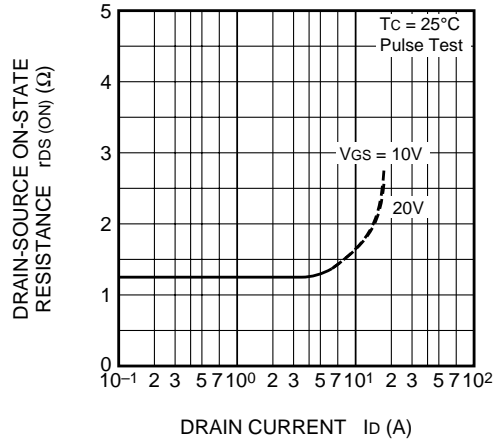

**TRANSFER CHARACTERISTICS (TYPICAL)**

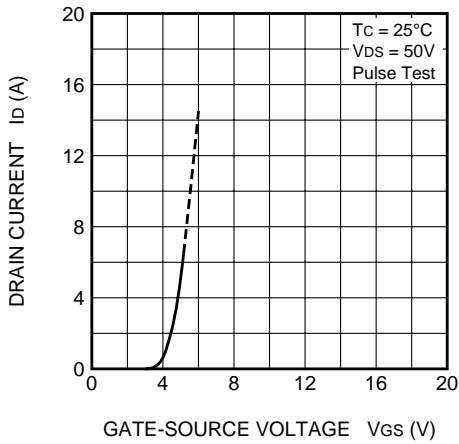

**FORWARD TRANSFER ADMITTANCE VS. DRAIN CURRENT (TYPICAL)**

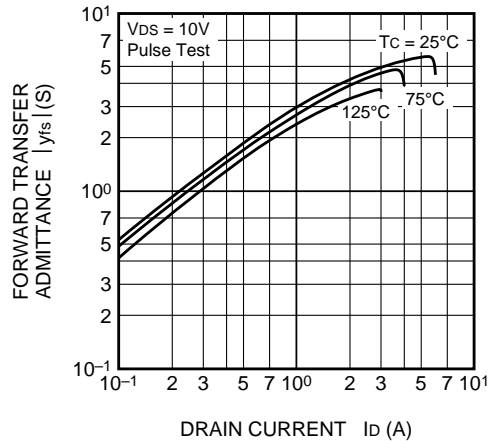

**CAPACITANCE VS. DRAIN-SOURCE VOLTAGE (TYPICAL)**

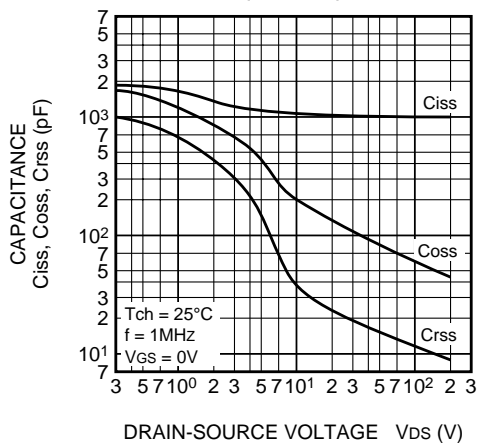

**SWITCHING CHARACTERISTICS (TYPICAL)**

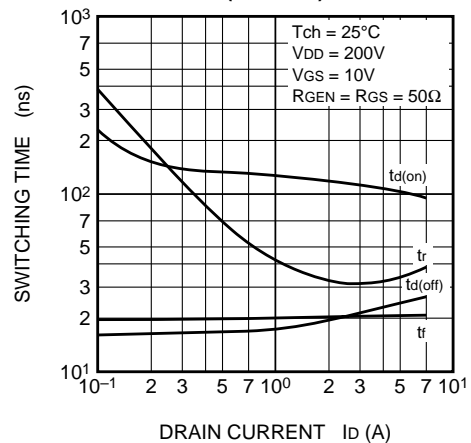

GATE-SOURCE VOLTAGE VS. GATE CHARGE (TYPICAL)

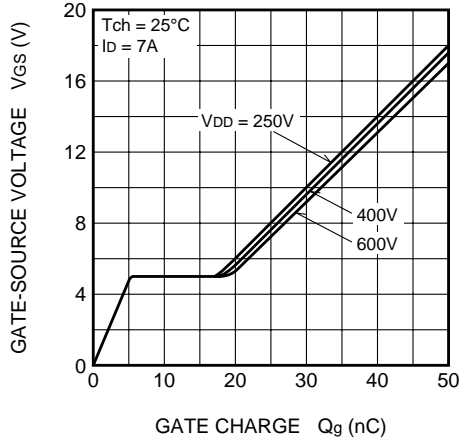

SOURCE-DRAIN DIODE FORWARD CHARACTERISTICS (TYPICAL)

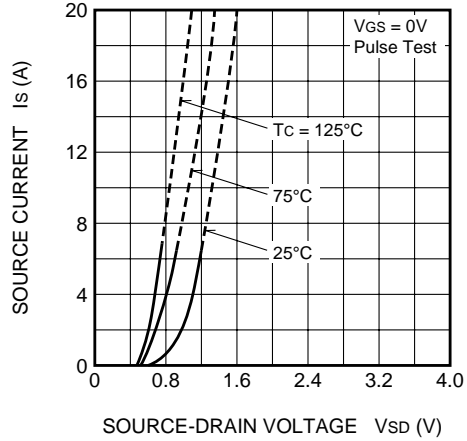

ON-STATE RESISTANCE VS. CHANNEL TEMPERATURE (TYPICAL)

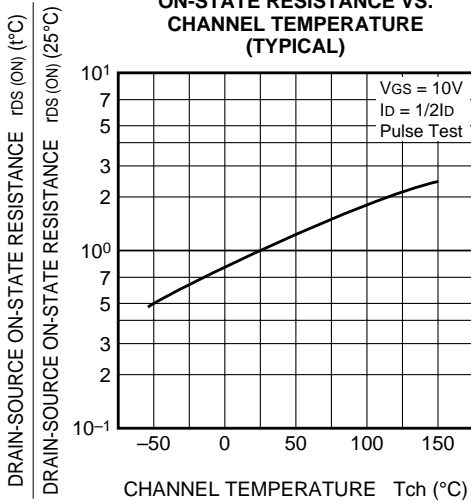

THRESHOLD VOLTAGE VS. CHANNEL TEMPERATURE (TYPICAL)

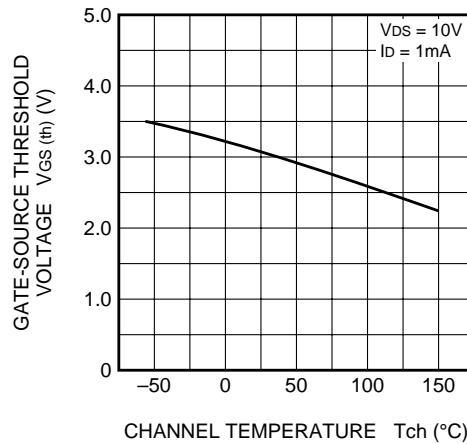

BREAKDOWN VOLTAGE VS. CHANNEL TEMPERATURE (TYPICAL)

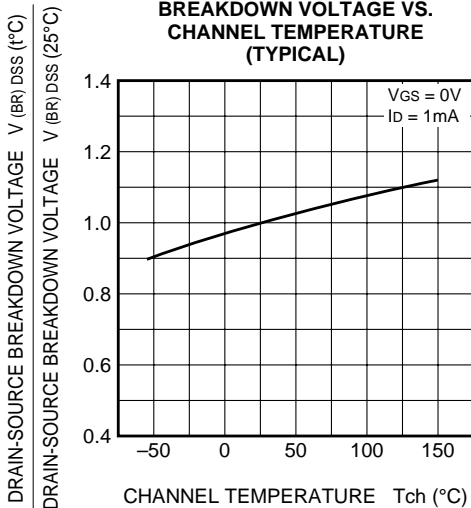

TRANSIENT THERMAL IMPEDANCE CHARACTERISTICS

