

# FS5UM-16A

HIGH-SPEED SWITCHING USE

## FS5UM-16A



- V<sub>DSS</sub> ..... 800V
- r<sub>DS (ON)</sub> (MAX) ..... 2.3Ω
- I<sub>D</sub> ..... 5A

## OUTLINE DRAWING

Dimensions in mm

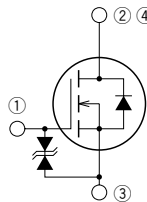
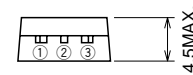
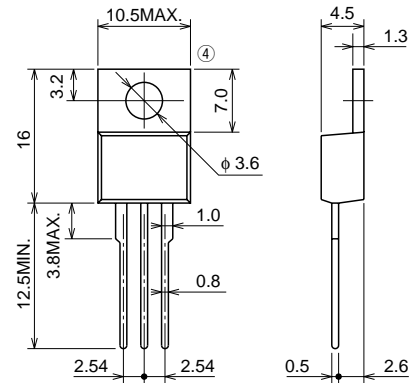

- ① GATE
- ② DRAIN
- ③ SOURCE
- ④ DRAIN

TO-220

## APPLICATION

SMPS, DC-DC Converter, battery charger, power supply of printer, copier, HDD, FDD, TV, VCR, personal computer etc.

## MAXIMUM RATINGS (T<sub>c</sub> = 25°C)

Symbol	Parameter	Conditions	Ratings	Unit
V <sub>DSS</sub>	Drain-source voltage	V <sub>GS</sub> = 0V	800	V
V <sub>GSS</sub>	Gate-source voltage	V <sub>DS</sub> = 0V	±30	V
I <sub>D</sub>	Drain current		5	A
I <sub>DM</sub>	Drain current (Pulsed)		15	A
P <sub>D</sub>	Maximum power dissipation		125	W
T <sub>ch</sub>	Channel temperature		-55 ~ +150	°C
T <sub>stg</sub>	Storage temperature		-55 ~ +150	°C
—	Weight	Typical value	2	g

# FS5UM-16A

HIGH-SPEED SWITCHING USE

## ELECTRICAL CHARACTERISTICS (T<sub>ch</sub> = 25°C)

Symbol	Parameter	Test conditions	Limits			Unit
			Min.	Typ.	Max.	
V (BR) DSS	Drain-source breakdown voltage	I <sub>D</sub> = 1mA, V <sub>GS</sub> = 0V	800	—	—	V
V (BR) GSS	Gate-source breakdown voltage	I <sub>GS</sub> = ±100μA, V <sub>DS</sub> = 0V	±30	—	—	V
I <sub>GSS</sub>	Gate-source leakage current	V <sub>GS</sub> = ±25V, V <sub>DS</sub> = 0V	—	—	±10	μA
I <sub>DSS</sub>	Drain-source leakage current	V <sub>DS</sub> = 800V, V <sub>GS</sub> = 0V	—	—	1	mA
V <sub>GS</sub> (th)	Gate-source threshold voltage	I <sub>D</sub> = 1mA, V <sub>DS</sub> = 10V	2	3	4	V
r <sub>DS</sub> (ON)	Drain-source on-state resistance	I <sub>D</sub> = 2A, V <sub>GS</sub> = 10V	—	1.76	2.30	Ω
V <sub>DS</sub> (ON)	Drain-source on-state voltage	I <sub>D</sub> = 2A, V <sub>GS</sub> = 10V	—	3.52	4.60	V
y <sub>fs</sub>	Forward transfer admittance	I <sub>D</sub> = 2A, V <sub>DS</sub> = 10V	3.0	5.0	—	S
C <sub>iss</sub>	Input capacitance	V <sub>DS</sub> = 25V, V <sub>GS</sub> = 0V, f = 1MHz	—	1050	—	pF
C <sub>oss</sub>	Output capacitance		—	100	—	pF
C <sub>rss</sub>	Reverse transfer capacitance		—	20	—	pF
t <sub>d</sub> (on)	Turn-on delay time	V <sub>DD</sub> = 200V, I <sub>D</sub> = 2A, V <sub>GS</sub> = 10V, R <sub>GEN</sub> = R <sub>GS</sub> = 50Ω	—	20	—	ns
t <sub>r</sub>	Rise time		—	18	—	ns
t <sub>d</sub> (off)	Turn-off delay time		—	110	—	ns
t <sub>f</sub>	Fall time		—	35	—	ns
V <sub>SD</sub>	Source-drain voltage	I <sub>S</sub> = 2A, V <sub>GS</sub> = 0V	—	1.0	1.5	V
R <sub>th</sub> (ch-c)	Thermal resistance	Channel to case	—	—	1.0	°C/W

## PERFORMANCE CURVES

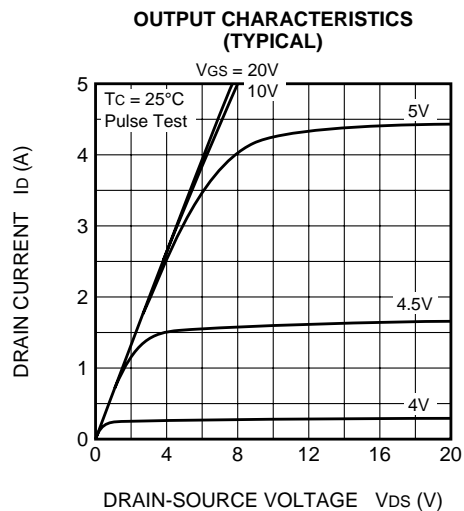
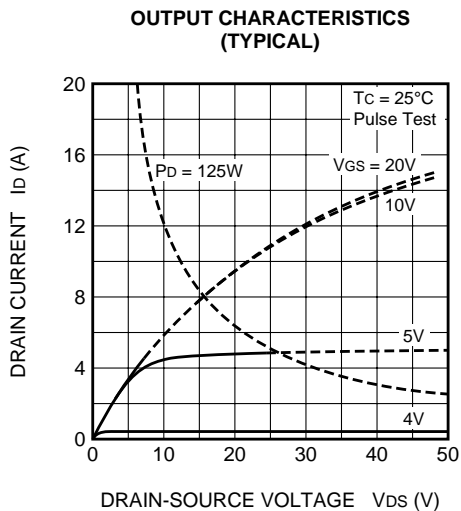
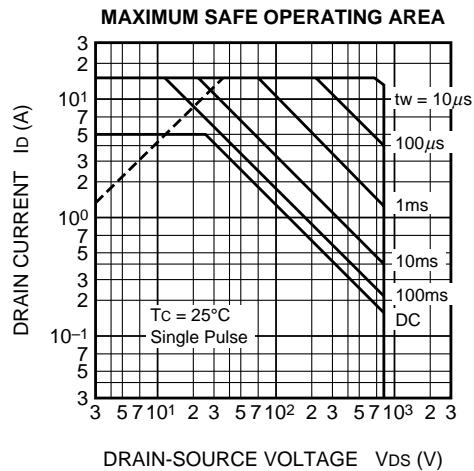
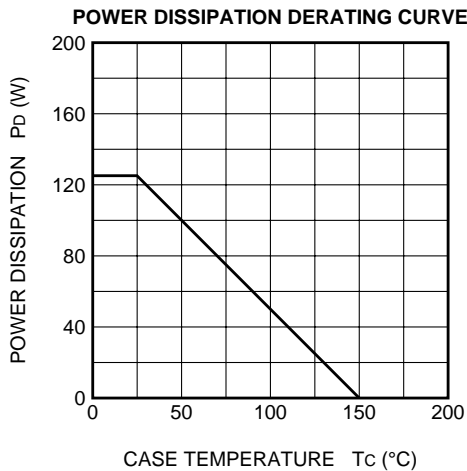

# FS5UM-16A

HIGH-SPEED SWITCHING USE

**ON-STATE VOLTAGE VS. GATE-SOURCE VOLTAGE (TYPICAL)**

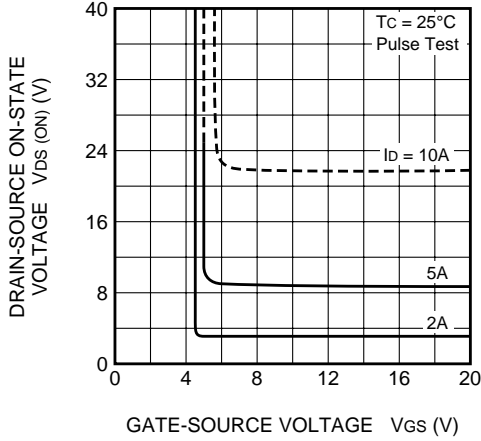

**ON-STATE RESISTANCE VS. DRAIN CURRENT (TYPICAL)**

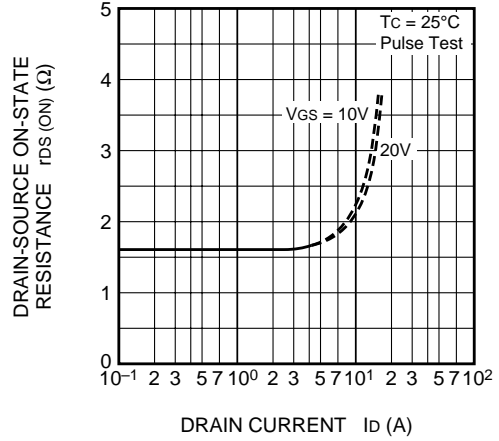

**TRANSFER CHARACTERISTICS (TYPICAL)**

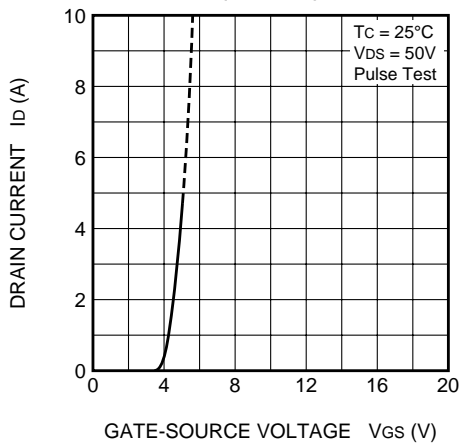

**FORWARD TRANSFER ADMITTANCE VS. DRAIN CURRENT (TYPICAL)**

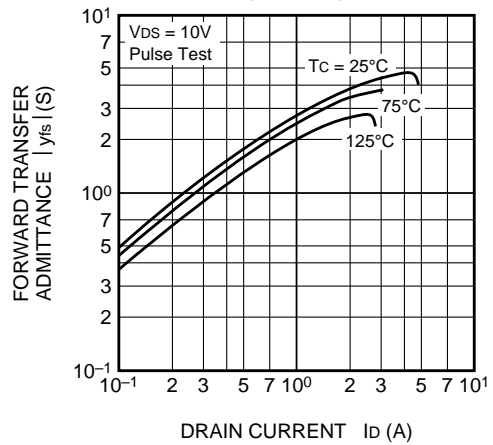

**CAPACITANCE VS. DRAIN-SOURCE VOLTAGE (TYPICAL)**

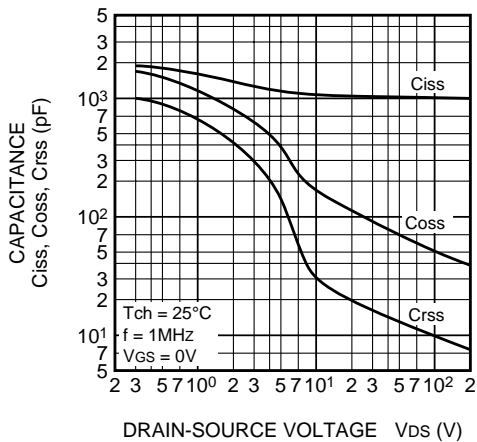

**SWITCHING CHARACTERISTICS (TYPICAL)**

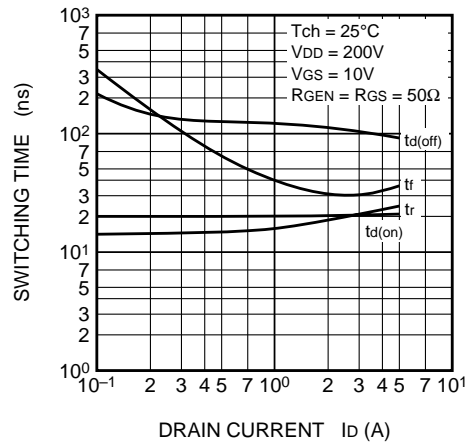

**GATE-SOURCE VOLTAGE VS. GATE CHARGE (TYPICAL)**

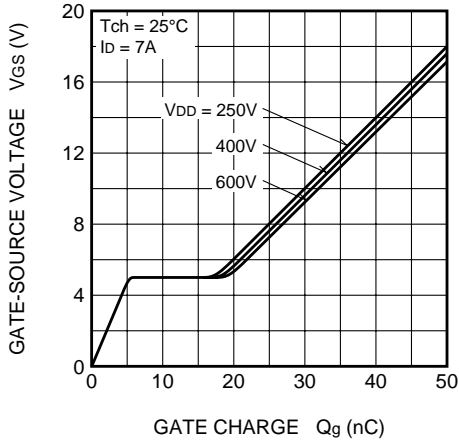

**SOURCE-DRAIN DIODE FORWARD CHARACTERISTICS (TYPICAL)**

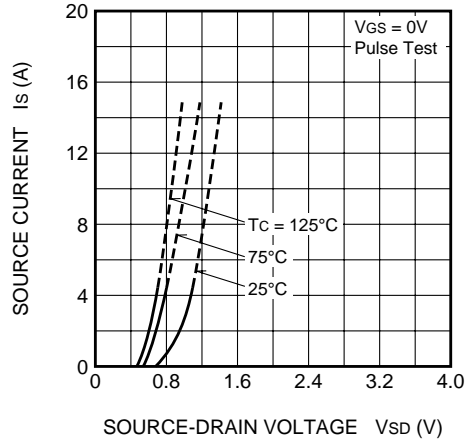

**ON-STATE RESISTANCE VS. CHANNEL TEMPERATURE (TYPICAL)**

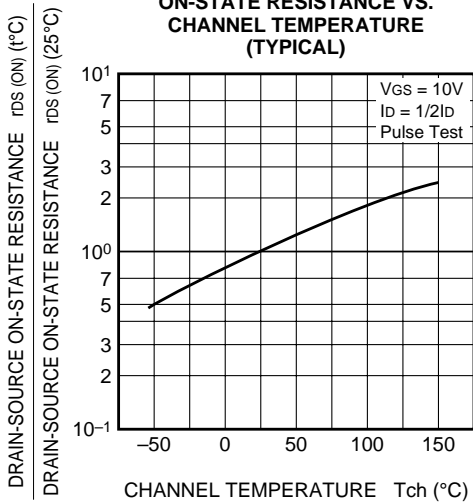

**THRESHOLD VOLTAGE VS. CHANNEL TEMPERATURE (TYPICAL)**

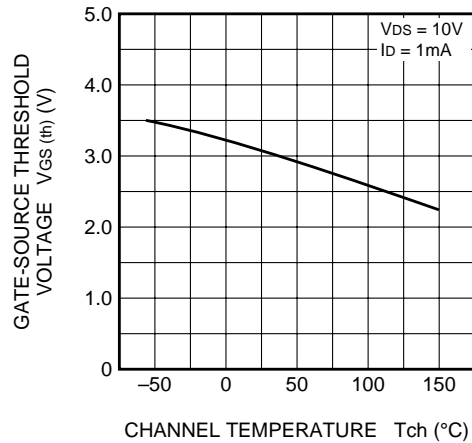

**BREAKDOWN VOLTAGE VS. CHANNEL TEMPERATURE (TYPICAL)**

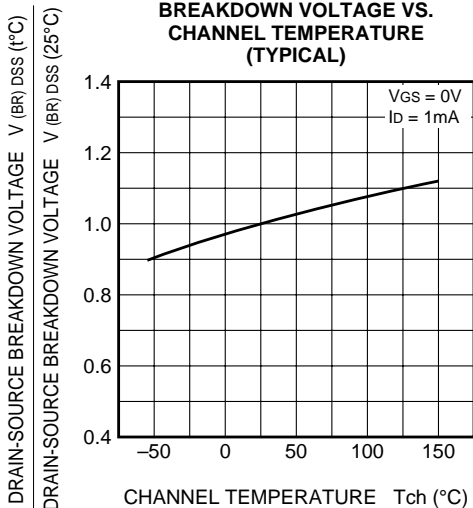

**TRANSIENT THERMAL IMPEDANCE CHARACTERISTICS**

