



FS1A THRU FS1M

Features

- For Surface Mount Applications
- Extremely Low Thermal Resistance
- Easy Pick And Place
- High Temp Soldering: 250°C for 10 Seconds At Terminals
- Superfast Recovery Times For High Efficiency

Maximum Ratings

- Operating Temperature: -50°C to +150°C
- Storage Temperature: -50°C to +150°C
- Maximum Thermal Resistance; 15°C/W Junction To Lead

Catalog Number	Device Marking	Maximum Recurrent Peak Reverse Voltage	Maximum RMS Voltage	Maximum DC Blocking Voltage
FS1A	FS1A	50V	35V	50V
FS1B	FS1B	100V	70V	100V
FS1D	FS1D	200V	140V	200V
FS1G	FS1G	400V	280V	400V
FS1J	FS1J	600V	420V	600V
FS1K	FS1K	800V	560V	800V
FS1M	FS1M	1000V	700V	1000V

Electrical Characteristics @ 25°C Unless Otherwise Specified

Average Forward current	$I_{F(AV)}$	1.0A	$T_J = 90^\circ\text{C}$
Peak Forward Surge Current	I_{FSM}	30A	8.3ms, half sine
Maximum Instantaneous Forward Voltage	V_F	1.30V	$I_{FM} = 1.0\text{A}; T_J = 25^\circ\text{C}^*$
Maximum DC Reverse Current At Rated DC Blocking Voltage	I_R	5 μA 200 μA	$T_J = 25^\circ\text{C}$ $T_J = 125^\circ\text{C}$
Maximum Reverse Recovery Time	T_{rr}	150ns 250ns 500ns	$I_F=0.5\text{A}, I_R=1.0\text{A}, I_{rr}=0.25\text{A}$
Typical Junction Capacitance	C_J	50pF	Measured at 1.0MHz, $V_R=4.0\text{V}$

*Pulse test: Pulse width 200 μsec , Duty cycle 2%

1 Amp Fast Recovery Silicon Rectifier 50 to 1000 Volts

DO-214AC (SMA)

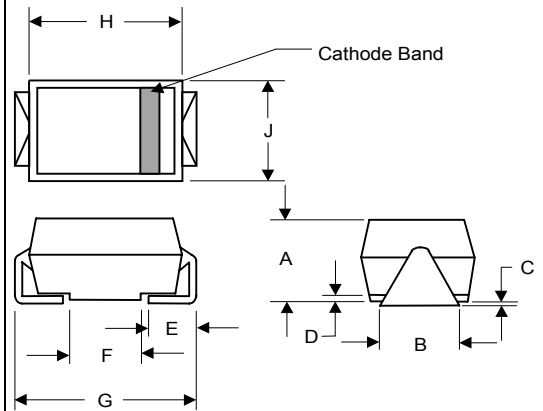

DIM	INCHES		MM		NOTE
	MIN	MAX	MIN	MAX	
A	.078	.103	1.98	2.62	
B	.050	.064	1.27	1.63	
C	.002	.008	.05	.20	
D	---	.02	---	.51	
E	.030	.060	.76	1.52	
F	.065	.096	1.65	2.45	
G	.189	.220	4.80	5.59	
H	.157	.181	3.99	4.60	
J	.090	.115	2.25	2.92	

SUGGESTED SOLDER PAD LAYOUT

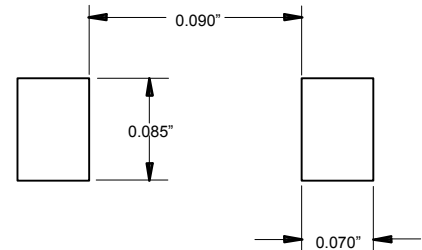



FS1A thru FS1M

Figure 1
Typical Forward Characteristics

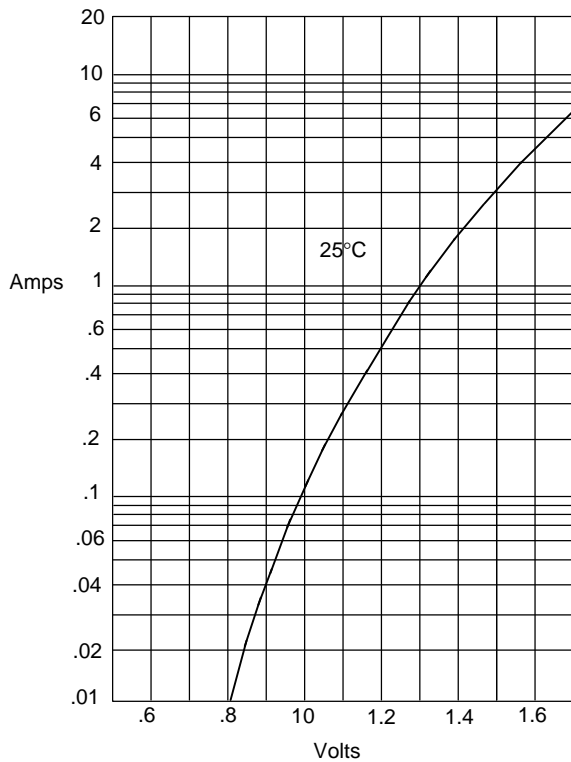

Instantaneous Forward Current - Amperes *versus*
Instantaneous Forward Voltage - Volts

Figure 2
Forward Derating Curve

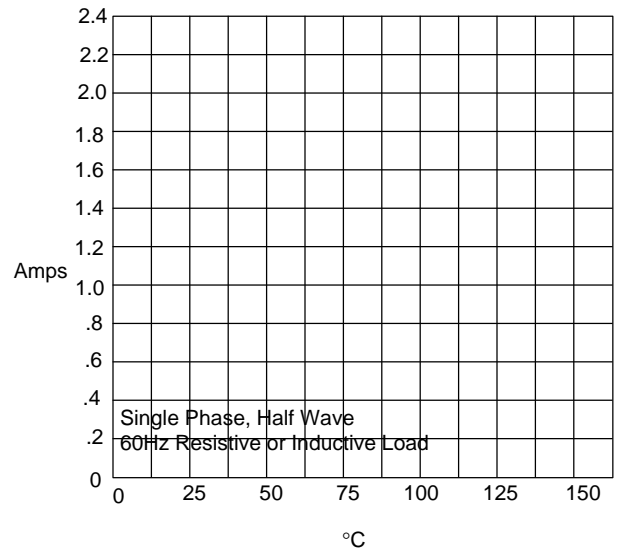

Average Forward Rectified Current - Amperes *versus*
Ambient Temperature - °C

Figure 3
Junction Capacitance

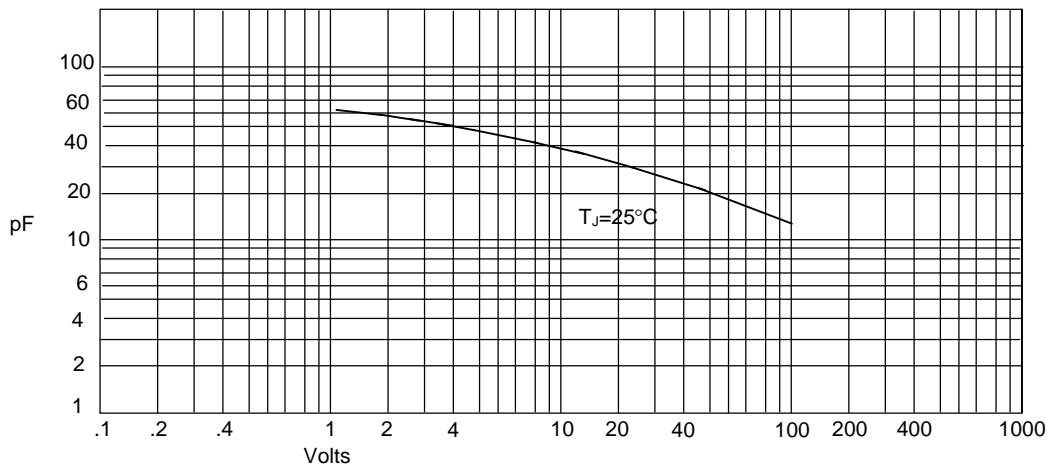

Junction Capacitance - pF *versus*
Reverse Voltage - Volts

FS1A thru FS1M

Figure 4
Peak Forward Surge Current

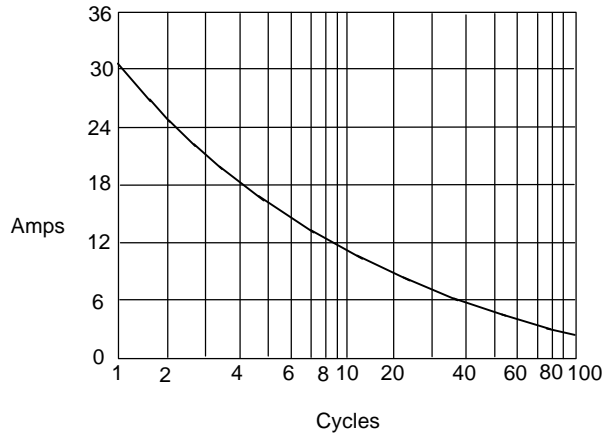

Peak Forward Surge Current - Amperes versus
Number Of Cycles At 60Hz - Cycles

Figure 5
New SMA Assembly

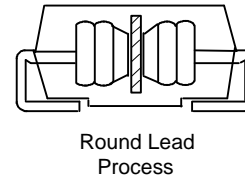
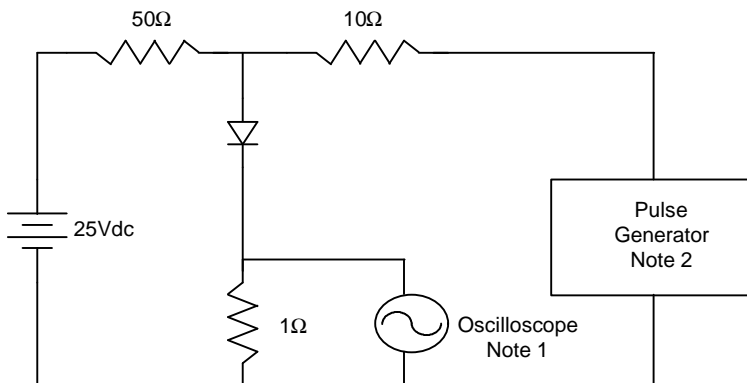

Figure 6
Reverse Recovery Time Characteristic And Test Circuit Diagram



Notes:

1. Rise Time = 7ns max.
Input impedance = 1 megohm, 22pF
2. Rise Time = 10ns max.
Source impedance = 50 ohms
3. Resistors are non-inductive

