

2A SMD SCHOTTKY BARRIER RECTIFIERS, 20V-200V

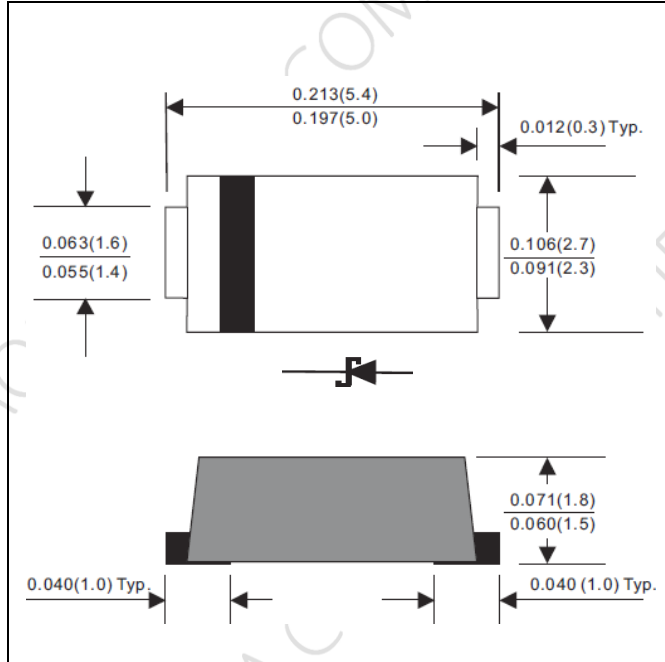

PRODUCT FEATURES

1. FLAMMABILITY CLASSIFICATION 94V-0
2. EXCELLENT REVERSE LEAKAGE CURRENT AND THERMAL RESISTANCE
3. HIGH CURRENT CAPABILITY, LOW POWER LOSS
4. SILICON EPITAXIAL PLANAR CHIP, METAL SILICON JUNCTION
5. GUARDRING FOR OVERVOLTAGE PROTECTION
6. CASE: TRANSFER MOLDED, DO-214AC (SMA-S)
7. DIMENSIONS IN INCHES AND (MILLIMETERS)
8. LEADS: SOLDERABILITY PER MIL-STD-750 METHOD 2026
9. WEIGHT: 0.05 GRAMS
10. RoHS COMPLIANT, ADD SUFFIX "H" FOR HALOGEN FREE
i.e. FM220-S-H: RoHS COMPLIANT/HALOGEN FREE

ELECTRICAL CHARACTERISTICS

MAXIMUM RATINGS ($T_A = 25^\circ\text{C}$ UNLESS OTHERWISE NOTED) AND ELECTRICAL CHARACTERISTICS

RATING	SYMBOL		UNITS
MAXIMUM FORWARD RECTIFIED CURRENT	I_o	2	A
PEAK FORWARD SURGE CURRENT, 8.3ms SINGLE HALF SINE-WAVE SUPERIMPOSED ON RATED LOAD	I_{FSM}	50	A
TYPICAL JUNCTION CAPACITANCE BETWEEN TERMINALS (NOTE 1)	C_J	160	pF
STORAGE TEMPERATURE RANGE	T_{STG}	- 65 TO +175	$^\circ\text{C}$
OPERATING JUNCTION TEMPERATURE RANGE (NOTE 2)	T_J	- 55 TO +150	$^\circ\text{C}$
MAX. DC REVERSE CURRENT AT RATED DC BLOCKING VOLTAGE $T_J = 25^\circ\text{C}$	I_R	0.5	mA
MAX. DC REVERSE CURRENT AT RATED DC BLOCKING VOLTAGE $T_J = 100^\circ\text{C}$	I_R	10	mA
TYPICAL THERMAL RESISTANCE	$R_{\theta JA}$	64	$^\circ\text{C}/\text{W}$
	$R_{\theta JC}$	32	$^\circ\text{C}/\text{W}$

PART NUMBER	MAX RECURRENT PK REVERSE VOLTAGE/DC BLOCKING V_{RRM}/V_R (V)	MAX V_{RMS} (V)	TYPICAL FORWARD VOLTAGE AT $I_F = 2A$ V_F (V)	MARKING
FM220-S	20	14	0.50	SK22
FM230-S	30	21	0.50	SK23
FM240-S	40	28	0.50	SK24
FM250-S	50	35	0.70	SK25
FM260-S	60	42	0.70	SK26
FM280-S	80	56	0.85	SK28
FM2100-S	100	70	0.85	S210
FM2150-S	150	105	0.90	S215
FM2200-S	200	140	0.92	S220

NOTE : 1. MEASURE AT 1MHz WITH 4VDC REVERSE VOLTAGE APPLIED .

2. FOR THE FM220-S, FM230-S, AND FM240-S, THE OPERATING JUNCTION TEMPERATURE RANGE IS FROM -55 TO +125 $^\circ\text{C}$



3. CURRENT RATING IS BASED ON SINGLE PHASE, 1/2 WAVE, 60HZ, RESISTIVE, OR INDUCTIVE LOAD. FOR CAPACITIVE LOAD, DERATE CURRENT BY 20%.

RATINGS AND CHARACTERISTIC CURVES

FIG.1-TYPICAL FORWARD CURRENT DERATING CURVE

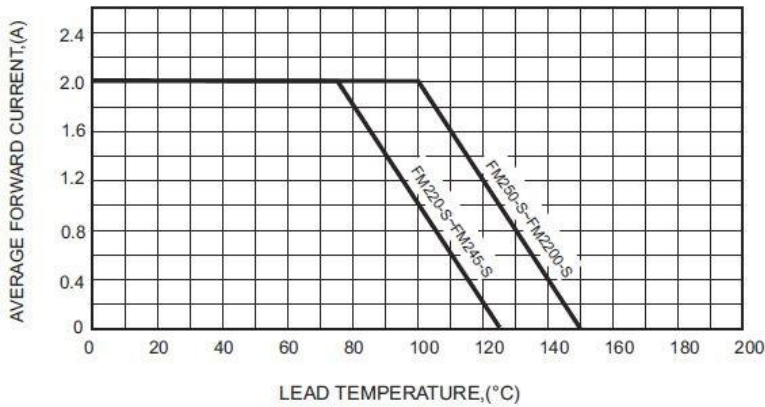

FIG.2-TYPICAL FORWARD CHARACTERISTICS

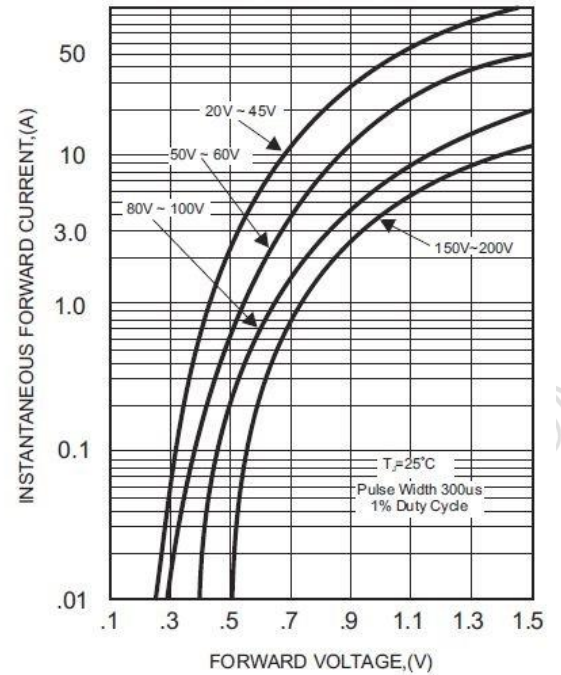

FIG.3-MAXIMUM NON-REPETITIVE FORWARD SURGE CURRENT

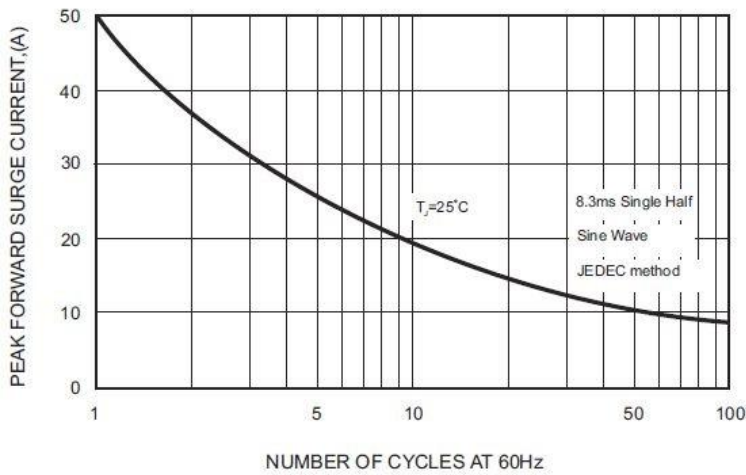

FIG.4-TYPICAL JUNCTION CAPACITANCE

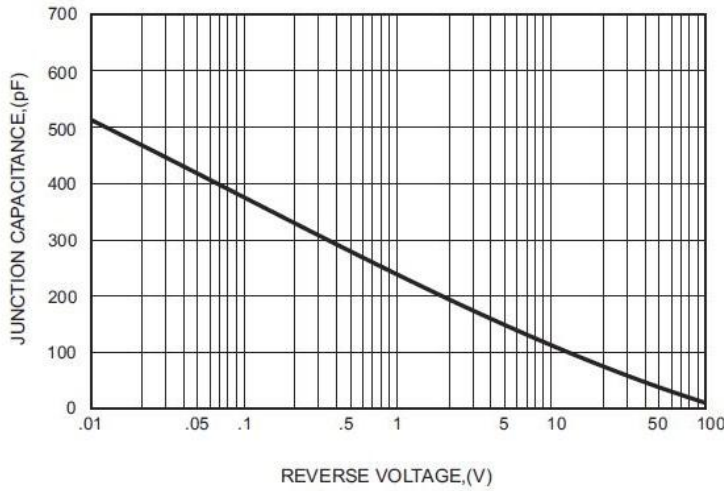
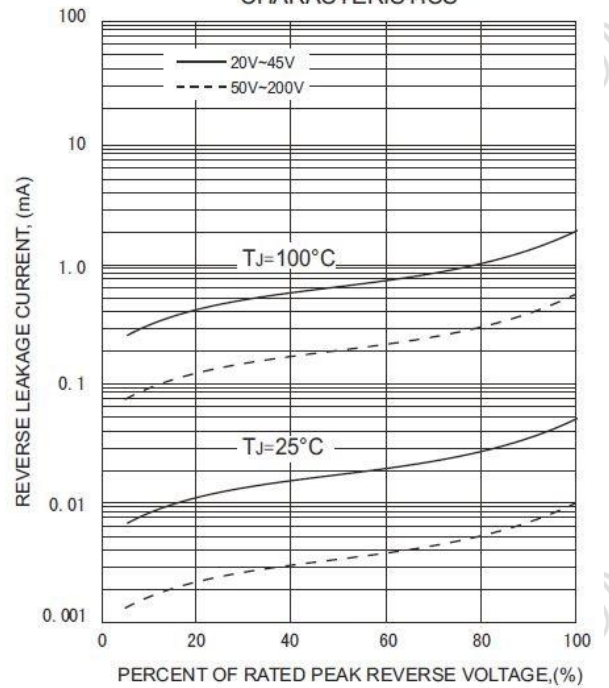
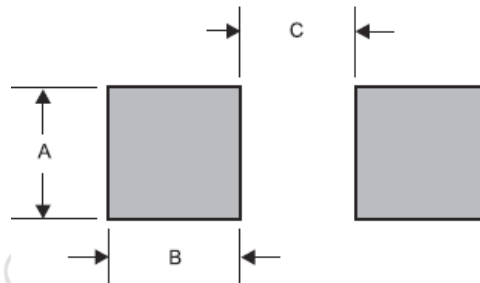

FIG.5 - TYPICAL REVERSE CHARACTERISTICS



LAYOUT RECOMMENDATION



PACKAGE	A	B	C
SMA-S	0.063 (1.60)	0.059 (1.50)	0.110 (2.80)