

*ASSP Mobile Communication Systems***Piezoelectric SAW BPF
(700 to 1000 MHz)****F5CE Series (D2 type)****DESCRIPTION**

The F5CE-D2 series of SAW bandpass filters apply to the frequency range 700 to 1000 MHz. These filters make it possible to provide high stopband attenuation and excellent passband flatness due to using unique DMS (Double Mode SAW) technology as design method. Moreover, these filters are provided in small 3.0 mm sq. package. This contributes to reduce weight and size of mobile communication units.

The F5CE-D2 series of SAW filters are suitable for interstage RF filter in mobile communication systems in the frequency range 700 to 1000 MHz. Standard devices are available for AMPS/CDMA/TDMA, GSM, PDC800 and ISM900.

FEATURES

- Excellent stopband attenuation
- Low insertion loss and low passband ripple
- Ultra compact and light package (3.0 mm sq.)
- External matching circuits are not required. (50 ohms I/O)
- Surface mount package (SMT)
- Standard devices are available for mobile communication standards (AMPS/CDMA/TDMA, GSM, PDC800 and ISM900)

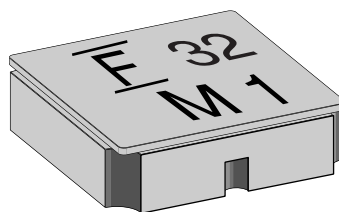
PACKAGE

F5CE Series (D2 type)

■ PIN ASSIGNMENT

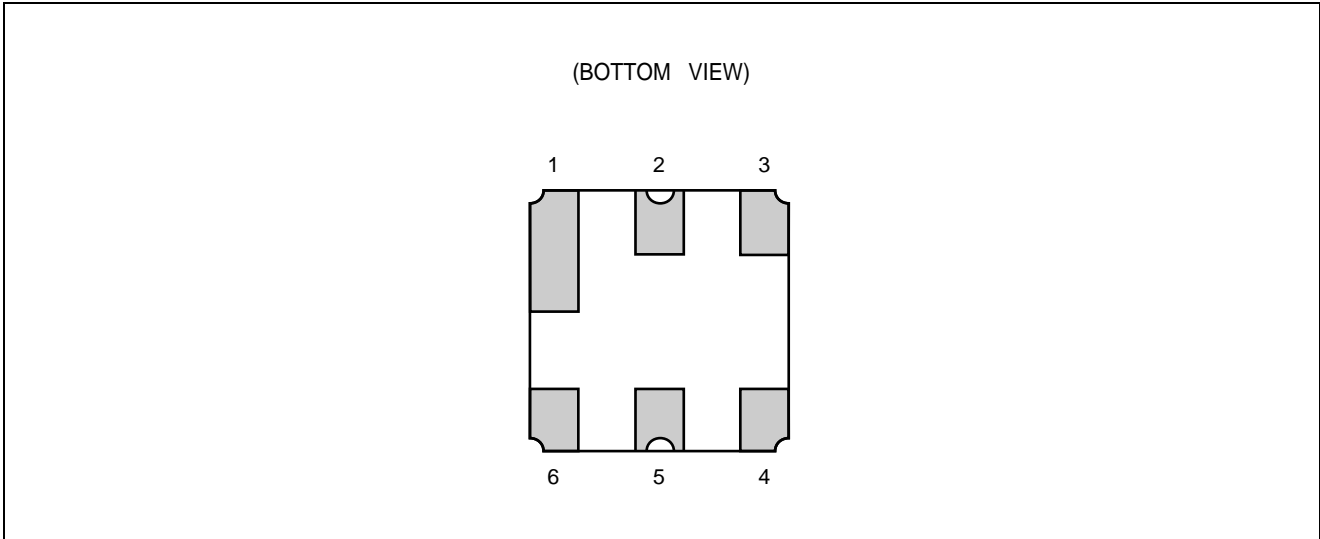

■ PIN DESCRIPTION

Pin no.	Pin name	Description
1	GND	Ground Pin
2	IN	Input Pin
3	GND	Ground Pin
4	GND	Ground Pin
5	OUT	Output Pin
6	GND	Ground Pin

■ ABSOLUTE MAXIMUM RATINGS

Parameter	Symbol	Rating		Unit
		Min.	Max.	
Operating temperature	Ta	-30	+85	°C
Storage temperature	Tstg	-40	+100	°C
Input power	P _{IN}	-	+15	dBm
Input DC voltage	DC	-5	+5	V

WARNING: Piezoelectric devices can be permanently damaged by application of stress (voltage, power, temperature, etc.) in excess of absolute maximum ratings. Do not exceed these ratings.

F5CE Series (D2 type)

■ RECOMMENDED OPERATING CONDITION

Parameter	Symbol	Value		Unit
		Min.	Max.	
Operating temperature	Ta	-30	+85	°C

WARNING: Recommended operating conditions are normal operating ranges for the piezoelectric device. All the device's electrical characteristics are warranted when operated within these ranges.

Always use piezoelectric devices within the recommended operating conditions. Operation outside these ranges may adversely affect reliability and could result in device failure.

No warranty is made with respect to uses, operating conditions, or combinations not represented on the data sheet. Users considering application outside the listed conditions are advised to contact their FUJITSU representative beforehand.

■ STANDARD FREQUENCIES

System		Center freq. (MHz)	B/W (MHz)	Part symbol	Part number	Remarks
PDC800	Tx	950.0	20	30	FAR-F5CE-950M00-D230	
	Rx	820.0	20	31	FAR-F5CE-820M00-D231	
AMPS /CDMA /TDMA	Tx	836.5	25	32	FAR-F5CE-836M50-D232	
	Rx	881.5	25	33	FAR-F5CE-881M50-D233	
GSM/NMT	Tx	902.5	25	34	FAR-F5CE-902M50-D234	
	Rx	947.5	25	35	FAR-F5CE-947M50-D235	
ISM900	—	915.0	7	38	FAR-F5CE-915M00-D238	

F5CE Series (D2 type)

■ ELECTRICAL CHARACTERISTICS

1. PDC800 (Tx)

Part number: FAR-F5CE-950M00-D230

(Ta = -30 to +85°C)

Parameter	Symbol	Conditions	Value			Unit	Remarks
			Min.	Typ.	Max.		
Insertion loss	IL	940 to 960 MHz	—	2.6	3.0	dB	
Inband ripple	—	940 to 960 MHz	—	0.7	1.2	dB	
Absolute attenuation	—	DC to 680 MHz	50	66	—	dB	
	—	680 to 696 MHz	50	69	—	dB	
	—	810 to 830 MHz	50	66	—	dB	
	—	1015 to 1106 MHz	35	42	—	dB	
	—	1106 to 1700 MHz	50	59	—	dB	
Inband VSWR	—	940 to 960 MHz	—	1.8	2.0	—	

2. PDC800 (Rx)

Part number: FAR-F5CE-820M00-D231

(Ta = -30 to +85°C)

Parameter	Symbol	Conditions	Value			Unit	Remarks
			Min.	Typ.	Max.		
Insertion loss	IL	810 to 830 MHz	—	2.5	3.0	dB	
Inband ripple	—	810 to 830 MHz	—	0.7	1.2	dB	
Absolute attenuation	—	DC to 760 MHz	50	65	—	dB	
	—	855 to 875 MHz	28	30	—	dB	
	—	875 to 920 MHz	35	38	—	dB	
	—	920 to 1200 MHz	45	60	—	dB	
	—	1200 to 2000 MHz	40	47	—	dB	
Inband VSWR	—	810 to 830 MHz	—	1.7	2.0	—	

F5CE Series (D2 type)

3. AMPS/CDMA/TDMA (Tx)

Part number: FAR-F5CE-836M50-D232

(Ta = -30 to +85°C)

Parameter	Symbol	Conditions	Value			Unit	Remarks
			Min.	Typ.	Max.		
Insertion loss	IL	824 to 849 MHz	—	2.7	3.5	dB	
Inband ripple	—	824 to 849 MHz	—	0.9	1.6	dB	
Absolute attenuation	—	DC to 800 MHz	50	66	—	dB	
	—	869 to 1049 MHz	28	33	—	dB	
	—	1049 to 1200 MHz	50	60	—	dB	
	—	1200 to 2000 MHz	45	50	—	dB	
Inband VSWR	—	824 to 849 MHz	—	1.8	2.0	—	

4. AMPS/CDMA/TDMA (Rx)

Part number: FAR-F5CE-881M50-D233

(Ta = -30 to +85°C)

Parameter	Symbol	Conditions	Value			Unit	Remarks
			Min.	Typ.	Max.		
Insertion loss	IL	869 to 894 MHz	—	2.7	3.5	dB	
Inband ripple	—	869 to 894 MHz	—	0.9	1.6	dB	
Absolute attenuation	—	DC to 779 MHz	50	63	—	dB	
	—	779 to 849 MHz	45	50	—	dB	
	—	914 to 970 MHz	28	33	—	dB	
	—	970 to 1049 MHz	50	60	—	dB	
	—	1049 to 2000 MHz	40	50	—	dB	
Inband VSWR	—	869 to 894 MHz	—	1.7	2.0	—	

F5CE Series (D2 type)

5. GSM/NMT (Tx)

Part number: FAR-F5CE-902M50-D234

(Ta = -30 to +85°C)

Parameter	Symbol	Conditions	Value			Unit	Remarks
			Min.	Typ.	Max.		
Insertion loss	IL	890 to 915 MHz	—	2.8	3.3	dB	
Inband ripple	—	890 to 915 MHz	—	0.8	1.4	dB	
Absolute attenuation	—	DC to 845 MHz	50	60	—	dB	
	—	845 to 870 MHz	45	50	—	dB	
	—	925 to 935 MHz	5	18	—	dB	
	—	935 to 980 MHz	28	33	—	dB	
	—	980 to 1200 MHz	50	60	—	dB	
—	1200 to 3000 MHz	30	40	—	dB		
Inband VSWR	—	890 to 915 MHz	—	1.7	2.1	—	

6. GSM/NMT (Rx)

Part number: FAR-F5CE-947M50-D235

(Ta = -30 to +85°C)

Parameter	Symbol	Conditions	Value			Unit	Remarks
			Min.	Typ.	Max.		
Insertion loss	IL	935 to 960 MHz	—	2.7	3.3	dB	
Inband ripple	—	935 to 960 MHz	—	0.7	1.4	dB	
Absolute attenuation	—	DC to 871 MHz	50	66	—	dB	
	—	890 to 915 MHz	30	40	—	dB	
	—	980 to 1025 MHz	25	34	—	dB	
	—	1025 to 2000 MHz	45	48	—	dB	
	—	2000 to 3000 MHz	30	33	—	dB	
Inband VSWR	—	935 to 960 MHz	—	1.9	2.1	—	

F5CE Series (D2 type)

7. ISM900 (7 MHz Bandwidth)

Part number: FAR-F5CE-915M00-D238

(Ta = -30 to +85°C)

Parameter	Symbol	Conditions	Value			Unit	Remarks
			Min.	Typ.	Max.		
Insertion loss	IL	911.5 to 918.5 MHz	—	3.2	3.5	dB	
Inband ripple	—	911.5 to 918.5 MHz	—	0.3	1.0	dB	
Absolute attenuation	—	DC to 600 MHz	50	66	—	dB	
	—	600 to 840 MHz	40	35	—	dB	
	—	869 to 894 MHz	35	40	—	dB	
	—	970 to 1500 MHz	40	45	—	dB	
	—	1500 to 3000 MHz	25	28	—	dB	
Inband VSWR	—	911.5 to 918.5 MHz	—	1.8	2.0	—	

F5CE Series (D2 type)

■ TYPICAL CHARACTERISTICS (STANDARD VERSION)

1. PDC800 (Tx)

Part number: FAR-F5CE-950M00-D230

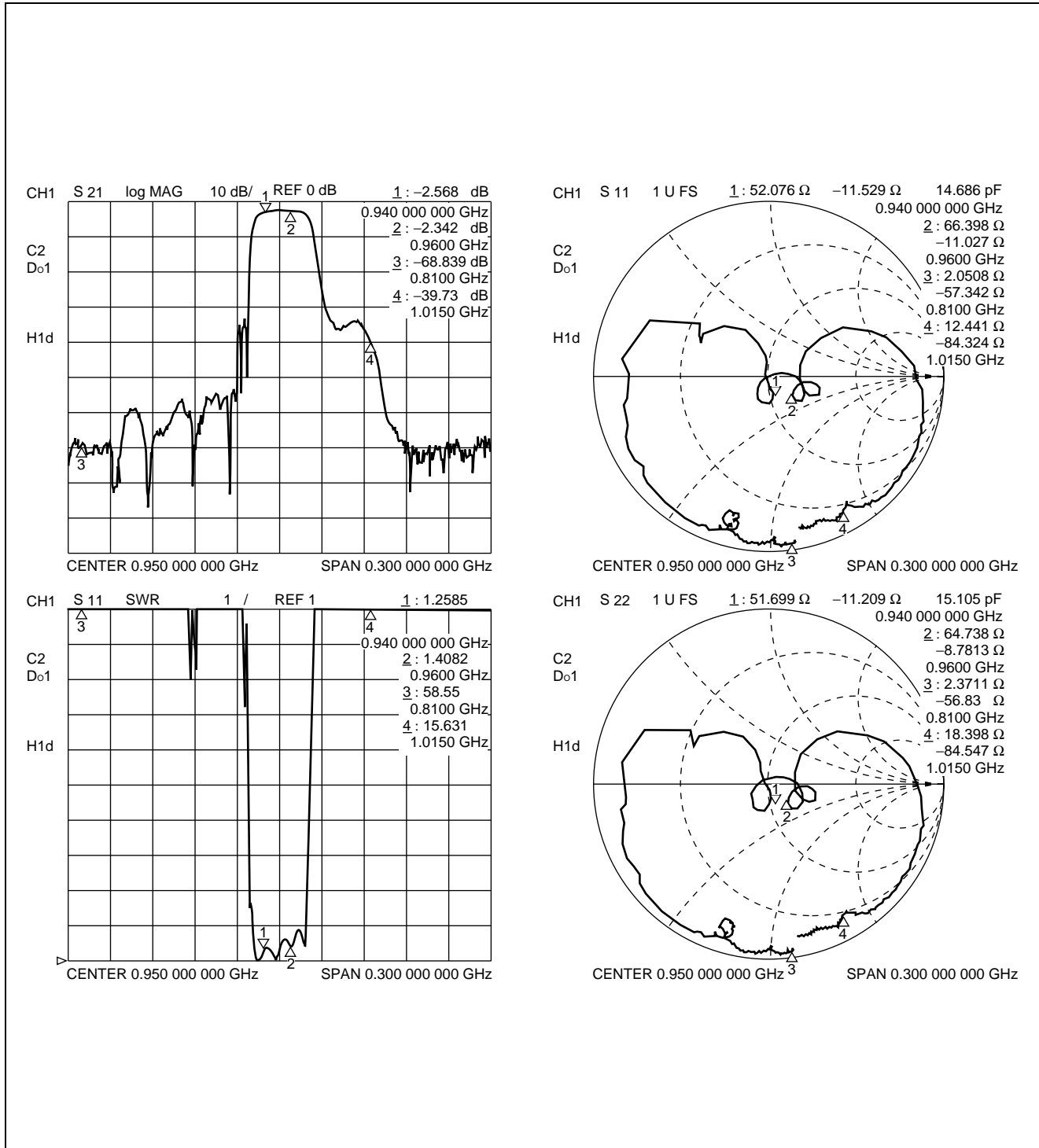

F5CE Series (D2 type)

2. PDC800 (Rx)

Part number: FAR-F5CE-820M00-D231

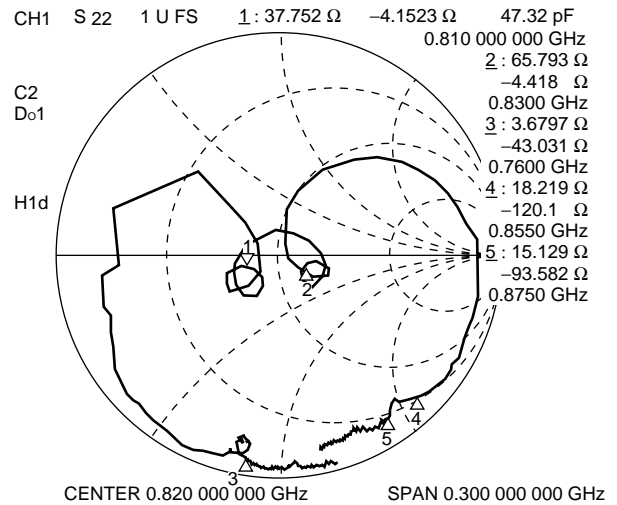
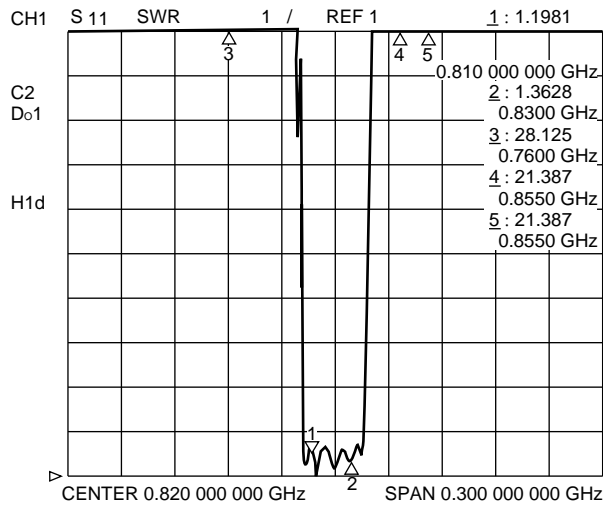
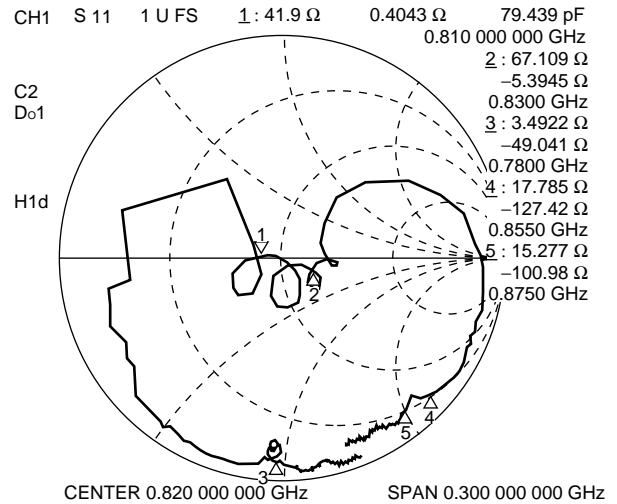
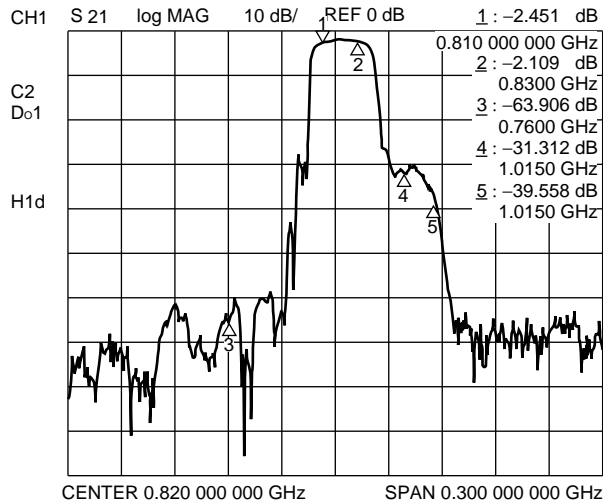

F5CE Series (D2 type)

3. AMPS/CDMA/TDMA (Tx)

Part number: FAR-F5CE-836M50-D232

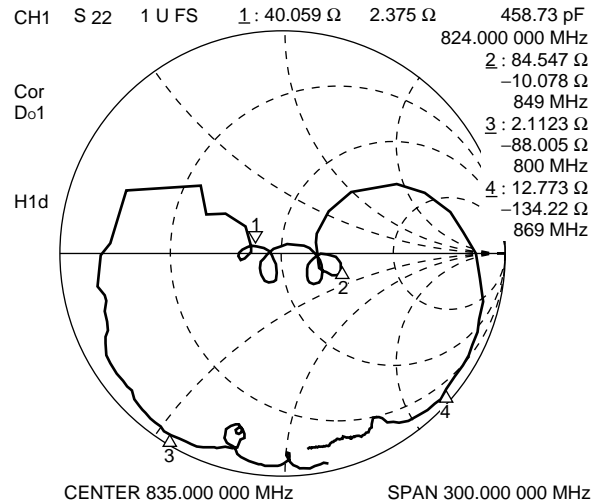
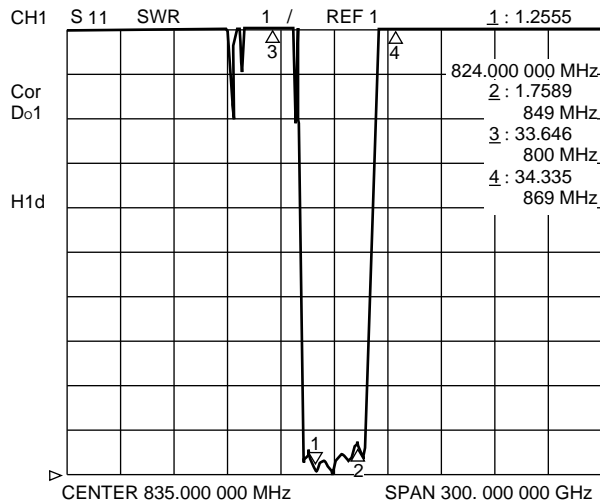
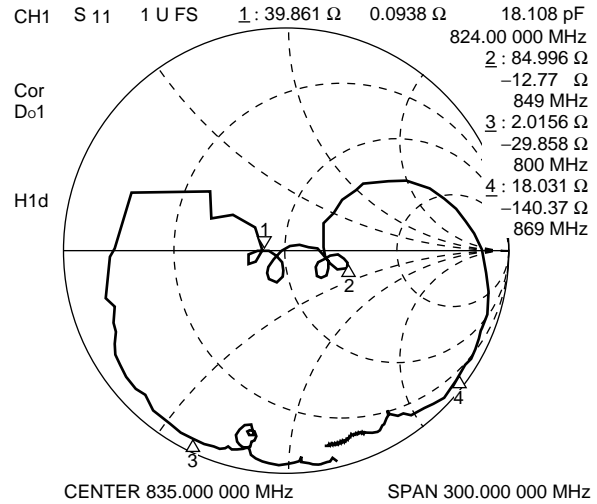
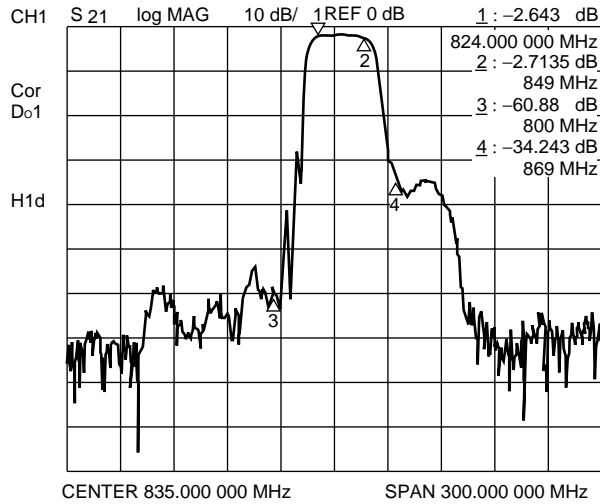

F5CE Series (D2 type)

4. AMPS/CDMA/TDMA (Rx)

Part number: FAR-F5CE-881M50-D233

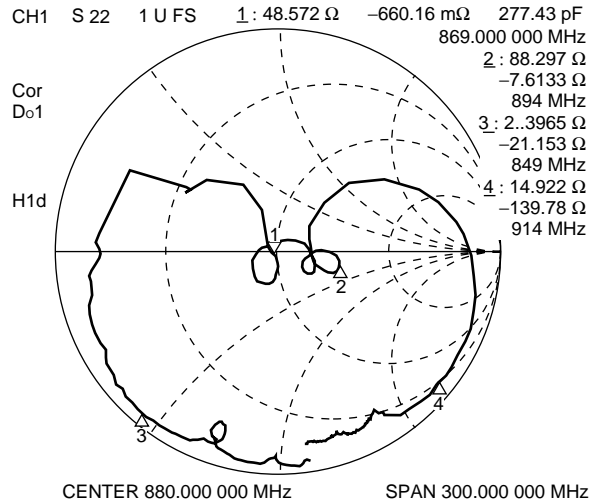
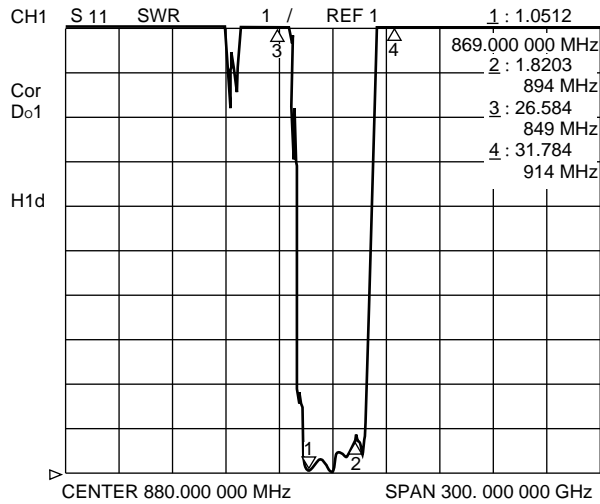
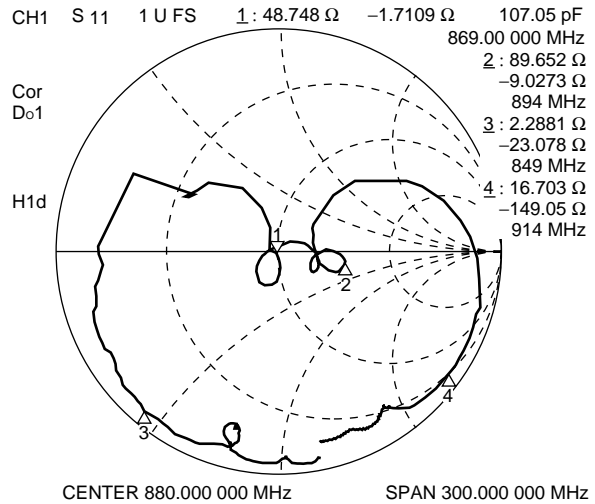
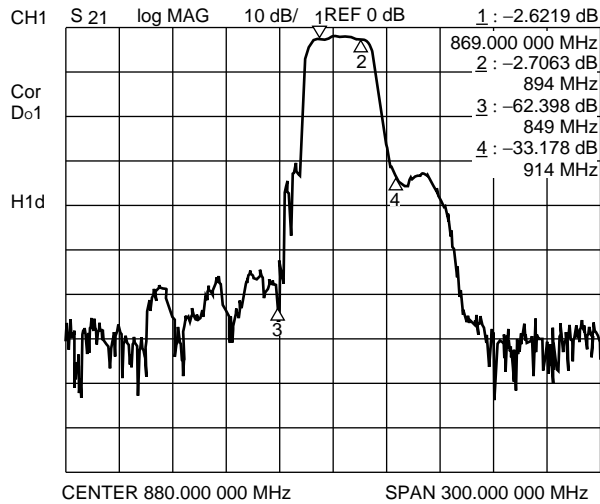

F5CE Series (D2 type)

5. GSM/NMT (Tx)

Part number: FAR-F5CE-902M50-D234

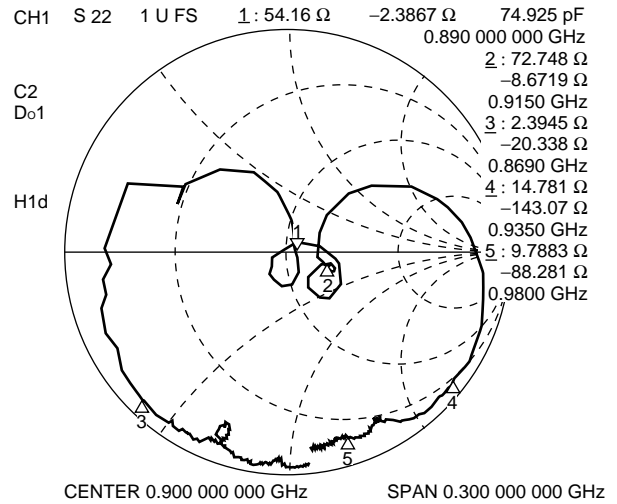
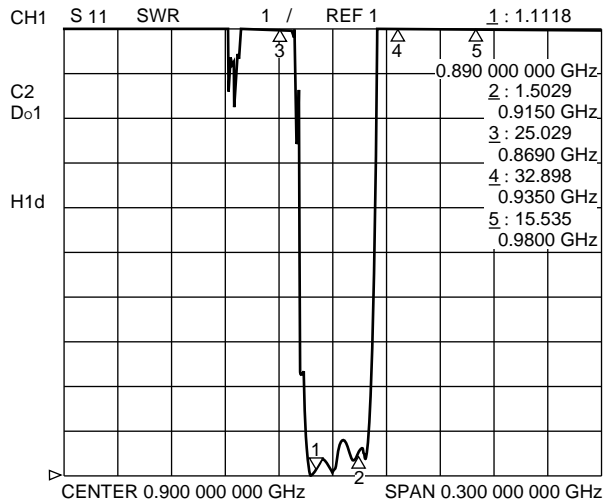
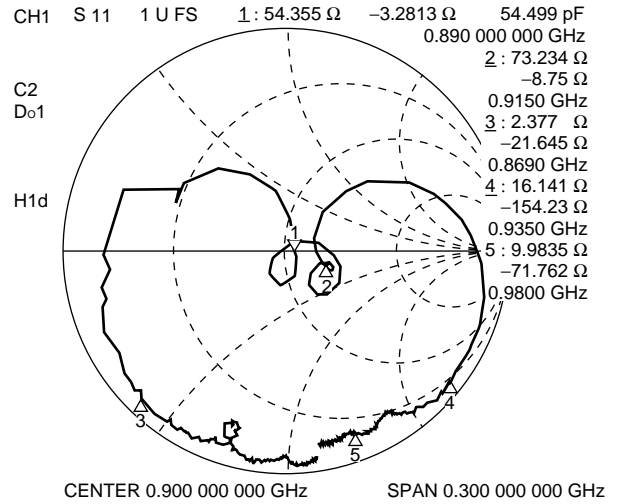
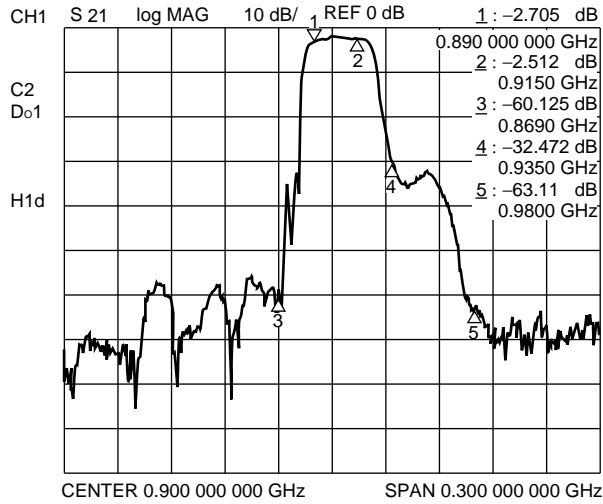

F5CE Series (D2 type)

6. GSM/NMT (Rx)

Part number: FAR-F5CE-947M50-D235

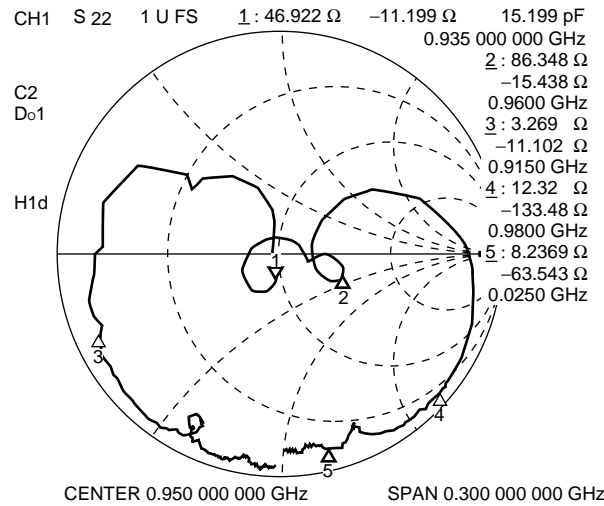
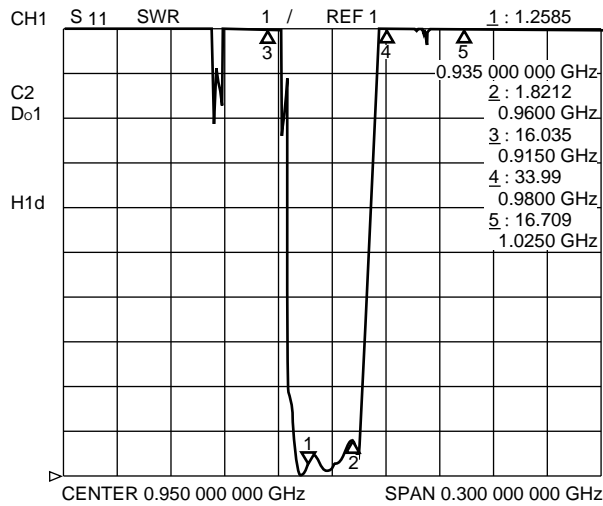
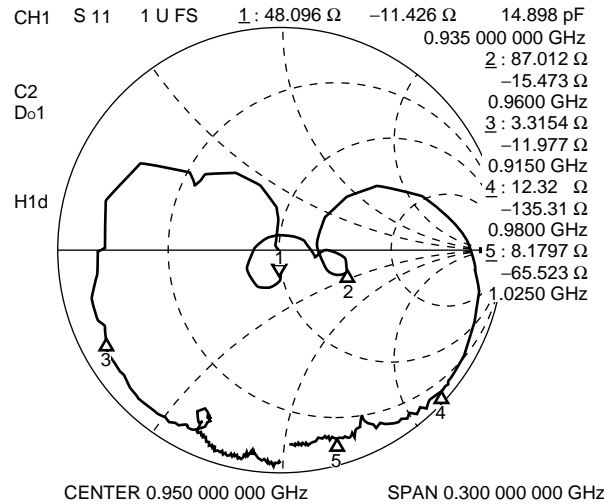
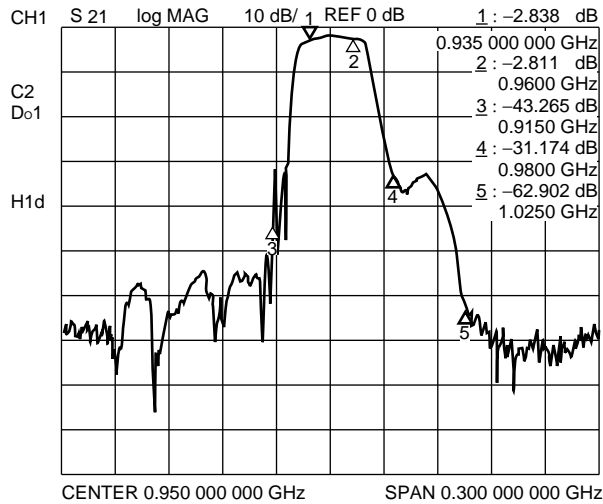

F5CE Series (D2 type)

7. ISM900 (7 MHz Bandwidth)

Part number: FAR-F5CE-915M00-D238

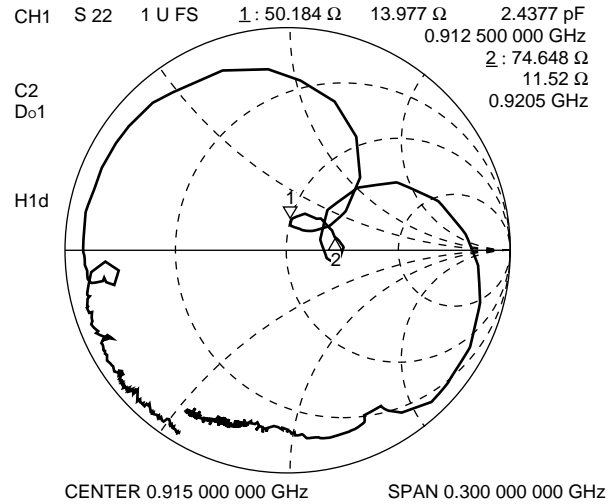
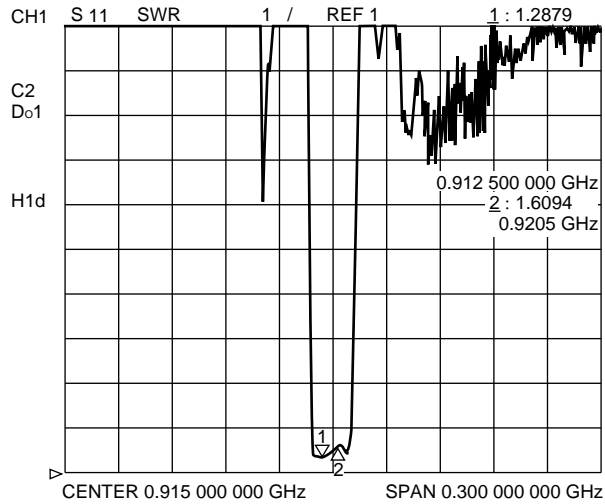
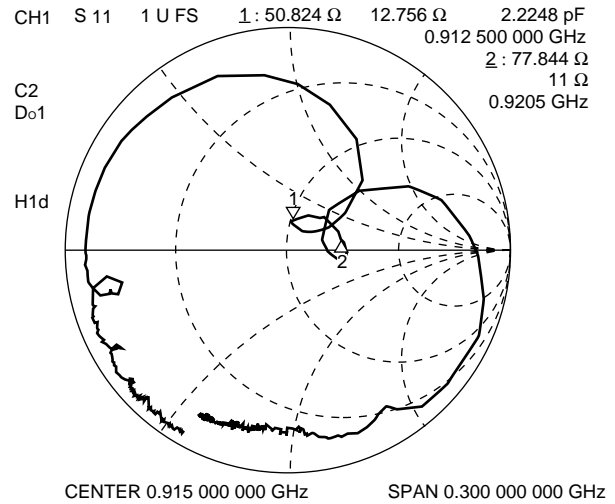
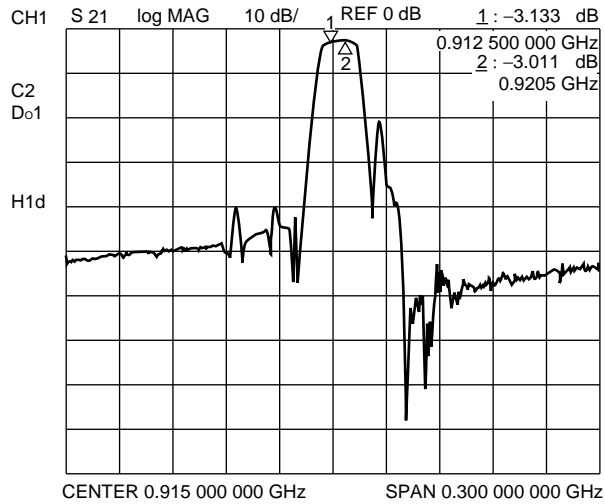

F5CE Series (D2 type)

■ PACKAGE DIMENSION

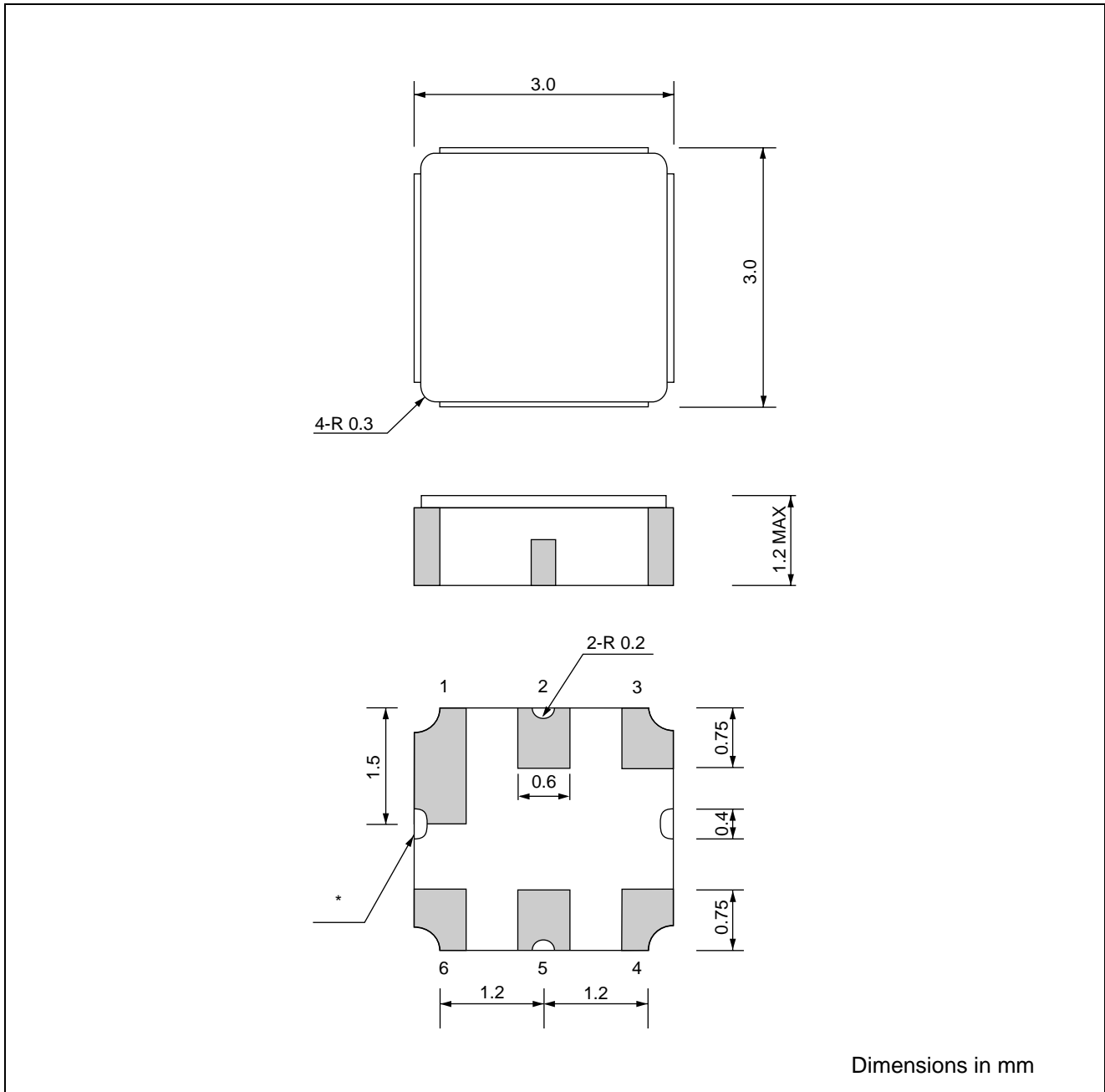

* : Two types of package are available.
One of them may be supplied without these cut outs.

F5CE Series (D2 type)

■ PACKING: Reel type

1. Reel Dimensions

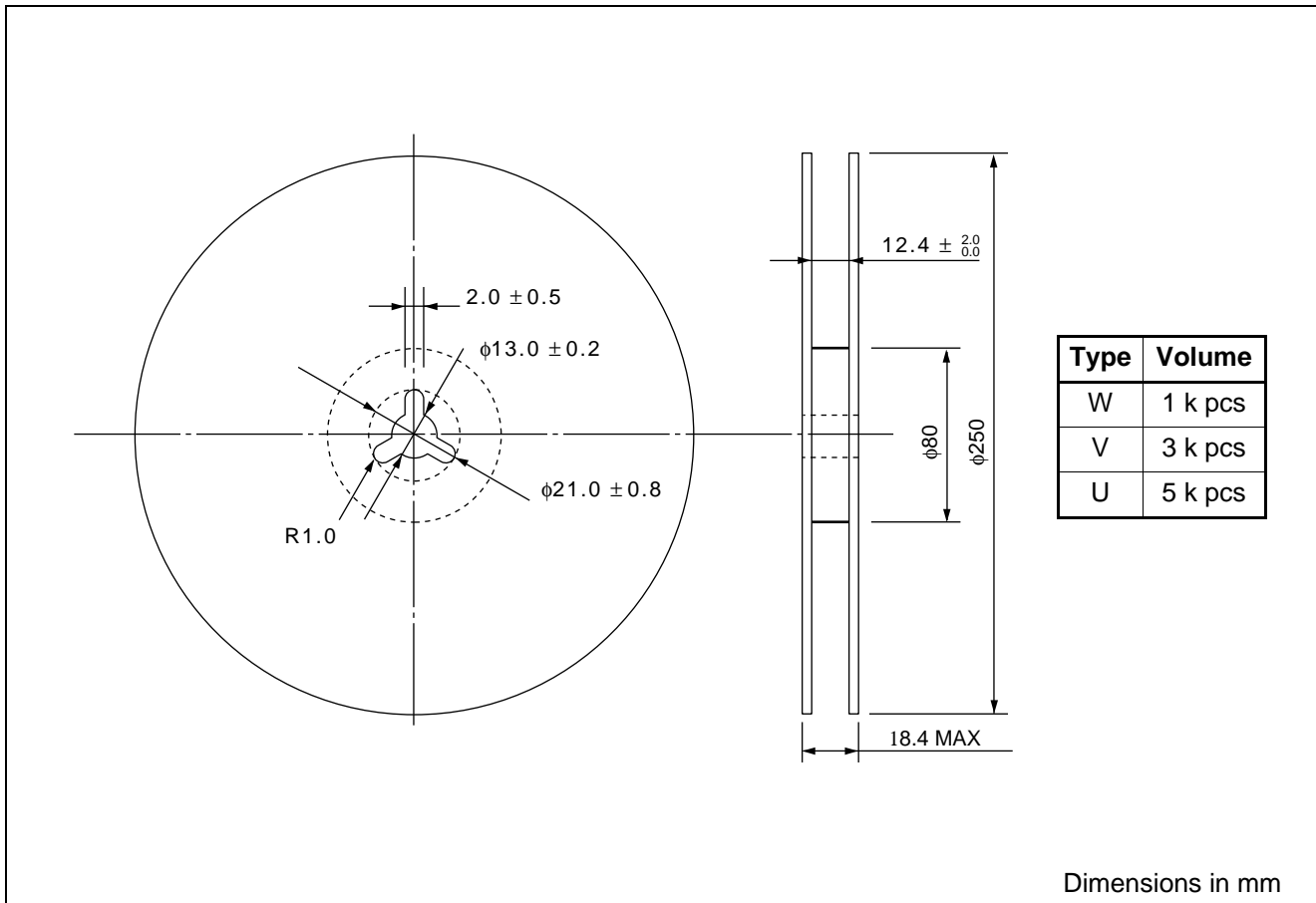

2. Packing Style

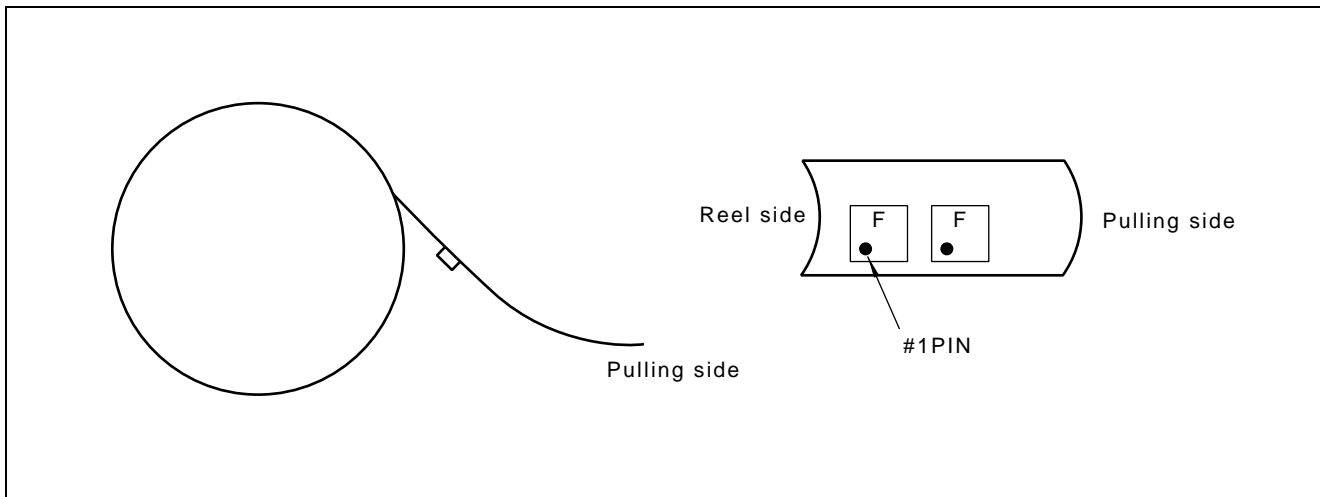

F5CE Series (D2 type)

3. Tape Dimensions

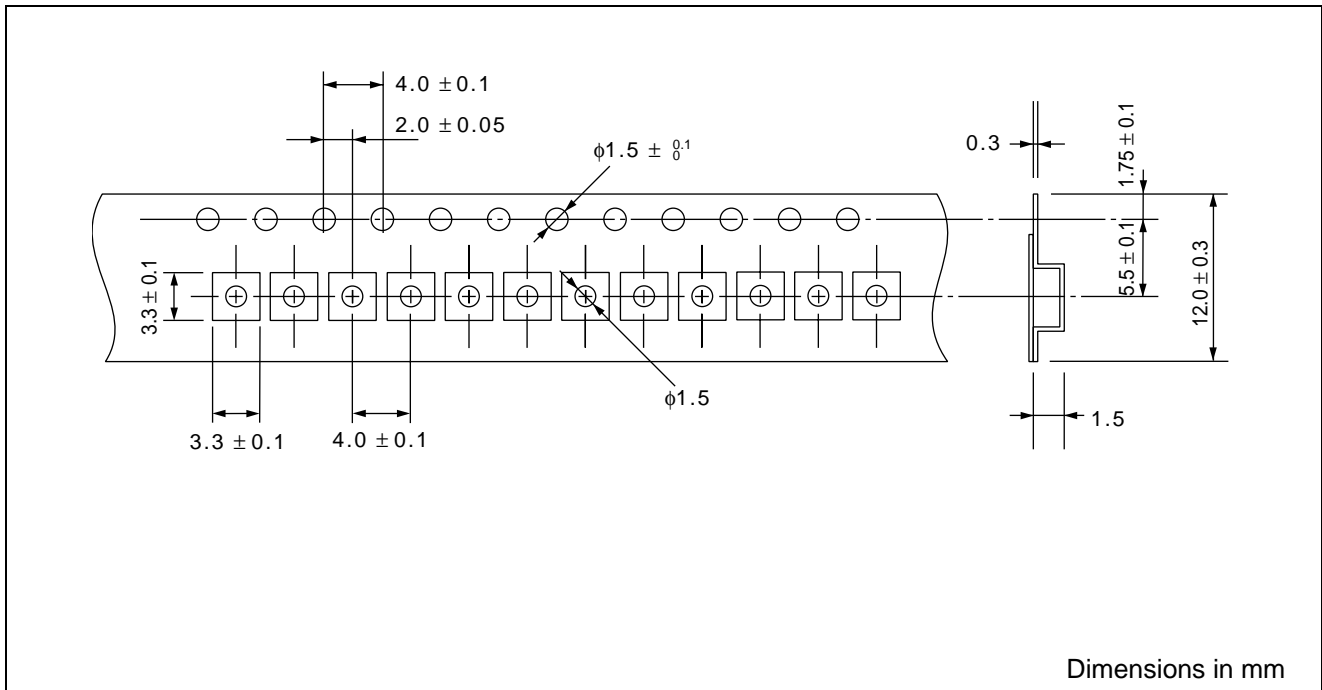

FUJITSU LIMITED

For further information please contact:

Japan

FUJITSU LIMITED
Corporate Global Business Support Division
Electronic Devices
KAWASAKI PLANT, 4-1-1, Kamikodanaka
Nakahara-ku, Kawasaki-shi
Kanagawa 211-8588, Japan
Tel: (044) 754-3763
Fax: (044) 754-3329

<http://www.fujitsu.co.jp/>

North and South America

FUJITSU MICROELECTRONICS, INC.
Semiconductor Division
3545 North First Street
San Jose, CA 95134-1804, USA
Tel: (408) 922-9000
Fax: (408) 922-9179

Customer Response Center
Mon. - Fri.: 7 am - 5 pm (PST)
Tel: (800) 866-8608
Fax: (408) 922-9179

<http://www.fujitsumicro.com/>

Europe

FUJITSU MIKROELEKTRONIK GmbH
Am Siebenstein 6-10
D-63303 Dreieich-Buchsschlag
Germany
Tel: (06103) 690-0
Fax: (06103) 690-122

<http://www.fujitsu-edc.com/>

Asia Pacific

FUJITSU MICROELECTRONICS ASIA PTE LTD
#05-08, 151 Lorong Chuan
New Tech Park
Singapore 556741
Tel: (65) 281-0770
Fax: (65) 281-0220

<http://www.fmap.com.sg/>

F9806

© FUJITSU LIMITED Printed in Japan

All Rights Reserved.

The contents of this document are subject to change without notice. Customers are advised to consult with FUJITSU sales representatives before ordering.

The information and circuit diagrams in this document presented as examples of semiconductor device applications, and are not intended to be incorporated in devices for actual use. Also, FUJITSU is unable to assume responsibility for infringement of any patent rights or other rights of third parties arising from the use of this information or circuit diagrams.

FUJITSU semiconductor devices are intended for use in standard applications (computers, office automation and other office equipment, industrial, communications, and measurement equipment, personal or household devices, etc.).

CAUTION:

Customers considering the use of our products in special applications where failure or abnormal operation may directly affect human lives or cause physical injury or property damage, or where extremely high levels of reliability are demanded (such as aerospace systems, atomic energy controls, sea floor repeaters, vehicle operating controls, medical devices for life support, etc.) are requested to consult with FUJITSU sales representatives before such use. The company will not be responsible for damages arising from such use without prior approval.

Any semiconductor devices have inherently a certain rate of failure. You must protect against injury, damage or loss from such failures by incorporating safety design measures into your facility and equipment such as redundancy, fire protection, and prevention of over-current levels and other abnormal operating conditions.

If any products described in this document represent goods or technologies subject to certain restrictions on export under the Foreign Exchange and Foreign Trade Control Law of Japan, the prior authorization by Japanese government should be required for export of those products from Japan.