

GENERAL DESCRIPTION

The EV1531DQ-002A Evaluation Board is designed to demonstrate the capabilities of MPS' MP1531 triple output step-up converter with charge-pumps.

The MP1531 includes a 250KHz fixed-frequency step-up converter and a positive and negative linear regulator. The linear regulators are powered via charge-pumps driven by the step-up converter switch node.

A single on/off control enables all 3 outputs. The outputs are internally sequenced at power-on for ease of use. An internal soft-start prevents overloading the input source at startup. Cycle-by-cycle current limit reduces component stress.

ELECTRICAL SPECIFICATION

Parameter	Symbol	Value	Units
Input Voltage	V_{IN}	2.7-5.5	V
Main Output Voltage	V_{MAIN}	5	V
Main Output Current	I_{MAIN}	100	mA
(+) Charge Pump Voltage	V_{GH}	15	V
(+) Charge Pump Current	I_{GH}	5	mA
(-) Charge Pump Voltage	V_{GL}	-10	V
(-) Charge Pump Current	I_{GL}	5	mA

FEATURES

- 2.7V to 5.5V Operating Input Range
- 500mA Switch Current Limit
- 3 Outputs in Single Package
 - Step-Up Converter up to 22V
 - Positive 10mA Linear Regulator
 - Negative 10mA Linear Regulator
- 250mΩ Internal Power MOSFET Switch
- Up to 95% Efficiency
- 1μA Shutdown Mode
- Fixed 250KHz Frequency
- Positive Regulator up to 38V
- Negative Regulator down to -20V
- Internal Power-On Sequencing
- Adjustable Soft-Start/Fault Timer
- Thermal Shutdown
- Cycle-by-Cycle Over Current Protection
- Under Voltage Lockout
- Ready Flag

APPLICATIONS

- TFT LCD Displays
- Portable DVD Players
- Tablet PCs
- Car Navigation Displays

MPS, "MPS", "Monolithic Power Systems", and "The Future of Analog IC Technology" are Registered Trademarks of Monolithic Power Systems, Inc.

EV1531DQ-002A EVALUATION BOARD



Dimensions (2.34"X x 2.25"Y x 0.50"Z)

Board Number	MPS IC Number
EV1531DQ-002A	MP1531

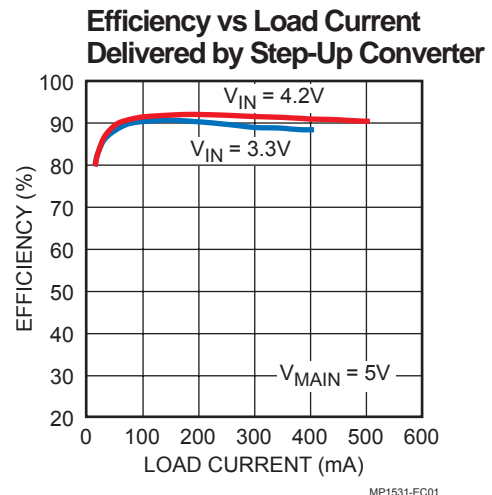

EV1531DQ-002A BILL OF MATERIALS *(continued)*

Qty	Ref	Description	Manufacturer P/N	Distributor P/N
1	C1	Ceramic Capacitor, 22 μ F, 10V, 1210, X5R	AVX:1210ZD226KAT2A	Digikey: 478-1632-1-ND
2	C8,C10	Ceramic Capacitor, 1 μ F, 25V, 1206, X7R	AVX:12063C105KAT2A	Digikey: 478-1567-1-ND
2	C2, C5	Ceramic Capacitor, 10nF, 50V, 0805, X7R	AVX:0805C103KAT2A	Digikey: 478-1383-1-ND
2	C6,C7	Ceramic Capacitor, 0.1 μ F, 50V, 0805, X7R	AVX:08055C104KAT2A	Digikey: 478-1395-1-ND
2	C9,C11	Ceramic Capacitor, 56pF, 50V, 0805, NPO	AVX:08055A560JAT2A	Digikey: 478-1313-1-ND
1	L1	Inductor, 33 μ H, 740mA	Coicraft:LP06013--333KX	
1	U1	MP1531DQ, QFN16	MPS: MP1531DQ	
2	R1,R11	Resistor, 100k Ω , 0805, 5%	Panasonic: ERJ-6GEYJ104V	Digikey: P100KACT-ND
1	R4	Resistor, 5.6k Ω , 0805, 5%	Panasonic: ERJ-6ENF562V	Digikey: P5.6KCCT-ND
1	R2	Resistor, 30.1k Ω , 0805, 1%	Panasonic: ERJ-6GEYJ303V	Digikey: P30KACT-ND
3	R3,R5,R8	Resistor, 10k Ω , 0805, 1%	Panasonic: ERJ-6GEYJ103V	Digikey: P10KACT-ND
1	R9	Resistor, 110k Ω , 0805, 1%	Panasonic: ERJ-6GEY114V	Digikey: P110KACT-ND
2	R6,R10	Resistor, 10 Ω , 0805, 5%	Panasonic: ERJ-6GEYJ100V	Digikey: P10ACT-ND
1	R7	Resistor, 80.6k Ω , 0805, 1%	Panasonic: ERJ-6ENF8062V	Digikey: P80.6KCCT-ND
1	JP1	Conn Jumper	Sullins: STC02SYAN	Digikey: S9000-ND

PRINTED CIRCUIT BOARD LAYOUT

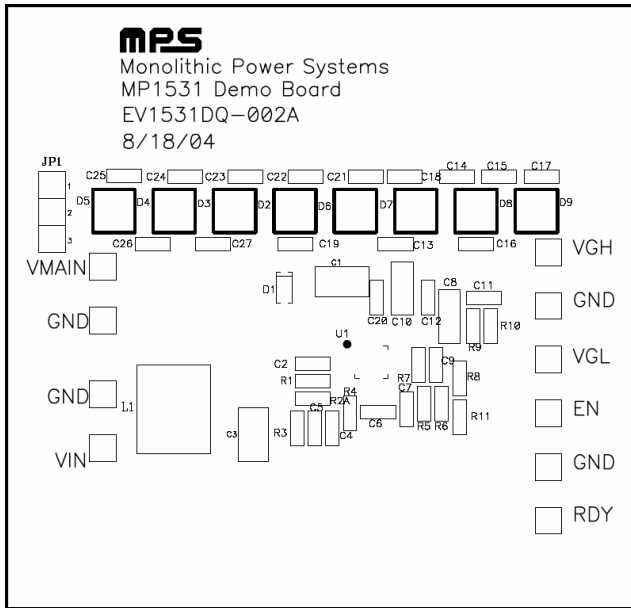

Figure 1—Top Silk Layer

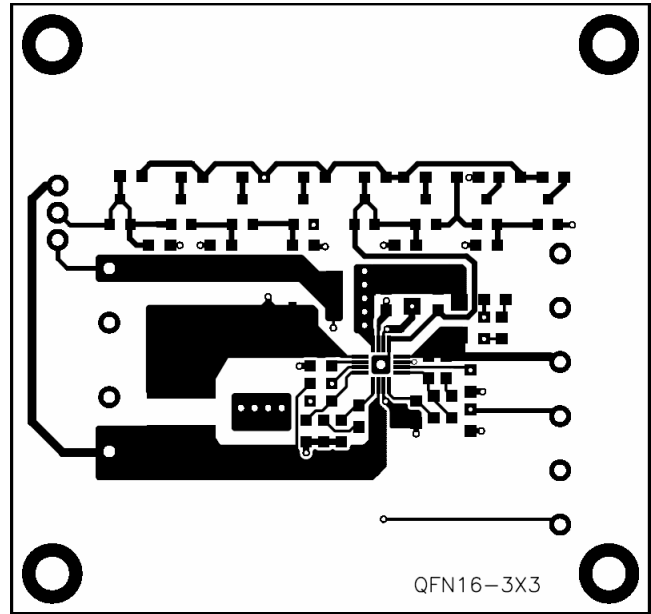

Figure 2—Top Layer

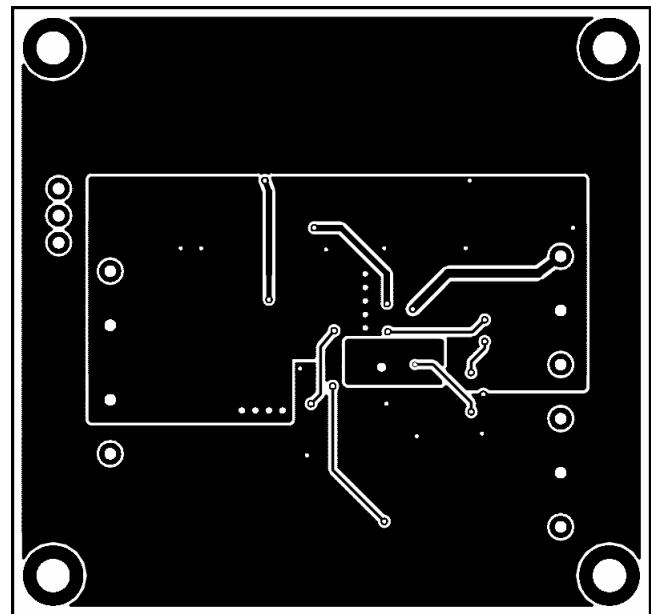
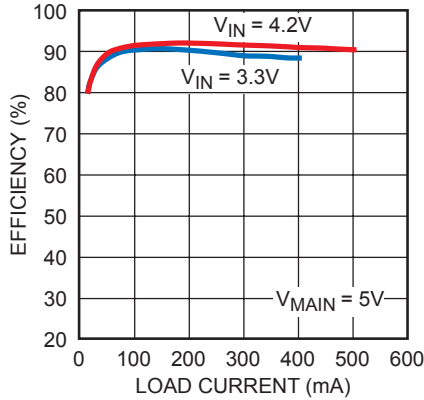

Figure 3—Bottom Layer

TEST RESULTS

Efficiency vs Load Current Delivered by Step-Up Converter



MP1531-TPC01

Load Transient

$V_{IN} = 3.3V, V_{MAIN} = 5V, 5mA-50mA STEP$
 $V_{GH} = 15V, I_{GH} = 5mA, V_{GL} = -10V, I_{GL} = 5mA$

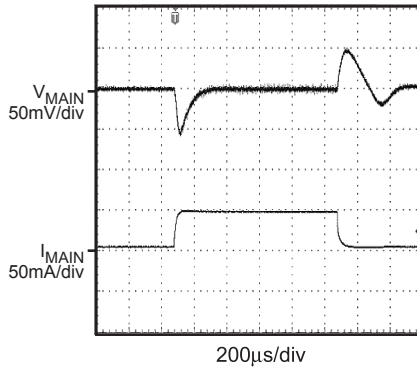

MP1531_WF01

Power-Up Sequencing

$V_{IN} = 3.3V, V_{MAIN} = 5V, I_{MAIN} = 100mA,$
 $V_{GH} = 15V, I_{GH} = 5mA, V_{GL} = -10V, I_{GL} = 5mA,$
 $C_{CT} = 10nF$

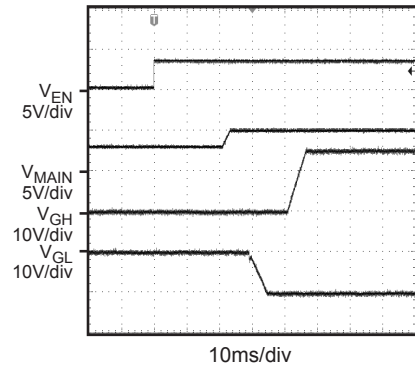

MP1531_WF02

QUICK START GUIDE

The three output voltages of this board are set to +5V, +15V, and -10V. The board layout accommodates most commonly used inductors and output capacitors.

1. Make sure Jumper JP1 is connected between 2 and 3.
2. Attach positive end of loads to VMAIN, VGH, and VGL pins respectively. Attach negative end of loads to GND pins.
3. Attach input voltage $2.7V \leq V_{IN} \leq 5.5V$ and input ground to VIN and GND pins respectively.
4. During startup \overline{RDY} will be left HIGH. Once the turn-on sequence is complete, this pin will be pulled low if all regulators exceed 80% of their specified voltages. After all regulators are turned on, a fault in any regulator will cause \overline{RDY} to go LOW after approximately 15µs. If the fault persists for more than approximately 6ms (for $C_{CT} = 10nF$), the entire chip will shut down.

NOTICE: MPS believes the information in this document to be accurate and reliable. However, it is subject to change without notice. Contact MPS for current specifications. MPS encourages users of its products to ensure that third party Intellectual Property rights are not infringed upon when integrating MPS products into any application. MPS cannot assume any legal responsibility for any said applications.