

Dual-Display White LED Driver with 3/2X Switched Capacitor Boost

DESCRIPTION

The EUP2796 is a charge-pump based white-LED driver that is ideal for mobile phone display backlighting. It can drive up to 6 LEDs in parallel with up to 20mA through each LED. Regulated internal current sources deliver excellent current and brightness matching in all LEDs. The LED-driver current sources are split into two independently controlled groups.

The primary group (4 LEDs) can be used to backlight the main phone display. The second group (2 LEDs) can be used to backlight a secondary display or to provide other lighting features (keypad LEDs, for example). Brightness of the two groups can be adjusted independently with pulse-width modulated (PWM) digital signals.

The EUP2796 works off an extended Li-Ion input voltage range (2.7V to 5.5V). Voltage boost is achieved with a high-efficiency 3/2-gain charge pump. The EUP2796 is available in a 16-pin TQFN package.

FEATURES

- Drives up to 6 LEDs with up to 20mA each
- LEDs controlled in 2 Distinct Groups, for Backlighting 2 Displays (main LCD and sub-LCD)
- Excellent Current and Brightness Matching
- High Efficiency 3/2X Charge Pump
- Extended Li-Ion Input: 2.7V to 5.5V
- PWM Brightness Control: 100Hz - 1kHz
- 3mm × 3mm TQFN-16 Package
- RoHS Compliant and 100% Lead(Pb)-Free

APPLICATIONS

- Mobile Phone Display Lighting
- Mobile Phone Keypad Lighting
- PDAs
- General LED Lighting

Typical Application Circuit

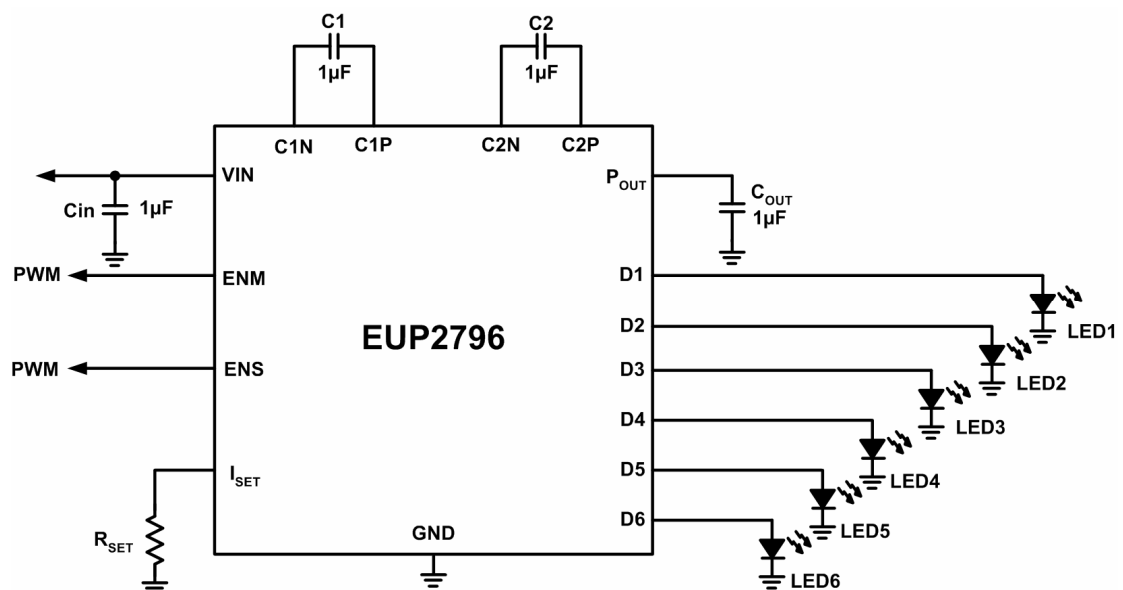

Figure 1.

Pin Configurations

Package Type	Pin Configurations
TQFN-16	

Pin Description

PIN	Pin	DESCRIPTION
C2P	1	Positive terminal of C2
P _{OUT}	2	Charge pump output
I _{SET}	3	Current sense input. Connect 1% resistor to ground to set constant current through LED
ENS	4	Enable for Group-B LEDs (D5~D6). Logic input High=Group-B LEDs ON. Low=GroupB LEDs OFF. Pulsing this pin with a PWM signal (100Hz-1kHz) can be used to dim LEDs.
ENM	5	Enable for Group-A LEDs (D1~D4). Logic input High=Group-A LEDs ON. Low=GroupA LEDs OFF. Pulsing this pin with a PWM signal (100Hz-1kHz) can be used to dim LEDs.
LED1-6	11,10,9,8,7,6	Current source outputs. Connect directly to LED
GND	12	Power supply ground input
C1N	13	Negative terminal of C1
VIN	14	Power supply voltage input
C2N	15	Negative terminal of C2
C1P	16	Positive terminal of C1

Ordering Information

Order Number	Package Type	Marking	Operating Temperature range
EUP2796JIR1	TQFN-16	XXXX 2796A	-40 °C to 85°C

EUP2796-

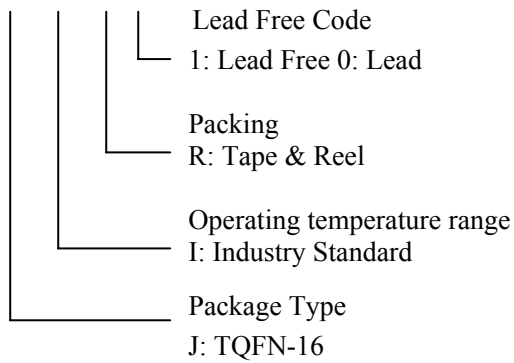

Block Diagram

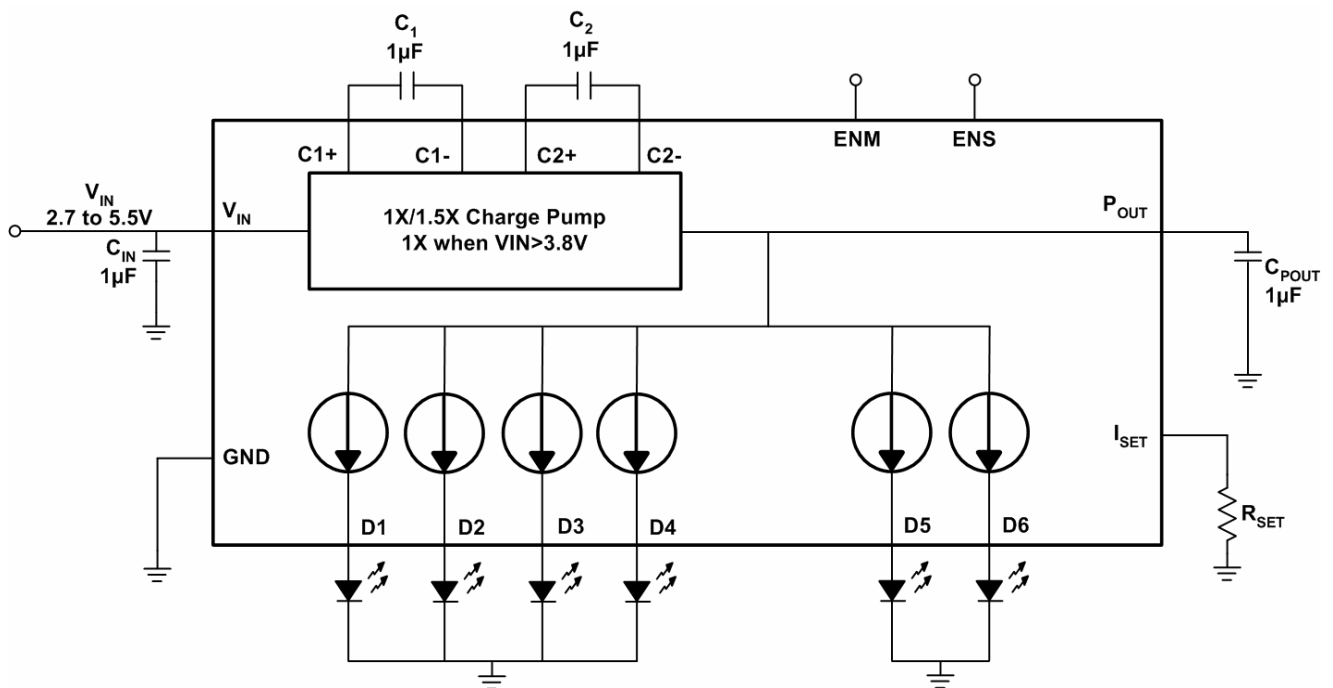

Figure 2.

Absolute Maximum Ratings

- V_{IN} ----- -0.3V to 6V max
- ENM,ENS, ----- -0.3V to ($V_{IN}+0.3V$) w/ 6V max
- Continuous Power Dissipation ----- Internally Limited
- TQFN-16L 3×3, θ_{JA} ----- 68°C/W
- Junction-to-Ambient Thermal resistance (θ_{JA}) ----- 100°C/W
- Junction Temperature (T_{J-MAX}) ----- 150°C
- Storage Temperature Range ----- -65°C to 150°C
- Lead Temp (Soldering, 10sec) ----- 265°C
- ESD Rating
Human Body Model ----- 2kV

Operating Conditions

- Input Voltage (V_{IN}) ----- 2.7V to 5.5V
- Ambient Temperature (T_A) ----- -40°C to 85°C

Electrical Characteristics

Limits in standard typeface and typical values apply for $T_J = 25^\circ\text{C}$. Limits in **boldface** type apply over the full operating junction temperature range ($-40^\circ\text{C} \leq T_J \leq 85^\circ\text{C}$). Unless otherwise specified: $V_{IN}=3.6\text{V}$; $V_{DX} = 3.4\text{V}$; $V(\text{EN}) = 2.0\text{V}$; Group A and Group B LEDs not ON simultaneously ($\text{ENM} = \text{ENS}=\text{V}_{IN}$); $R_{SET} = 7.5\text{k}$; C_{IN} , $C1,C2$, and $C_{POUT} = 1\mu\text{F}$.

Symbol	Parameter	Conditions	EUP2796			Unit
			Min	Typ	Max.	
I_{DX}	Output Current Regulation	$3.0\text{V} \leq V_{IN} \leq 4.2\text{V}$, and $V_{IN} = 5.5\text{V}$ $2.5\text{V} \leq V_{DX} \leq 3.4\text{V}$; $R_{SET}=7.5\text{k}$	14.3 (-8%)	15.5	16.8 (+8%)	mA(%)
		$3.0\text{V} \leq V_{IN} \leq 5.5\text{V}$, $2.5\text{V} \leq V_{DX} \leq 3.4\text{V}$; $R_{SET}=11.8\text{k}$		10		mA
		$3.0\text{V} \leq V_{IN} \leq 5.5\text{V}$, $2.5\text{V} \leq V_{DX} \leq 3.4\text{V}$; $R_{SET}=7.5\text{k}$		15		
		$2.7\text{V} \leq V_{IN} \leq 3.0\text{V}$, $2.5\text{V} \leq V_{DX} \leq 3.4\text{V}$; $R_{SET}=5.8\text{k}$		20		
$I_{D-MATCH}$	Current Matching Between Any Two Group A Outputs or Group B Outputs	$V_{IN}=3.0\text{V}$		± 0.3		%
I_Q	Quiescent Supply Current	$2.7\text{V} \leq V_{IN} \leq 4.2\text{V}$, No Load Current, ENM=ENS=OFF		4	7.5	mA
I_{SD}	Shutdown Supply Current	$2.7\text{V} \leq V_{IN} \leq 5.5\text{V}$, EN=OFF		0.1	1	μA
V_{SET}	I_{SET} Pin Voltage	$2.7\text{V} \leq V_{IN} \leq 5.5\text{V}$		1.18		V
I_{DX}/I_{SET}	Output Current to Current Set Ratio			100		
R_{OUT}	Charge Pump Output Resistance	$V_{IN}=3.0\text{V}$		3.5		Ω
V_{HR}	Current Source Headroom Voltage Requirement	$I_{DX}=95\% \times I_{DX}(\text{nom})$ $R_{SET}=7.5\text{k}$ ($I_{DX}(\text{nom}) \approx 15\text{mA}$)		300		mV
		$I_{DX}=95\% \times I_{DX}(\text{nom})$ $R_{SET}=11.8\text{k}$ ($I_{DX}(\text{nom}) \approx 10\text{mA}$)		200		
f_{SW}	Switching Frequency	$3.0\text{V} \leq V_{IN} \leq 4.2\text{V}$		500		kHz
t_{START}	Start-up Time	$I_{DX}=90\% I_{SET}$				
V_{IL}	SD Input Logic Low	$2.7\text{V} \leq V_{IN} \leq 5.5\text{V}$			0.5	V
V_{IH}	SD Input Logic High	$2.7\text{V} \leq V_{IN} \leq 5.5\text{V}$	1.1			V
I_{LEAK}	Input Leakage Current	$V_{ENX}=0\text{V}$		0.1		μA

Typical Operating Characteristics

LED Current vs VIN

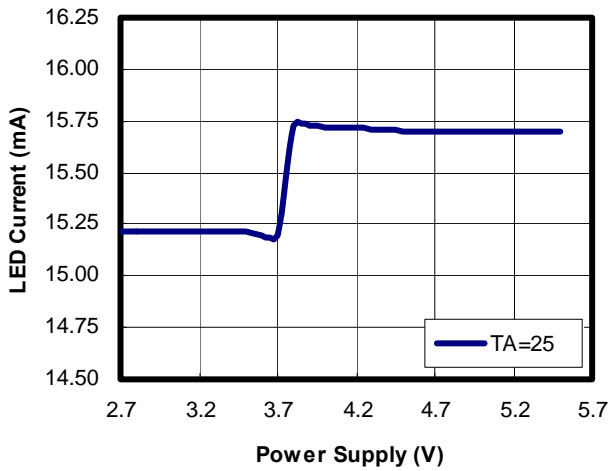

Vset vs Power Supply

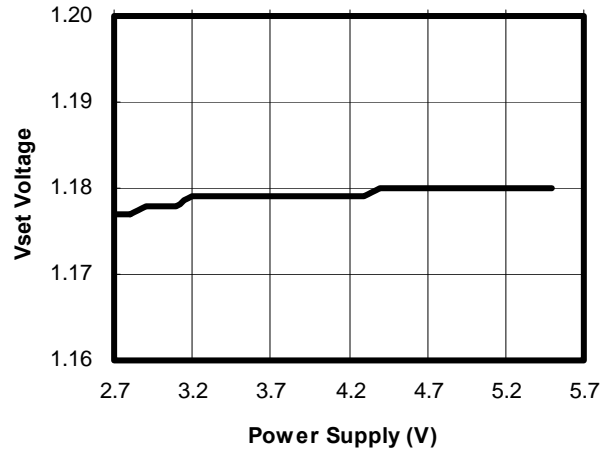

LED Current vs RSET

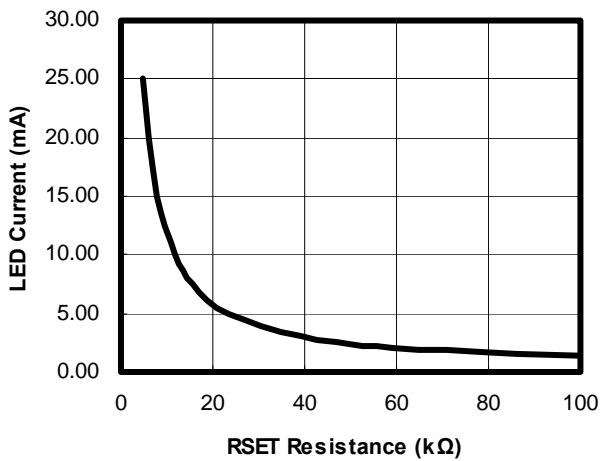

Head Room Voltage vs LED Current

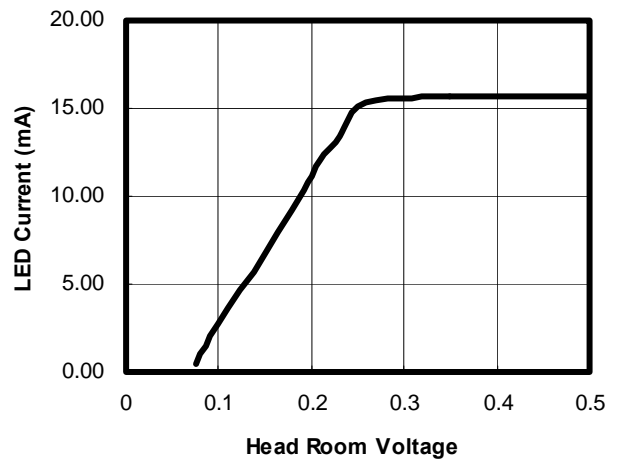

Efficient vs Supply Voltage
Driving Six WLEDs (Rset=7.5KΩ, VLED=3.6V)

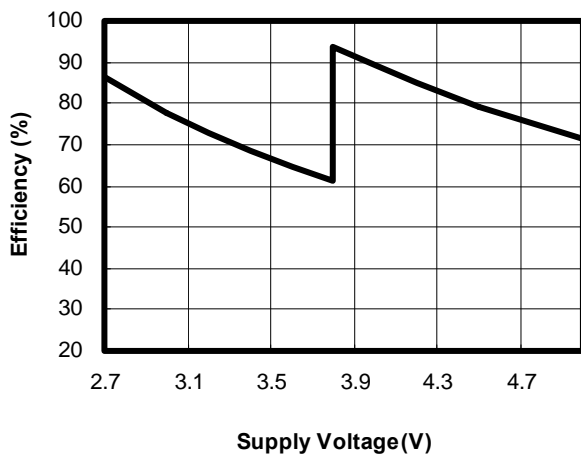

Input Current vs. Supply Voltage
Driving Six WLEDs (Rset=7.5KΩ, VLED=3.6V)

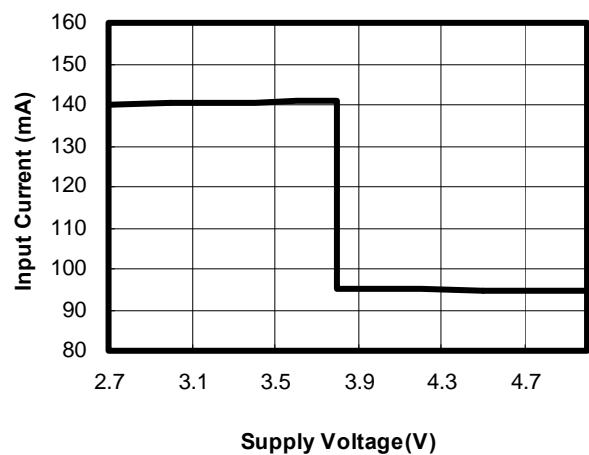

Input Current vs. Supply Voltage
(Rset=7.5KΩ, VLED=3.6V)

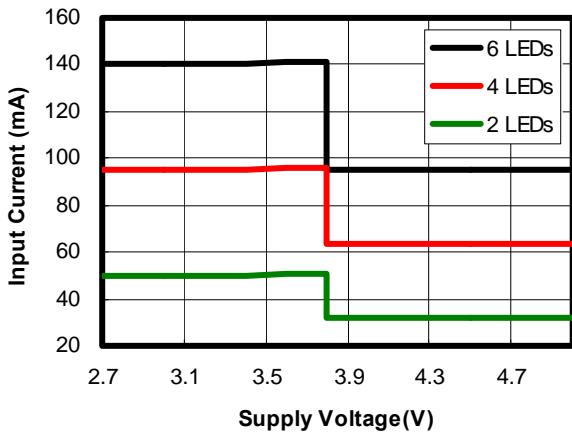

LED Current Matching vs. Supply Voltage
(Rset=7.5KΩ, VLED=3.6V)

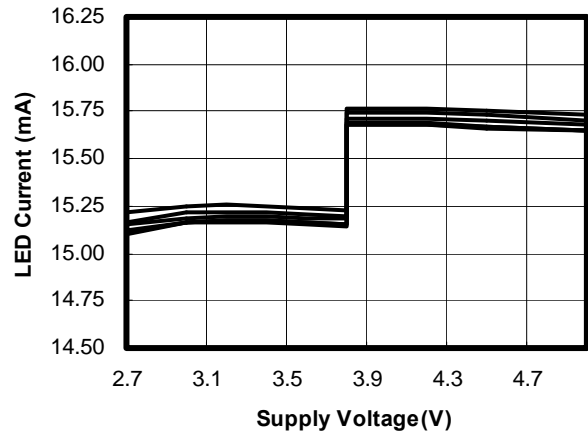

LED Dimming Response

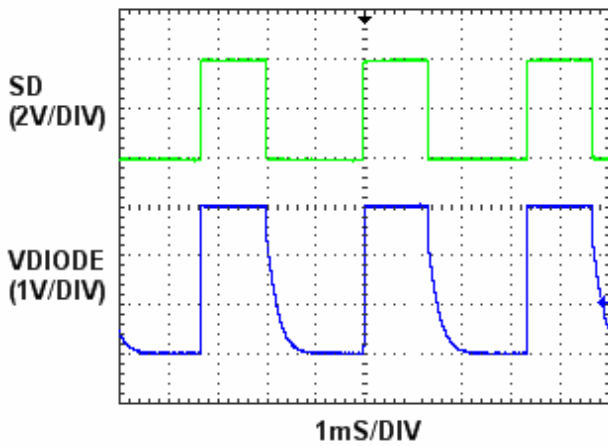

LED Dimming Response

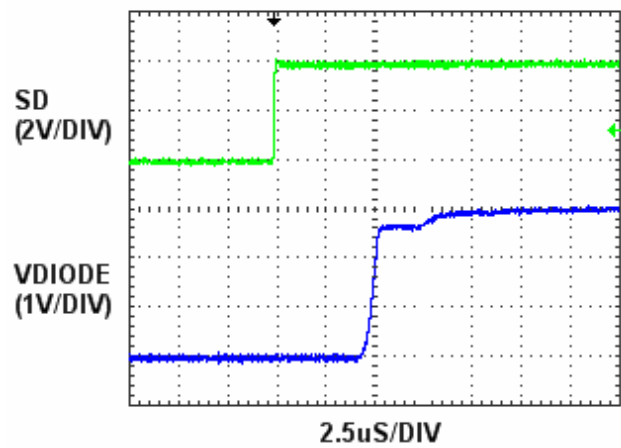

Operating Waveform (1X)

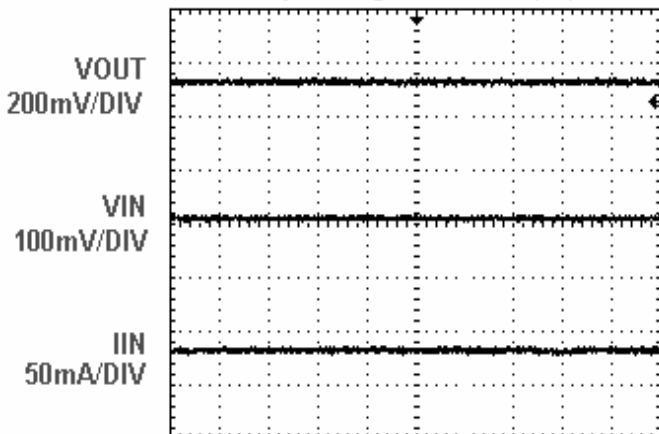

Operating Waveform (1.5X)

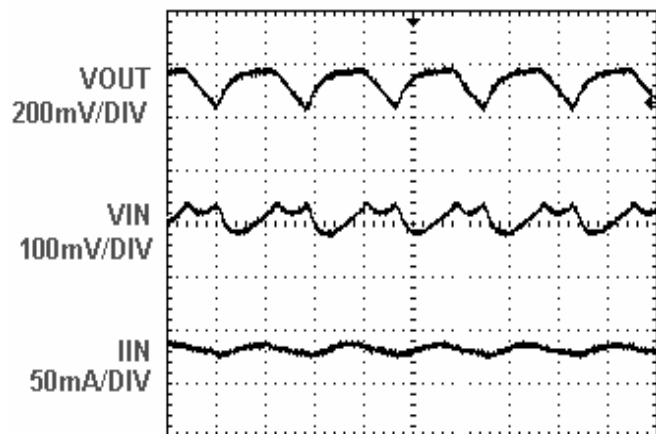

Application Information

Enable Pins: ENM, ENS

The EUP2796 has 2 enable pins-ENM and ENS, which control the main and sub LEDs. All two are active-high logic (HIGH = ON). When both of ENM or ENS voltage is low (<0.5V), the part is in shutdown mode. All internal circuitry is OFF and the part consumes almost no supply current when the EUP2796 is shutdown. When the voltage on either of ENM and ENS pin is high (>1.1V), the part is active. The charge pump is ON, and turn on the output currents to drive the LEDs. ENM activates/deactivates the four group-A outputs (D1-D4). ENS activates/deactivates the two group-B outputs (D5-D6).

There is no pull down resistors that are connected internally between each of the enable pins to ground.

Setting LED Currents

The output currents of the EUP2796 can be set to a desired value simply by connecting an appropriately sized resistor (R_{SET}) between the I_{SET} pin of the EUP2796 and GND. The output currents (LED currents) are proportional to the current that flows out of the I_{SET} pin. The output currents are a factor of 100 greater than the I_{SET} current. The feedback loop of an internal amplifier sets the voltage of the I_{SET} pin to 1.18V(typ.). Placing a resistor between I_{SET} and GND programs the I_{SET} current, and thus the LED currents. The statements above are simplified in the equations below:

$$I_{DXX} = 100 \times (V_{SET} \times R_{SET})$$

$$R_{SET} = 100 \times (1.18V \times I_{DXX})$$

Maximum Output Current, Maximum LED Voltage, Minimum Input Voltage

The EUP2796 can drive 6 LEDs at 15mA each from an input voltage as low as 3.0V, so long as the LEDs have a forward voltage of 3.6V or less (room temperature).

The statement above is a simple example of the LED drive capabilities of the EUP2796. The statement contains the key application parameters that are required to validate an LED- drive design using the EUP2796: LED current (I_{LED}), number of active LEDs (N), LED forward voltage (V_{LED}), and minimum input voltage (V_{IN-MIN}).

The equation below can be used to estimate the total output current capability of the EUP2796:

$$I_{LED_MAX} = \frac{1.5 * V_{IN} - V_{LED}}{N * R_{OUT} + K_{HR}}, \text{(eq.1)}$$

$$I_{LED_MAX} = \frac{1.5 * V_{IN} - V_{LED}}{N * 4\Omega + 12mV / mA}$$

R_{OUT} – Output resistance. This parameter models the internal losses of the charge pump that result in voltage droop at the pump output P_{OUT} . Since the magnitude of the voltage droop is proportional to the total output current of the charge pump, the loss parameter is modeled as a resistance. The output resistance of the EUP2796 is typically 4Ω ($V_{IN} = 3.0V$, $T_A = 25^\circ C$). In equation form:

$$V_{POUT} = 1.5 \times V_{IN} - N \times I_{LED} \times R_{OUT} \text{(eq.2)}$$

K_{HR} – Headroom constant. This parameter models the minimum voltage required to be present across the current sources for them to regulate properly. This minimum voltage is proportional to the programmed LED current, so the constant has units of mV/mA. The typical K_{HR} of the EUP2796 is 12mV/mA. In equation form:

$$(V_{POUT} - V_{LED}) > K_{HR} \times I_{LED} \text{(eq.3)}$$

The " $I_{LED-MAX}$ " equation (eq. 1) is obtained from combining the R_{OUT} equation (eq. 2) with the K_{HR} equation (eq. 3) and solving for I_{LED} . Maximum LED current is highly dependent on minimum input voltage and LED forward voltage. Output current capability can be increased by raising the minimum input voltage of the application, or by selecting an LED with a lower forward voltage. Excessive power dissipation may also limit output current capability of an application.

Soft-Start

The EUP2796 contains internal soft-start circuitry to limit input inrush currents when the part is enabled. Soft start is implemented internally with a controlled turn-on of the internal voltage reference. During soft start, the current through the LED outputs rise at the rate of the reference voltage ramp. Due to the soft-start circuitry, turn-on time of the EUP2796 is approximately 100 μ s (typ.).

Thermal Protection

Internal thermal protection circuitry disables the EUP2796 when the junction temperature exceeds 160°C (typ.). This feature protects the device from being damaged by high die temperatures that might otherwise result from excessive power dissipation. The device will recover and operate normally when the junction temperature falls below 140°C (typ.). It is important that the board layout provides good thermal conduction. This will help to keep the junction temperature within specified operating ratings.

Adjusting LED Brightness (PWM control)

Perceived LED brightness can be adjusted using a PWM control signal to turn the EUP2796 current sources ON and OFF at a rate faster than perceptible by the eye. When this is done, the total brightness perceived is proportional to the duty cycle (D) of the PWM signal (D = the percentage of time that the LED is on in every PWM cycle). A simple example: if the LEDs are driven at 15mA each with a PWM signal that has a 50% duty cycle, perceived LED brightness will be about half as bright as compared to when the LEDs are driven continuously with 15mA. A PWM signal thus provides brightness (dimming) control for the solution.

The minimum recommended PWM frequency is 100Hz. Frequencies below this may be visibly noticeable as flicker or blinking. The maximum recommended PWM frequency is 1kHz. Frequencies above this may cause interference with internal current driver circuitry.

The preferred method for applying a PWM signal to adjust brightness is to keep the master EN voltage ON continuously and to apply the PWM signal(s) to the current source enable pin(s): ENM and/or ENS. The benefit of this type of connection can be best understood with a contrary example. When a PWM signal is connected to the master enable (EN) pin, the charge pump repeatedly turns on and off. Every time the charge pump turns on, there is an inrush of current as capacitances, both internal and external, are recharged.

This inrush current results in a current and voltage spike at the input of the part. By only applying the PWM signal to ENM/ENS, the charge pump stays on continuously and much lower input noise results.

In cases where a PWM signal must be connected to the EN pin, measures can be taken to reduce the magnitude of the charge-pump turn-on voltage spikes. More input capacitance, series resistors and/or ferrite beads may provide benefits.

Capacitor Selection

The EUP2796 requires 4 external capacitors for proper operation. Surface-mount multi-layer ceramic capacitors are recommended. These capacitors are small, inexpensive and have very low equivalent series resistance (ESR < 20m typ.). Tantalum capacitors, OS-CON capacitors, and aluminum electrolytic capacitors are not recommended for use with the EUP2796 due to their high ESR, as compared to ceramic capacitors.

For most applications, ceramic capacitors with X7R or X5R temperature characteristic are preferred for use with the EUP2796. These capacitors have tight capacitance tolerance (as good as $\pm 10\%$) and hold their value over temperature (X7R: $\pm 15\%$ over -55°C to 125°C; X5R: $\pm 15\%$ over -55°C to 85°C).

Capacitors with Y5V or Z5U temperature characteristic are generally not recommended for use with the EUP2796. Capacitors with these temperature characteristics typically have wide capacitance tolerance (80%, -20%) and vary significantly over temperature (Y5V: 22%, -82% over -30°C to 85°C range; Z5U: 22%, -56% over 10°C to 85°C range). Under some conditions, a nominal 1 μ F Y5V or Z5U capacitor could have a capacitance of only 0.1 μ F. Such detrimental deviation is likely to cause Y5V and Z5U capacitors to fail to meet the minimum capacitance requirements of the EUP2796.

For LED driver applications, the input voltage ripple is more important than output ripple. Input ripple is controlled by input capacitor C_{IN}, increasing the value of input capacitance can further reduce the ripple. Practically, the input voltage ripple depends on the power supply's impedance. If a single input capacitor C_{IN} cannot satisfy the requirement of application, it is necessary to add a low-pass filter.

Packaging Information

TQFN-16

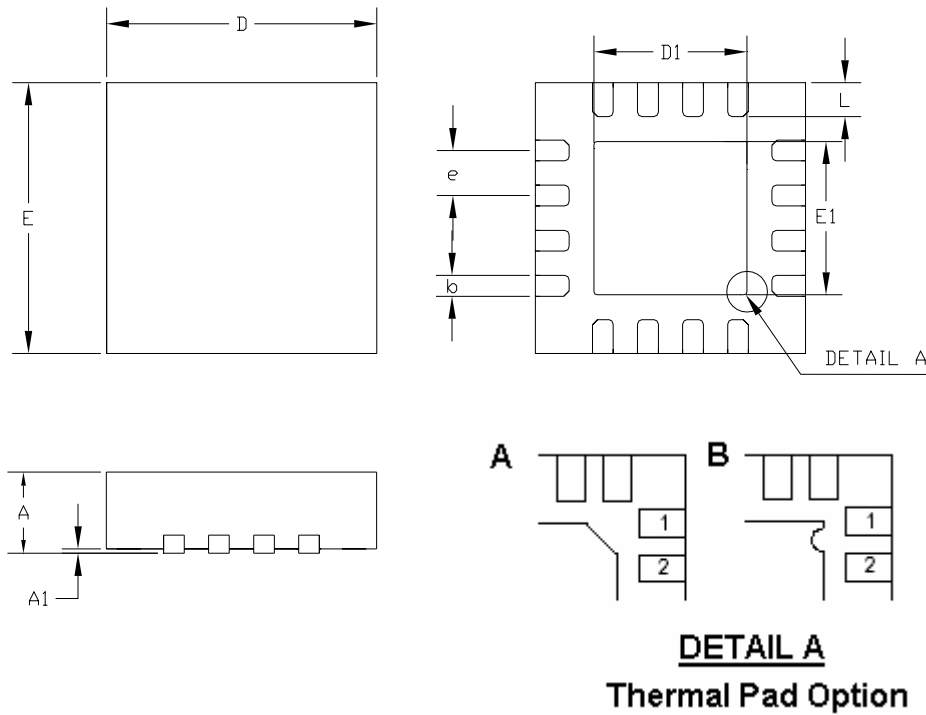

SYMBOLS	MILLIMETERS		INCHES	
	MIN.	MAX.	MIN.	MAX.
A	0.70	0.80	0.028	0.031
A1	0.00	0.05	0.000	0.002
b	0.18	0.30	0.007	0.012
E	2.90	3.10	0.114	0.122
D	2.90	3.10	0.114	0.122
D1	1.70		0.067	
E1	1.70		0.067	
e	0.50		0.020	
L	0.30	0.50	0.012	0.020