



RoHS Compliant



ET

Introduction

The **ET** series is Copal's standard size high capacity toggle switch. The **ET** series are available in various current rating, switching functions, and terminals. The housing is made of self-extinguishing phenol resin which has excellent heat resistance, arc resistance, and tracking resistance. The contacts are designed to eliminate chattering and bouncing to prevent insulation deterioration.

Part Numbering

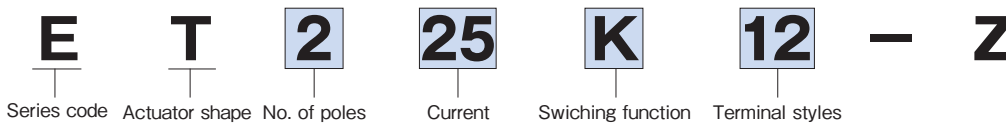

Fig.	No. of poles
1	1 pole
2	2 poles
3	3 poles
4	4 poles
6	6 poles

Fig.	AC125V		AC250V	
	3A	—	3A	—
03	3A	—	3A	—
05	5A	—	3A	—
06	6A	—	(2A)	—
10	10A	—	(7A)	—

Fig.	AC125V		AC250V	
	15A	10A	15A	10A
15	15A	10A	15A	10A
20	20A	12A	20A	12A
25	25A	15A	25A	15A
30	30A	(25A)	30A	(25A)

1 pole 3 poles	2 poles 4 poles 6 poles	Key way		
		ON	—	OFF
A	K	ON	—	OFF
B	L	ON	—	(OFF)
C	M	OFF	—	(ON)
D	N	ON	—	ON
E	P	ON	OFF	ON
F	R	ON	—	(ON)
G	S	(ON)	OFF	(ON)
H	T	ON	OFF	(ON)

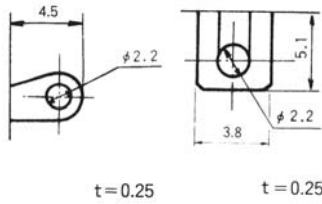

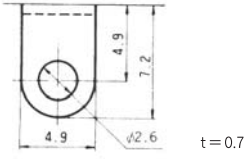

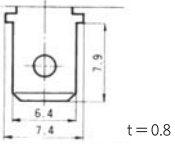

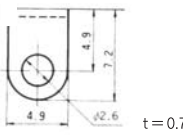



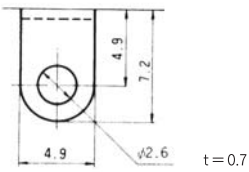

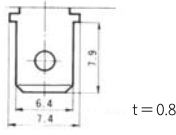

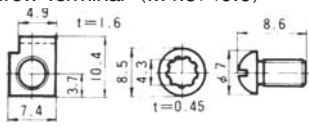

Fig.	Terminal style
None	TAB # 250
10	Screw Terminal
12	Solder Terminal
13	Plate Connect Solder Terminal
32	Solder Terminal









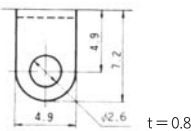

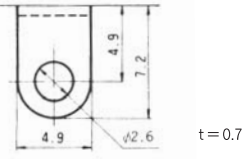

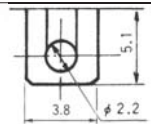
Terminal Style and Dimensions

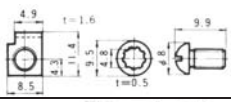
TAB # 250 (Style : -)	Screw Terminal (Style : 10)			Solder Terminal		
	M3.5 × 0.6	M4 × 0.7	M4.5 × 0.75	Solder Terminal (Style: 12 · 13)	Style: 12	Style: 32
					ET103□12 Type ET206□12 Type	ET103□ 32 Type

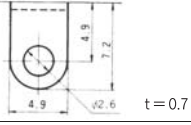
(ON) and (OFF) : Momentary. Please refer to P.636 for Common Specifications

ET Series Selection Table

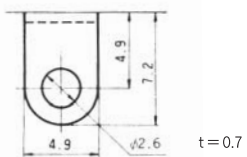
Part No.	Appearance	No. of poles	Rating	Switching function	Terminal style	Page
ET103		1	AC125V 3A	ON — OFF ON — ON (Cut two-wire)	Solder Terminal  t=0.25 t=0.25	419
						
ET105		1	AC125V 5A AC250V 3A	ON — OFF ON — ON ON — OFF — ON	Solder Terminal  t=0.7	419
ET205		2				421
ET110		1	AC125V 10A AC250V 7A	ON — OFF ON — ON ON — OFF — ON (ON) — OFF — (ON) ON — OFF — (ON)	TAB#250  t=0.8	420
ET210		2				AC125V 10A
ET115		1	AC125V 15A AC250V 10A	ON — OFF ON — (OFF) OFF — (ON) ON — ON ON — (ON) (ON) — OFF — (ON) ON — OFF — (ON)	Solder Terminal  t=0.7	420
ET215		2				422
ET315		3				424
ET415		4				Solder Terminal  t=0.7
ET415 Plate type			426			
ET120		1	AC125V 20A AC250V 12A	ON — OFF ON — ON ON — OFF — ON ON — (ON) (ON) — OFF — (ON) ON — OFF — (ON)	TAB#250  t=0.8	420
ET125		1	AC125V 25A AC250V 15A	ON — OFF ON — ON ON — OFF — ON	Screw Terminal (M4.5×0.6)  t=0.45	421
ET225		2				Solder Terminal  t=0.8

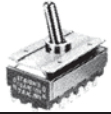
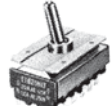
Part No.	Appearance	No. of poles	Rating	Switching function	Terminal style	Page
ET325		3	AC125V 25A AC250V 15A	ON — OFF	Solder Terminal 	424
ET425		4		ON — OFF — ON		
ET206		2	AC125V 6A AC250V 2A	ON — OFF ON — ON	Solder Terminal 	421
ET220		2	AC125V 20A AC250V 12A	ON — OFF — ON ON — (OFF) ON — (ON) ON — OFF — ON ON — (ON) (ON) — OFF — (ON) ON — OFF — (ON)	TAB #250 Screw Terminal (M4×0.7) Solder Terminal	423
ET230		2	AC125V 30A AC250V 25A	ON — OFF	Screw Terminal (M4.5×0.75) 	423
ET330		3		ON — OFF — ON	Solder Terminal 	425
ET310		3	AC125V 10A AC250V 7A	ON — OFF ON — ON ON — OFF — ON	TAB #250 Solder Terminal	424
ET410		4		ON — (ON) (ON) — OFF — (ON) ON — OFF — (ON)	Solder Terminal	425
ET410 Plate type						
ET420		4	AC125V 20A AC250V 12A	ON — OFF ON — ON ON — OFF — ON		426
ET420 Plate type				427		
ET610N Plate type		6	AC125V 10A AC250V 7A	ON — ON		427
ET620N Plate type		6	AC125V 20A AC250V 12A	ON — ON		428

● Ratings are based on resistance load.

● Refer to P.428 for UL-recognized and CSA, PSE-certified products.

(ON) and (OFF) : Momentary.

Panel Cut-Out Dimensions

● Refer to P.429 for a list of accessories.

Panel thickness : 5.5mm max.

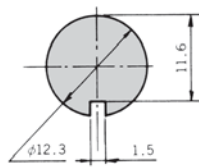
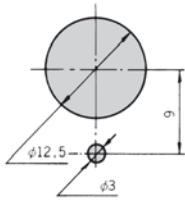

Note : Panel thickness should be 5.5 mm max. unless otherwise specified.

With **Locking Ring**

Without **Locking Ring**

ET103□32 (1 pole)

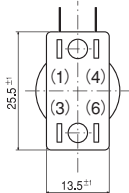
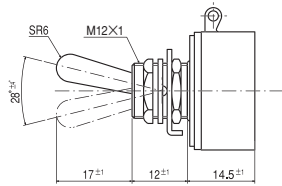
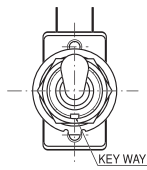

Terminal numbers are shown on the bottom of the switch.

Switching function	Key way	Key way	Key way
Part No.			
★ ET103A32-Z	ON	—	OFF
Connecting terminals	1-4	—	—
★ ET103V32-Z	ON	—	ON
Connecting terminals	1-4	—	3-6

Terminal pins No.3 and No.6 are not available in switches with Switching Function "A".

Specifications

Rating	Initial contact resistance	Dielectric strength	Insulation resistance	Electrical life
ET103A32	AC125V 3A 30mΩ Max. (DC2V 100mA)	AC1500V 1 minute	100MΩ Min. (DC500V)	10,000 cycles
ET103V32 (Cut two-wire)				

ET103□12 (1 pole)

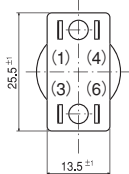
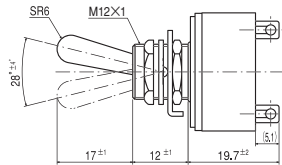
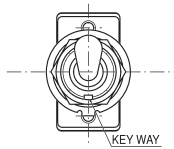

Terminal numbers are shown on the bottom of the switch.

Switching function	Key way	Key way	Key way
Part No.			
ET103A12-Z	ON	—	OFF
Connecting terminals	1-4	—	—
★ ET103V12-Z	ON	—	ON
Connecting terminals	1-4	—	3-6

Terminal pins No.3 and No.6 are not available in switches with Switching Function "A".

Specifications

Rating	Initial contact resistance	Dielectric strength	Insulation resistance	Electrical life
ET103A12	AC125V 3A 30mΩ Max. (DC2V 100mA)	AC1500V 1 minute	100MΩ Min. (DC500V)	10,000 cycles
ET103V12				

ET105□12 (1 pole)

Terminal pin No.2 is not available in switches with Switching Function "A".

L dimensions

Part No.	Terminal style	Solder Terminal
ET105A12-Z		24.6±0.1
ET105D12-Z		24.6±0.1
ET105E12-Z		24.6±0.1

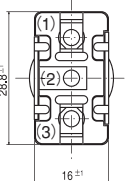
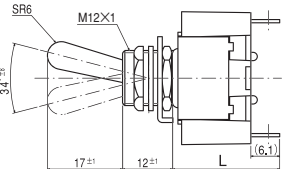
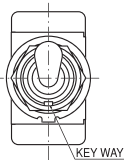

Terminal numbers are shown on the bottom of the switch.

Specifications

Rating	Initial contact resistance	Dielectric strength	Insulation resistance	Electrical life
ET105A12	AC125V 5A AC250V 3A 20mΩ Max. (DC2V 100mA)	AC1500V 1minute	100MΩ Min. (DC500V)	20,000 cycles
ET105D12				
ET105E12				

Switching function	Key way	Key way	Key way
Part No.			
☆ ET105A12-Z	ON	—	OFF
Connecting terminals	1-3	—	—
☆ ET105D12-Z	ON	—	ON
☆ ET105E12-Z	ON	OFF	ON
Connecting terminals	2-3	—	2-1

☆ : Semi-standard products. ★ : Made to order products.

ET

ET110 (1 pole)

Terminal pin No.2 is not available in switches with Switching Function "A".

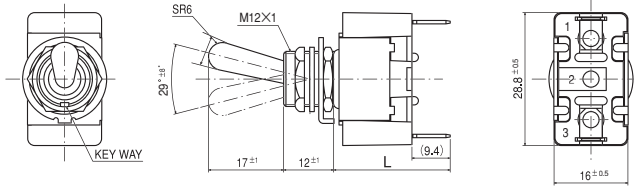

Terminal numbers are shown on the bottom of the switch.

Specifications

Rating		Initial contact resistance	Dielectric strength	Insulation resistance	Electrical life
ET110A	AC125V 10A	20mΩ Max. (DC2V 100mA)	AC1500V 1 minute	100MΩ Min. (DC500V)	30,000 cycles
ET110D	AC250V 7A				
ET110E	AC250V 7A				
ET110F	AC125V 10A	20,000 cycles			
ET110G	AC250V 7A				
ET110H	AC250V 7A				

L dimensions

Part No.	Terminal style	TAB#250	Screw Terminal	Solder Terminal
ET110A	■·D	—	—	24.6 ^{±1}
ET110E	■-Z	—	—	24.6 ^{±1}
ET110F	■-Z	27.6 ^{±1}	—	24.6 ^{±1}
ET110G	■·H	27.6 ^{±1}	25.4 ^{±1}	24.6 ^{±1}

Part No.	Switching function	Key way	Key way	Key way
ET110A	■-Z	ON	—	OFF
ET110D	■-Z	ON	—	ON
ET110E	■-Z	ON	OFF	ON
ET110F	■-Z	ON	—	(ON)
ET110G	■-Z	(ON)	OFF	(ON)
ET110H	■-Z	ON	OFF	(ON)
Connecting terminals		1-3	—	2-1

■ : Refer to "Table of Part Numbers" on P.428 for a full list of part numbers.

ET115 (1 pole)

Terminal pin No.2 is not available in switches with Switching Function "A", "B", or "C".

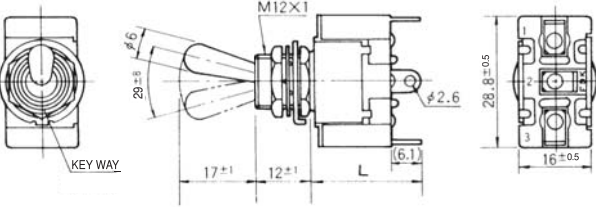

Terminal numbers are shown on the bottom of the switch.

Specifications

Rating		Initial contact resistance	Dielectric strength	Insulation resistance	Electrical life
ET115A	AC125V 15A	20mΩ Max. (DC2V 100mA)	AC1500V 1 minute	100MΩ Min. (DC500V)	30,000 cycles
ET115D	AC250V 10A				
ET115E	AC250V 10A				
ET115B	AC125V 15A	20,000 cycles			
ET115C	AC250V 10A				
ET115F	AC250V 10A				

L dimensions

Part No.	Terminal style	TAB#250	Screw Terminal	Solder Terminal
ET115A	■·D	27.6 ^{±1}	25.4 ^{±1}	24.6 ^{±1}
ET115E	■-Z	27.6 ^{±1}	25.4 ^{±1}	24.6 ^{±1}
ET115B	■-Z	—	—	24.6 ^{±1}
ET115C	■·F~H	—	25.4 ^{±1}	24.6 ^{±1}

Part No.	Switching function	Key way	Key way	Key way
ET115A	■-Z	ON	—	OFF
ET115B	■-Z	ON	—	(OFF)
ET115C	■-Z	OFF	—	(ON)
Connecting terminals		1-3	—	1-3
ET115D	■-Z	ON	—	ON
ET115E	■-Z	ON	OFF	ON
ET115F	■-Z	ON	—	(ON)
ET115G	■-Z	(ON)	OFF	(ON)
ET115H	■-Z	ON	OFF	(ON)
Connecting terminals		2-3	—	2-1

■ : Refer to "Table of Part Numbers" on P.428 for a full list of part numbers.

ET120 (1 pole)

Terminal pin No.2 is not available in switches with Switching Function "A".

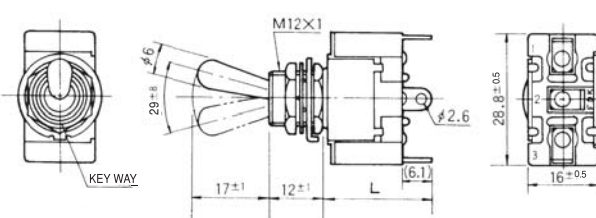

Terminal numbers are shown on the bottom of the switch.

Specifications

Rating		Initial contact resistance	Dielectric strength	Insulation resistance	Electrical life
ET120A	AC125V 20A	20mΩ Max. (DC2V 100mA)	AC1500V 1 minute	100MΩ Min. (DC500V)	20,000 cycles
ET120D	AC250V 12A				
ET120F	AC125V 20A				
ET120G	AC250V 12A				

L dimensions

Part No.	Terminal style	TAB#250	Screw Terminal	Solder Terminal
ET120A	■·D	—	—	24.6 ^{±1}
ET120F	■~H	27.6 ^{±1}	27.8 ^{±1}	24.6 ^{±1}

Part No.	Switching function	Key way	Key way	Key way
ET120A	■-Z	ON	—	OFF
ET120D	■-Z	ON	—	ON
ET120F	■-Z	ON	—	(ON)
ET120G	■-Z	(ON)	OFF	(ON)
ET120H	■-Z	ON	OFF	(ON)
Connecting terminals		2-3	—	2-1

■ : Refer to "Table of Part Numbers" on P.428 for a full list of part numbers.

(ON) : Momentary.

■ shows the terminal style "(blank)", "10", or "12".

ET

ET125 (1 pole)

Terminal pin No.2 is not available in switches with Switching Function "A".

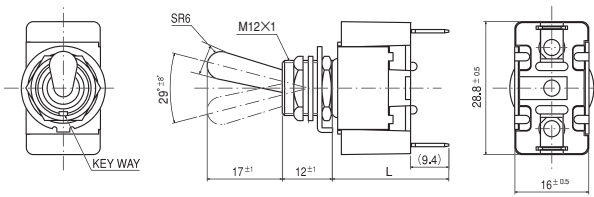

Terminal numbers are shown on the bottom of the switch.

Specifications

Rating	Initial contact resistance	Dielectric strength	Insulation resistance	Electrical life
ET125A ■ ET125D ■ ET125E ■	AC125V 25A AC250V 15A (DC2V 100mA)	AC1500V 1minute	100MΩ Min. (DC500V)	20,000 cycles

L dimensions

Terminal style	TAB#250	ScrewTerminal	Solder Terminal
Part No. ET125A ■-Z	27.6±1	28.8±1	24.6±1
Part No. ET125D ■-Z	—	28.8±1	24.6±1
Part No. ET125E ■-Z	—	28.8±1	24.6±1

Switching function	Key way	Key way	Key way
Part No. ET125A ■-Z	ON	—	OFF
Connecting terminals	1-3	—	—
Part No. ET125D ■-Z	ON	—	ON
Part No. ET125E ■-Z	ON	OFF	ON
Connecting terminals	2-3	—	2-1

■ : Refer to "Table of Part Numbers" on P.428 for a full list of part numbers.

ET205 (2 poles)

Terminal pins No.2 and No.5 are not available in switches with Switching Function "K".

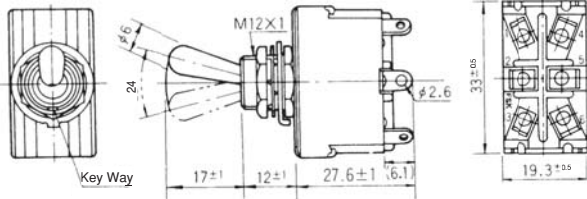

Terminal numbers are shown on the bottom of the switch.

Specifications

Rating	Initial contact resistance	Dielectric strength	Insulation resistance	Electrical life
ET205K12 ■ ET205N12 ■ ET205P12 ■	AC125V 5A AC250V 3A (DC2V 100mA)	AC1500V 1 minute	100MΩ Min. (DC500V)	20,000 cycles

Switching function	Key way	Key way	Key way
Part No. ET205K12 -Z	ON	—	OFF
Connecting terminals	1-3 4-6	—	—
Part No. ET205N12 -Z	ON	—	ON
Part No. ET205P12 -Z	ON	OFF	ON
Connecting terminals	2-3 5-6	—	2-1 5-4

ET206 □12 (2 poles)

Terminal pins No.3 and No.6 are not available in switches with Switching Function "K".

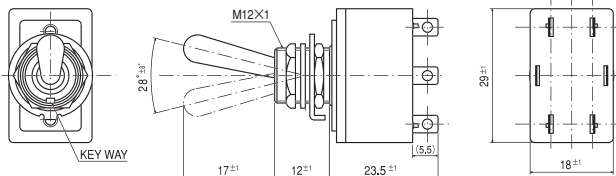

Terminal numbers are shown on the bottom of the switch.

Specifications

Rating	Initial contact resistance	Dielectric strength	Insulation resistance	Electrical life
ET206K12 ■	AC125V 6A (DC2V 100mA)	AC1500V minute	100MΩ Min. (DC500V)	10,000 cycles
ET206N12 ■	AC125V 6A AC250V 2A			

Switching function	Key way	Key way	Key way
Part No. ET206K12 -Z	ON	—	OFF
Connecting terminals	2-1 5-4	—	—
Part No. ET206N12 -Z	ON	—	ON
Connecting terminals	2-1 5-4	—	2-3 5-6

■ shows the terminal style "(blank)", "10", or "12".

☆ : Semi-standard products.

★ : Made to order products.

ET

ET210 (2 poles)

Terminal pins No.2 and No.5 are not available in switches with Switching Function "K".

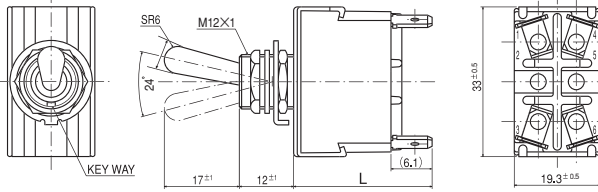
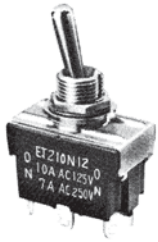

Terminal numbers are shown on the bottom of the switch.

Specifications

Rating		Initial contact resistance	Dielectric strength	Insulation resistance	Electrical life
ET210K	AC125V 10A	20mΩ Max. (DC2V 100mA)	AC1500V 1 minute	100MΩ Min. (DC500V)	30,000 cycles
ET210N	AC250V 7A				
ET210P					
ET210R	AC125V 10A	20,000 cycles			
ET210S	AC250V 7A				
ET210T					
ET210PA12	AC125V 10A				

L dimensions

Part No.	Terminal style		
	TAB#250	ScrewTerminal	Solder Terminal
ET210K■·N■-Z	30.6 ^{±1}	28.4 ^{±1}	27.6 ^{±1}
ET210P■-Z	30.6 ^{±1}	28.4 ^{±1}	27.6 ^{±1}
ET210R■~T■-Z	30.6 ^{±1}	28.4 ^{±1}	27.6 ^{±1}
ET210PA12■-Z	—	—	27.6 ^{±1}

Part No.	Switching function		
	Key way	Key way	Key way
ET210K■-Z	ON	—	OFF
ET210N■-Z	ON	—	ON
ET210P■-Z	ON	OFF	ON
ET210R■-Z	ON	—	(ON)
ET210S■-Z	(ON)	OFF	(ON)
ET210T■-Z	ON	OFF	(ON)
Connecting terminals	1-3 4-6	—	—
★ ET210PA12-Z	ON	ON	OFF
Connecting terminals	2-3 5-6	5-6	—

■ : Refer to "Table of Part Numbers" on P.428 for a full list of part numbers.of part numbers.

ET215 (2 poles)

Terminal pins No.2 and No.5 are not available in switches with Switching Function "K", "L", or "M".

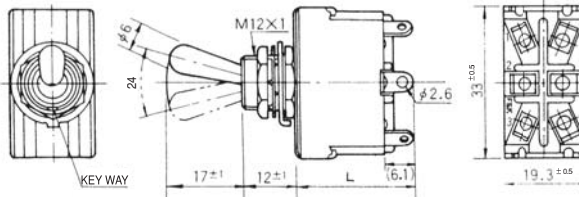

Terminal numbers are shown on the bottom of the switch.

Specifications

Rating		Initial contact resistance	Dielectric strength	Insulation resistance	Electrical life
ET215K	AC125V 15A	20mΩ Max. (DC2V 100mA)	AC1500V 1 minute	100MΩ Min. (DC500V)	30,000 cycles
ET215N	AC250V 10A				
ET215P					
ET215L	AC125V 15A	20,000 cycles			
ET215M	AC250V 10A				
ET215R					
ET215S					
ET215T					

L dimensions

Part No.	Terminal style		
	TAB#250	ScrewTerminal	Solder Terminal
ET215K■·N■-Z	30.6 ^{±1}	28.4 ^{±1}	27.6 ^{±1}
ET215P■-Z	30.6 ^{±1}	28.4 ^{±1}	27.6 ^{±1}
ET215 ^{L, M, R, T} ■-Z	—	28.4 ^{±1}	27.6 ^{±1}

Part No.	Switching function		
	Key way	Key way	Key way
ET215K■-Z	ON	—	OFF
ET215L■-Z	ON	—	(OFF)
ET215M■-Z	OFF	—	(ON)
Connecting terminals	1-3 4-6	—	—
Connecting terminals	—	—	1-3 4-6
ET215N■-Z	ON	—	ON
ET215P■-Z	ON	OFF	ON
ET215R■-Z	ON	—	(ON)
ET215S■-Z	(ON)	OFF	(ON)
ET215T■-Z	ON	OFF	(ON)
Connecting terminals	2-3 5-6	—	2-1 5-4

■ : Refer to "Table of Part Numbers" on P.428 for a full list of part numbers.of part numbers.

(ON) and (OFF) : Momentary.

■ shows the terminal style "(blank)", "10", or "12".

ET

ET220 (2 poles)

Terminal pins No.2 and No.5 are not available in switches with Switching Function "K", "L", or "M".

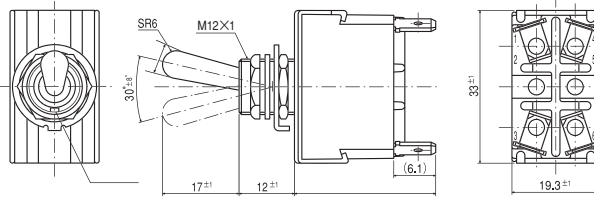

Terminal numbers are shown on the bottom of the switch.

Specifications

Rating		Initial contact resistance	Dielectric strength	Insulation resistance	Electrical life
ET220K	AC125V 20A	20mΩ Max. (DC2V 100mA)	AC1500V 1 minute	100MΩ Min. (DC500V)	20,000 cycles
ET220N	AC250V 12A				
ET220P					
ET220L	AC125V 20A AC250V 12A	20mΩ Max. (DC2V 100mA)	AC1500V 1 minute	100MΩ Min. (DC500V)	20,000 cycles
ET220M					
ET220R					
ET220S					
ET220T					

L dimensions

Terminal style	TAB#250	ScrewTerminal	Solder Terminal
Part No.			
ET220K- N -Z	—	—	27.6 ^{±1}
ET220P- Z	—	—	27.6 ^{±1}
ET220R- ~T -Z	30.6 ^{±1}	30.8 ^{±1}	27.6 ^{±1}
ET220M- Z	—	—	27.6 ^{±1}

Switching function	Key way	Key way	Key way
Part No.			
ET220K- Z	ON	—	OFF
Connecting terminals	1-3 4-6	—	—
ET220M- Z	OFF	—	(ON)
Connecting terminals	—	—	1-3 4-6
ET220N- Z	ON	—	ON
ET220P- Z	ON	OFF	ON
ET220R- Z	ON	—	(ON)
ET220S- Z	(ON)	OFF	(ON)
ET220T- Z	ON	OFF	(ON)
Connecting terminals	2-3 5-6	—	2-1 5-4

■ : Refer to "Table of Part Numbers" on P.428 for a full list of part numbers.

ET225 (2 poles)

Terminal pins No.2 and No.5 are not available in switches with Switching Function "K".

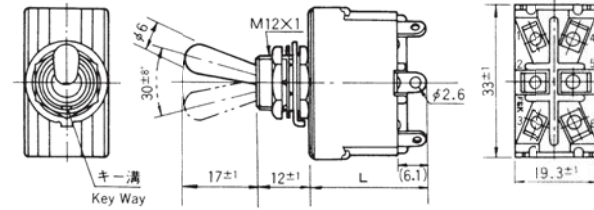
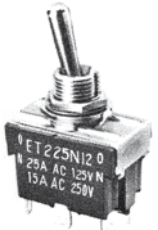

Terminal numbers are shown on the bottom of the switch.

Specifications

Rating		Initial contact resistance	Dielectric strength	Insulation resistance	Electrical life
ET225K	AC125V 25A	20mΩ Max. (DC2V 100mA)	AC1500V 1 minute	100MΩ Min. (DC500V)	20,000 cycles
ET225N	AC250V 15A				
ET225P					

L dimensions

Terminal style	TAB#250	ScrewTerminal	Solder Terminal
Part No.			
ET225K- N -Z	30.6 ^{±1}	31.8 ^{±1}	27.6 ^{±1}
ET225P- Z			

Switching function	Key way	Key way	Key way
Part No.			
ET225K- Z	ON	—	OFF
Connecting terminals	1-3 4-6	—	—
ET225N- Z	ON	—	ON
ET225P- Z	ON	OFF	ON
Connecting terminals	2-3 5-6	—	2-1 5-4

■ : Refer to "Table of Part Numbers" on P.428 for a full list of part numbers.

ET230 (2 poles)

Terminal pins No.2 and No.5 are not available in switches with Switching Function "K".

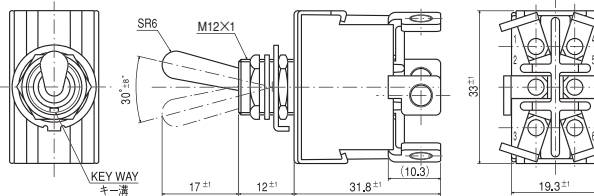
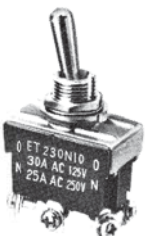

Terminal numbers are shown on the bottom of the switch.

Specifications

Rating		Initial contact resistance	Dielectric strength	Insulation resistance	Electrical life
ET230N10	AC250V 25A	20mΩ Max. (DC2V 100mA)	AC1500V 1minute	100MΩ Min. (DC500V)	20,000 cycles
ET230P10	AC125V 30A				

Switching function	Key way	Key way	Key way
Part No.			
★ ET230N- Z	ON	—	ON
★ ET230P- Z	ON	OFF	ON
Connecting terminals	2-3 5-6	—	2-1 5-4

(ON) : Momentary.

■ shows the terminal style "(blank)", "10", or "12".

★ : Made to order products.

ET

ET310 (3 poles)

Terminal pins No.2, No.5, and No.8 are not available in switches with Switching Function "A".

L dimensions

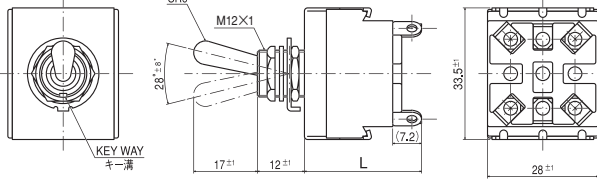
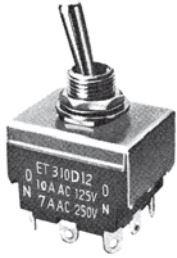

Terminal numbers are shown on the bottom of the switch.

Terminal style	TAB#250	Screw Terminal	Solder Terminal
Part No.			
ET310A- Z	34 ^{±2}	—	29.1 ^{±1}
ET310D- Z	36.4 ^{±1}	—	29.1 ^{±1}
ET310E- Z			

Switching function	Key way	Key way	Key way
Part No.			
ET310A- Z	ON	—	OFF
Connecting terminals	1-3 4-6 7-9	—	—
ET310D- Z	ON	—	ON
ET310E- Z	ON	OFF	ON
Connecting terminals	2-3 5-6 8-9	—	2-1 5-4 8-7

Specifications

Rating	Initial contact resistance	Dielectric strength	Insulation resistance	Electrical life
ET310A- Z	20mΩ Max. (DC2V 100mA)	AC1500V 1minute	100MΩ Min. (DC500V)	20,000 cycles
ET310D- Z				
ET310E- Z	AC250V 7A			

■ : Refer to "Table of Part Numbers" on P.428 for a full list of part numbers.

ET315 12 (3 poles)

Terminal pins No.2, No.5, and No.8 are not available in switches with Switching Function "A".

Switching function	Key way	Key way	Key way
Part No.			
★ET315A12-Z	ON	—	OFF
Connecting terminals	1-3 4-6 7-9	—	—
★ET315D12-Z	ON	—	ON
★ET315E12-Z	ON	OFF	ON
★ET315F12-Z	ON	—	(ON)
★ET315G12-Z	(ON)	OFF	(ON)
★ET315H12-Z	ON	OFF	(ON)
Connecting terminals	2-3 5-6 8-9	—	2-1 5-4 8-7

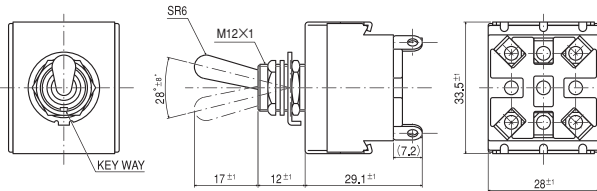

Terminal numbers are shown on the bottom of the switch.

Specifications

Rating	Initial contact resistance	Dielectric strength	Insulation resistance	Electrical life
ET315A12	20mΩ Max. (DC2V 100mA)	AC1500V 1minute	100MΩ Min. (DC500V)	20,000 cycles
ET315D12				
ET315E12	AC125V 15A			
ET315F12	AC250V 10A			
ET315G12	AC125V 15A			
ET315H12	AC250V 10A			

ET325 12 (3 poles)

Terminal pins No.2, No.5, and No.8 are not available in switches with Switching Function "A".

Switching function	Key way	Key way	Key way
Part No.			
★ET325A12-Z	ON	—	OFF
Connecting terminals	1-3 4-6 7-9	—	—
★ET325D12-Z	ON	—	ON
★ET325E12-Z	ON	OFF	ON
Connecting terminals	2-3 5-6 8-9	—	2-1 5-4 8-7

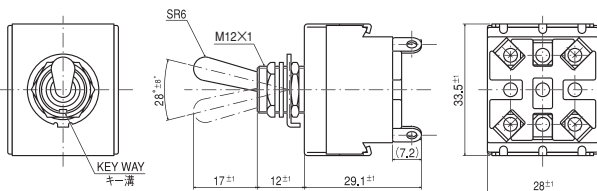
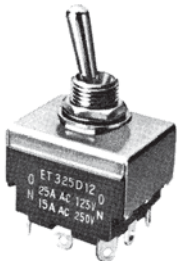

Terminal numbers are shown on the bottom of the switch.

Specifications

Rating	Initial contact resistance	Dielectric strength	Insulation resistance	Electrical life
ET325A12	20mΩ Max. (DC2V 100mA)	AC1500V 1 minute	100MΩ Min. (DC500V)	20,000 cycles
ET325D12				
ET325E12	AC125V 25A			
	AC250V 15A			

★ : Made to order products.

(ON) : Momentary.

■ shows the terminal style "(blank)" or "12".

ET330□12 (3 poles)

Terminal pins No.2, No.5, and No.8 are not available in switches with Switching Function "A".

L dimensions

Terminal style	TAB#250	Screw Terminal	Solder Terminal
Part No.			
ET330A ■-Z	33.9 ^{±2}	—	29.1 ^{±1}
ET330D12-Z	—	—	—
ET330E12-Z	—	—	—

Switching function	Key way	Key way	Key way
Part No.			
ET330A ■-Z	ON	—	OFF
Connecting terminals	1-3 4-6 7-9	—	—
☆ ET330D12-Z	ON	—	ON
★ ET330E12-Z	ON	OFF	ON
Connecting terminals	2-3 5-6 8-9	—	2-1 5-4 8-7

■ : Refer to "Table of Part Numbers" on P.428 for a full list of part numbers.

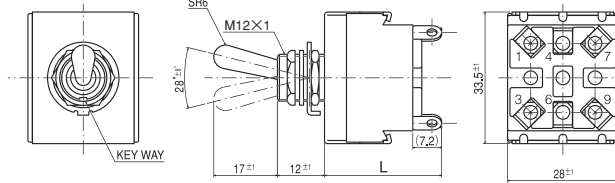
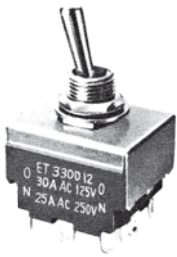

Terminal numbers are shown on the bottom of the switch.

Specifications

Rating	Initial contact resistance	Dielectric strength	Insulation resistance	Electrical life
ET330A ■ ET330D12 ET330E12	AC125V 30A AC250V 25A (DC2V 100mA)	AC1500V 1 minute	100MΩ Min. (DC500V)	20,000 cycles

ET410□12 (4 poles)

Terminal pins No.2, No.5, No.8, and No.11 are not available in switches with Switching Function "K".

Switching function	Key way	Key way	Key way
Part No.			
★ ET410K12-Z	ON	—	OFF
Connecting terminals	1-3 4-6 7-9 10-12	—	—
★ ET410N12-Z	ON	—	ON
★ ET410P12-Z	ON	OFF	ON
★ ET410R12-Z	ON	—	(ON)
★ ET410S12-Z	(ON)	OFF	(ON)
▲ ET410T12-Z	ON	OFF	(ON)
Connecting terminals	2-3 5-6 8-9 11-12	—	2-1 5-4 8-7 11-10

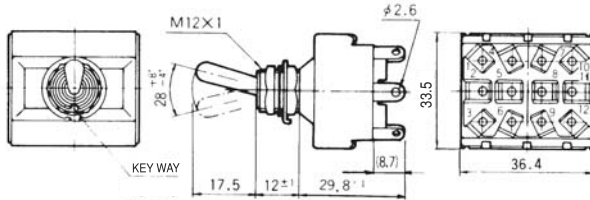

Terminal numbers are shown on the bottom of the switch.

Specifications

Rating	Initial contact resistance	Dielectric strength	Insulation resistance	Electrical life
ET410K12 ET410N12 ET410P12	AC125V 10A AC250V 7A	AC1500V 1 minute	100MΩ Min. (DC500V)	20,000 cycles
ET410R12 ET410S12 ET410T12	AC125V 10A AC250V 7A			

ET410□13 (4 poles)

Switching function	Viewed from part No. and rating marking side		
Part No.			
★ ET410R13-Z	ON	—	(ON)
Connecting terminals	2-3 5-6 8-9 11-12	—	2-1 5-4 8-7 11-10

Panel Cut-Out Dimensions

(Plate mounting type)

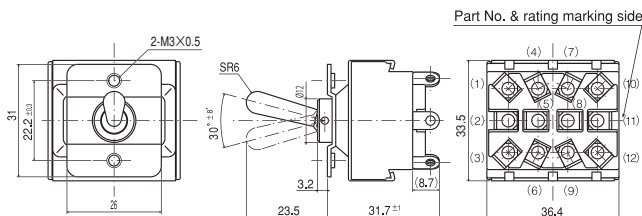
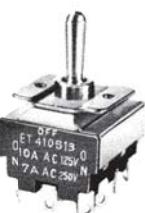

Terminal numbers are shown on the bottom of the switch.

Specifications

Rating	Initial contact resistance	Dielectric strength	Insulation resistance	Electrical life
ET410R13	AC125V 10A AC250V 7A (DC2V 100mA)	AC1500V 1 minute	100MΩ Min. (DC500V)	20,000 cycles



ET

ET415□12 (4 poles)

Terminal pins No.2, No.5, No.8, and No.11 are not available in switches with Switching Function "K".

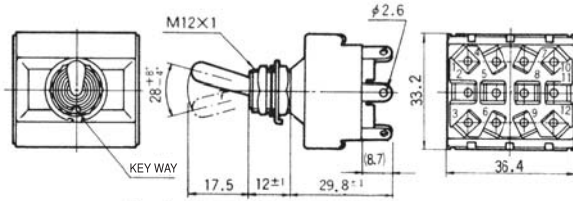

Terminal numbers are shown on the bottom of the switch.

Switching function	Key way	Key way	Key way
Part No.			
★ET415K12-Z	ON	—	OFF
Connecting terminals	1-3 4-6 7-9 10-12	—	—
★ET415N12-Z	ON	—	ON
★ET415P12-Z	ON	OFF	ON
Connecting terminals	2-3 5-6 8-9 11-12	—	2-1 5-4 8-7 11-10

Specifications

Rating	Initial contact resistance	Dielectric strength	Insulation resistance	Electrical life
ET415K12 ET415N12 ET415P12	AC125V 15A AC250V 10A	20mΩ Max. (DC2V 100mA)	AC1500V 1minute (DC500V)	100MΩ Min. (DC500V) 20,000 cycles

ET415□13 (4 poles)

Terminal pins No.2, No.5, No.8, and No.11 are not available in switches with Switching Function "K".

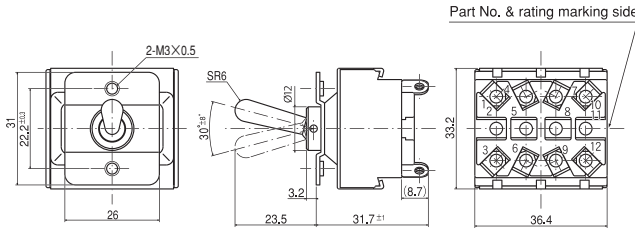

Terminal numbers are shown on the bottom of the switch.

Switching function	Viewed from part No. and rating marking side		
Part No.			
★ET415K13-Z	ON	—	OFF
Connecting terminals	1-3 4-6 7-9 10-12	—	—
★ET415N13-Z	ON	—	ON
▲ET415P13-Z	ON	OFF	ON
Connecting terminals	2-3 5-6 8-9 11-12	—	2-1 5-4 8-7 11-10

Specifications

Rating	Initial contact resistance	Dielectric strength	Insulation resistance	Electrical life
ET415K13 ET415N13 ET415P13	AC125V 15A AC250V 10A	20mΩ Max. (DC2V 100mA)	AC1500V 1minute (DC500V)	100MΩ Min. (DC500V) 20,000 cycles

Panel Cut-Out Dimensions

(Plate mounting type)



ET420□12 (4 poles)

Terminal pins No.2, No.5, No.8, and No.11 are not available in switches with Switching Function "K".

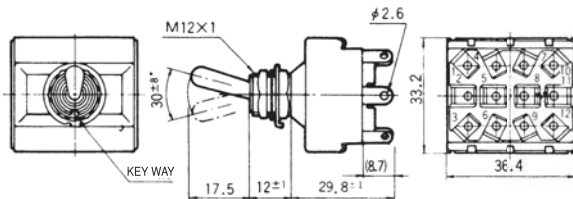
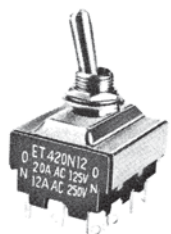

Terminal numbers are shown on the bottom of the switch.

Switching function	Key way	Key way	Key way
Part No.			
★ET420K12-Z	ON	—	OFF
Connecting terminals	1-3 4-6 7-9 10-12	—	—
★ET420N12-Z	ON	—	ON
★ET420P12-Z	ON	OFF	ON
Connecting terminals	2-3 5-6 8-9 11-12	—	2-1 5-4 8-7 11-10

Specifications

Rating	Initial contact resistance	Dielectric strength	Insulation resistance	Electrical life
ET420K12 ET420N12 ET420P12	AC125V 20A AC250V 12A	20mΩ Max. (DC2V 100mA)	AC1500V 1minute (DC500V)	100MΩ Min. (DC500V) 20,000 cycles

★ : Made to order products. ▲ : Inquiry products.

ET

ET420□13 (4 poles)

Terminal pins No.2, No.5, No.8, and No.11 are not available in switches with Switching Function "K".

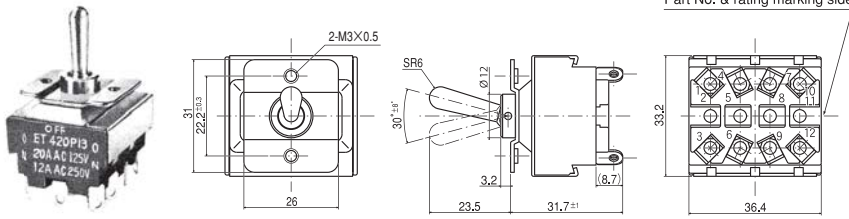

Terminal numbers are shown on the bottom of the switch.

Switching function	Viewed from part No. and rating marking side		
Part No.	★ET420K13-Z	—	OFF
Connecting terminals	1-3 4-6 7-9 10-12	—	—
Part No.	★ET420N13-Z	—	ON
Part No.	★ET420P13-Z	OFF	ON
Connecting terminals	2-3 5-6 8-9 11-12	—	2-1 5-4 8-7 11-10

Specifications

Rating	Initial contact resistance	Dielectric strength	Insulation resistance	Electrical life
ET420K13 ET420N13 ET420P13	AC125V 20A AC250V 12A (DC2V 100mA)	20mΩ Max. AC1500V 1minute	100MΩ Min. (DC500V)	20,000 cycles

Panel Cut-Out Dimensions

(Plate mounting type)

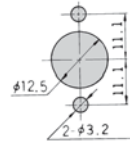

ET425□12 (4 poles)

Terminal pins No.2, No.5, No.8, and No.11 are not available in switches with Switching Function "K".

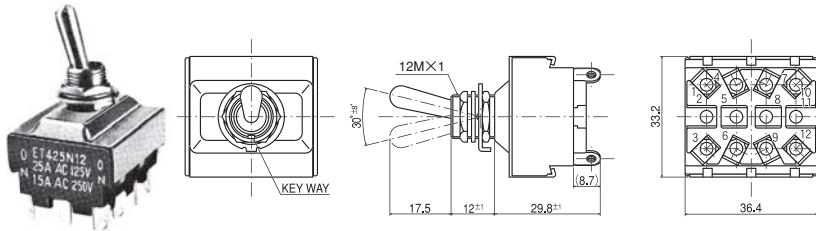

Terminal numbers are shown on the bottom of the switch.

Switching function	Key way	Key way	Key way
Part No.	★ET425K12-Z	—	OFF
Connecting terminals	1-3 4-6 7-9 10-12	—	—
Part No.	★ET425N12-Z	—	ON
Part No.	★ET425P12-Z	OFF	ON
Connecting terminals	2-3 5-6 8-9 11-12	—	2-1 5-4 8-7 11-10

Specifications

Rating	Initial contact resistance	Dielectric strength	Insulation resistance	Electrical life
ET425K12 ET425N12 ET425P12	AC125V 25A AC250V 15A (DC2V 100mA)	20mΩ Max. AC1500V 1minute	100MΩ Min. (DC500V)	20,000 cycles

ET610N13 (6 poles)

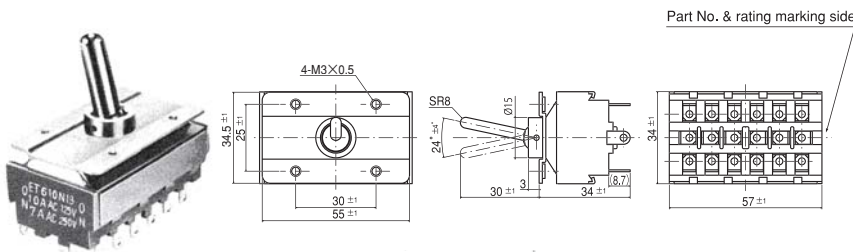

Terminal numbers are shown on the bottom of the switch.

Switching function	Viewed from part No. and rating marking side		
Part No.	☆ET610N13-Z	—	ON
Connecting terminals	2-3 5-6 8-9 11-12 14-15 17-18	—	2-1 5-4 8-7 11-10 14-13 17-16

Panel Cut-Out Dimensions

(Plate mounting type)

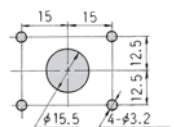

Specifications

Rating	Initial contact resistance	Dielectric strength	Insulation resistance	Electrical life
ET610N13	AC125V 10A AC250V 7A (DC2V 100mA)	20mΩ Max. AC1500V 1 minute	100MΩ Min. (DC500V)	5,000 cycles

☆ : Semi-standard products. ★ : Made to order products.

ET620N13 (6 poles)

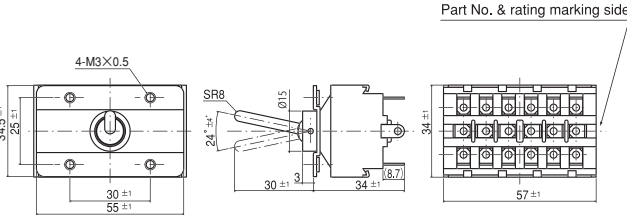
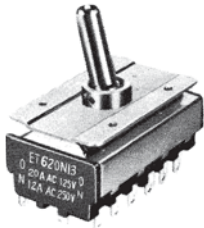

Terminal numbers are shown on the bottom of the switch.

Switching function	Viewed from part No. and rating marking side		
Part No.	★ET620N13-Z	—	ON
Connecting terminals	2-3 5-6 8-9 11-12 14-15 17-18	—	2-1 5-4 8-7 11-10 14-13 17-16

Panel Cut-Out Dimensions

Specifications

Rating		Initial contact resistance	Dielectric strength	Insulation resistance	Electrical life
ET620N13	AC125V 20A AC250V 12A	20mΩ Max. (DC2V 100mA)	AC1500V 1 minute	100MΩ Min. (DC500V)	5,000 cycles

(Plate mounting type)

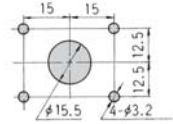

UL•CSA/PS/ Table of Part Numbers

Terminal Style	Part No.	※1.	Part No.	※1.	Part No.	※1.	Part No.	※1.
TAB terminals	★ ET110F-Z		—		★ ET215N-Z	40.0	ET225P-Z	
	★ ET110G-Z		★ ET120G-Z		☆ ET215P-Z	39.7	▲ ET310E-Z	
	★ ET110H-Z		★ ET125A-Z	26.6	★ ET220R-Z		★ ET330A-Z	
	☞ ET115A-Z	29.4	▲ ET125D-Z		★ ET220S-Z		—	—
	★ ET115D-Z		★ ET210S-Z		☆ ET225K-Z	39.4	—	—
	★ ET115E-Z		★ ET215K-Z	39.3	★ ET225N-Z		—	—
Screw terminals	★ ET110G10-Z		★ ET120G10-Z		★ ET215L10-Z		★ ET225N10-Z	
	☆ ET115A10-Z		★ ET125A10-Z		▲ ET215R10-Z		★ ET225P10-Z	
	★ ET115C10-Z		★ ET125D10-Z		★ ET215S10-Z		—	—
	★ ET115D10-Z		—		▲ ET215T10-Z		★ ET230N10-Z	54.4
	★ ET115E10-Z		★ ET215K10-Z		★ ET220R10-Z	53.6	★ ET230P10-Z	
	★ ET115F10-Z		☆ ET215N10-Z		★ ET220S10-Z		—	—
	▲ ET115H10-Z		★ ET215P10-Z		★ ET225K10-Z		—	—
Solder terminals	☞ ET103A12-Z	21.0	★ ET125D12-Z	26.0	★ ET220P12-Z		★ ET410R13-Z	56.9
	★ ET103A32-Z	21.0	★ ET125E12-Z		★ ET220R12-Z		★ ET410S12-Z	
	★ ET103V12-Z	21.0	★ ET205K12-Z		★ ET220S12-Z		▲ ET410T12-Z	
	★ ET103V32-Z		★ ET205N12-Z		★ ET220T12-Z		★ ET415K12-Z	
	☆ ET105A12-Z		★ ET205P12-Z		☆ ET225K12-Z	38.1	★ ET415K13-Z	57.6
	☆ ET105D12-Z	25.8	☞ ET206K12-Z	26.1	ET225N12-Z	38.6	★ ET415N12-Z	56.8
	☆ ET105E12-Z		☆ ET206N12-Z	26.3	ET225P12-Z		★ ET415N13-Z	
	☆ ET110A12-Z	25.8	☆ ET210K12-Z		★ ET310A12-Z	54.0	★ ET415P12-Z	
	☆ ET110D12-Z		☆ ET210N12-Z	38.0	☆ ET310D12-Z	54.6	▲ ET415P13-Z	
	★ ET110E12-Z		☆ ET210P12-Z	37.9	☆ ET310E12-Z		★ ET420K12-Z	
	★ ET110F12-Z		★ ET210R12-Z		★ ET315A12-Z		★ ET420K13-Z	
	★ ET110G12-Z		★ ET210S12-Z		★ ET315D12-Z	54.7	★ ET420N12-Z	
	☞ ET115A12-Z	25.9	★ ET210T12-Z		★ ET315E12-Z		★ ET420N13-Z	
	★ ET115B12-Z		★ ET210PA12-Z		★ ET315F12-Z		★ ET420P12-Z	
	★ ET115C12-Z		☆ ET215K12-Z	37.9	★ ET315G12-Z		★ ET420P13-Z	55.0
	☞ ET115D12-Z	25.9	▲ ET215L12-Z		★ ET315H12-Z		★ ET425K12-Z	
	★ ET115E12-Z	25.9	★ ET215M12-Z		★ ET325A12-Z		★ ET425N12-Z	
	★ ET115F12-Z		☆ ET215N12-Z	38.1	★ ET325D12-Z		★ ET425P12-Z	106.0
	★ ET115G12-Z		★ ET215P12-Z	37.8	★ ET325E12-Z		☆ ET610N13-Z	105.0
	★ ET115H12-Z	25.0	★ ET215R12-Z		★ ET330A12-Z		★ ET620N13-Z	
	☆ ET120A12-Z		ET215S12-Z	38.4	☆ ET330D12-Z	54.2	—	—
	★ ET120D12-Z		★ ET215T12-Z		★ ET330E12-Z		—	—
	▲ ET120F12-Z		★ ET220K12-Z		★ ET410K12-Z	56.5	—	—
	★ ET120G12-Z		—		★ ET410N12-Z	57.4	—	—
	★ ET120H12-Z		▲ ET220M12-Z		★ ET410P12-Z		—	—
	☆ ET125A12-Z	25.9	★ ET220N12-Z		★ ET410R12-Z	56.5	—	—

As shown in the above table, not all products are UL-recognized or CSA-certified. Please check with your local sales representative if you have any questions.
Note: For overseas standards, see P.627.

※1 : Switch mass (g) : includes accessories = hex nut, locking ring, lock washer and terminal screw

★ : Made to order products. ☆ : Semi-standard products. ▲ : Inquiry products.

Electrical Appliance and Material Safety Law Listed Products

Circuit	Part No.	For appliances				License number model	Circuit	Part No.	For appliances				License number model					
		For general appliances		For motors	For electronic appliances				For general appliances		For motors	For electronic appliances						
		AC125V	AC250V	AC125V	AC125V				AC125V	AC250V	AC125V	AC125V						
SPDT	ET110G10-Z	10A	7A	—	—	◇41-10290	SPST	ET115A10-Z	15A	10A	400W	2A	◇41-15368					
	ET115C10-Z	—	—	—	—	◇41-10665		ET115E10-Z			—	—	—	—	◇41-15369			
	ET115D10-Z	15A	10A	—	—	◇41-10665	DPST	ET125A10-Z	25A	15A	750W	5A	◇41-15370					
	ET115E10-Z							—	—	—	—	◇41-15338	ET215K10-Z	15A	10A	400W	2A	◇41-15370
	ET115F10-Z							—	—	—	—	◇41-10296	ET215L10-Z	15A	10A	—	—	◇41-10296
	ET115H10-Z	20A	12A	—	—	◇41-10463	—	ET225K10-Z	25A	15A	750W	5A	◇41-15371					
	ET120G10-Z							—	—	—	—	—	—	—	—	—	—	
	ET125D10-Z	25A	15A	750W	5A	◇41-15369	—	—	—	—	—	—	—					

Standard Accessories

《Supplied with switch》

Part Name	Hex Nut	Hex Nut	Lockwasher	Locking Ring
Part No.	140008010235	140008010221	140008030055	140008020065
Dimensions				
Finish	Nickel plated	Zinc plated	Zinc plated	Zinc plated

ET115 ET215	140000080639	140008030057
ET120 ET220	140000080651	140008030058
ET125 ET225 ET230	140000080652	140008030060

Optional Accessories

《Supplied separately》

Type	ET · 8B		ET	ET	
Part Name	Plate	Plate	Waterproof boot	Boot	Bushing
Part No.	140008040021	140008040025	Red 140000610335 Gray 140000610334 Black 140000610333	140000610080	140008010244
Dimensions					

Type	ET
Part Name	Hex Nut
Part No.	140008010238
Dimensions	 Chromium

(2) Waterproof boot

- ① The boot is fixed to the switch with the built-in screw.
- ② The boot cannot be used for plate-mounting switches.

2. Flux Cleaning

- (1) Solvent : Fluorine or Alcohol type.
- (2) The ET series are not washable. To wash the PC board, clean the soldering surface of the PC board with a brush so that the switch is not exposed to the cleaning solution.

Packaging Specification

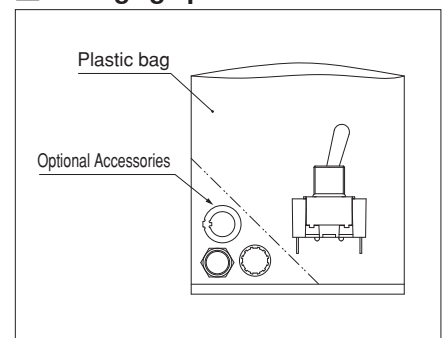

Handling Precautions

1. Soldering Specifications

(1) Manual Soldering

Device : Soldering iron
420°C, Max.; 3 seconds, Max.