

Features

- Glass Passivated Die Construction
- Ideally Suited for Automatic Assembly
- Low Profile Package
- High Surge Current Capability
- Low Power Loss, High Efficiency
- Super-Fast Recovery Time
- Plastic Case Material has UL Flammability Classification Rating 94V-O

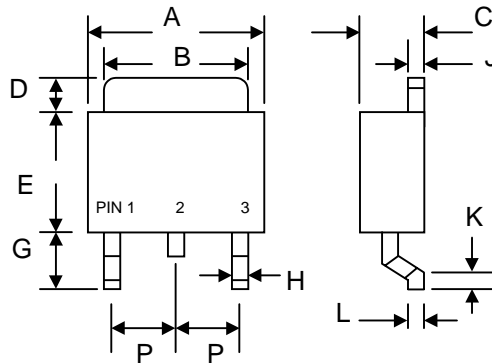

Mechanical Data

- Case: Molded Plastic
- Terminals: Plated Leads Solderable per MIL-STD-750, Method 2026
- Polarity: Cathode Band
- Weight: 0.4 grams (approx.)
- Mounting Position: Any
- Marking: Type Number
- Standard Packaging: 16mm Tape (EIA-481)

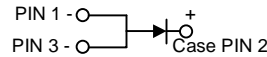

D PAK/TO-252AA		
Dim	Min	Max
A	6.4	6.8
B	5.0	5.4
C	2.35	2.75
D	—	1.60
E	5.3	5.7
G	2.3	2.7
H	0.4	0.8
J	0.4	0.6
K	0.3	0.7
L	0.50 Typical	
P	—	2.3
All Dimensions in mm		

Maximum Ratings and Electrical Characteristics @T_A=25°C unless otherwise specified

Single Phase, half wave, 60Hz, resistive or inductive load. For capacitive load, derate current by 20%.

Characteristic	Symbol	ED502YS	ED503YS	ED504YS	ED506YS	Unit
Peak Repetitive Reverse Voltage	V _{RRM}					
Working Peak Reverse Voltage	V _{RWM}	200	300	400	600	V
DC Blocking Voltage	V _R					
RMS Reverse Voltage	V _{R(RMS)}	140	210	280	420	V
Average Rectified Output Current @T _L = 75°C	I _O	5.0				A
Non-Repetitive Peak Forward Surge Current 8.3ms Single half sine-wave superimposed on rated load (JEDEC Method)	I _{FSM}	75				A
Forward Voltage (Note 1) @I _F = 5.0A	V _{FM}	0.95	1.25		1.7	V
Peak Reverse Current @T _A = 25°C	I _{RM}	5.0				μA
At Rated DC Blocking Voltage @T _A = 100°C		200				
Typical Thermal Resistance Junction to Ambient	R _{θJA}	71				K/W
Reverse Recovery Time (Note 2)	t _{rr}	35				nS
Operating and Storage Temperature Range	T _J , T _{STG}	-50 to +150				°C

Note: 1. Mounted on P.C. Board with 14mm² (0.13mm thick) copper pad.
 2. Measured with I_F = 0.5A, I_R = 1.0A, I_{rr} = 0.25A.

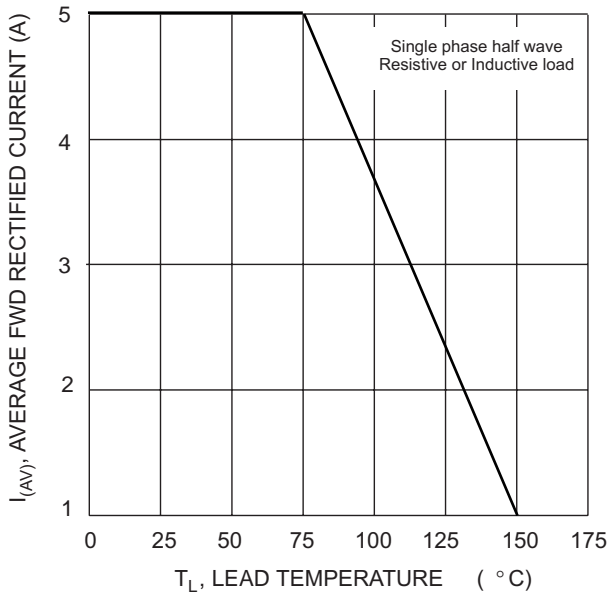

Fig. 1 Forward Current Derating Curve

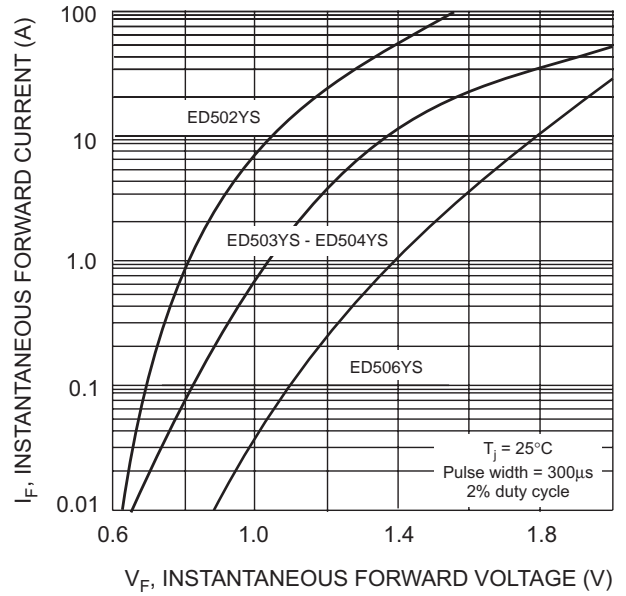

Fig. 2 Typical Forward Characteristics

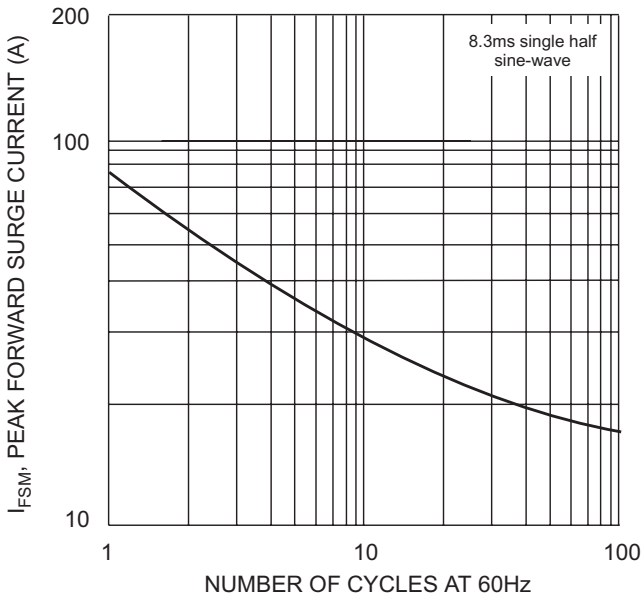

Fig. 3 Peak Forward Surge Current

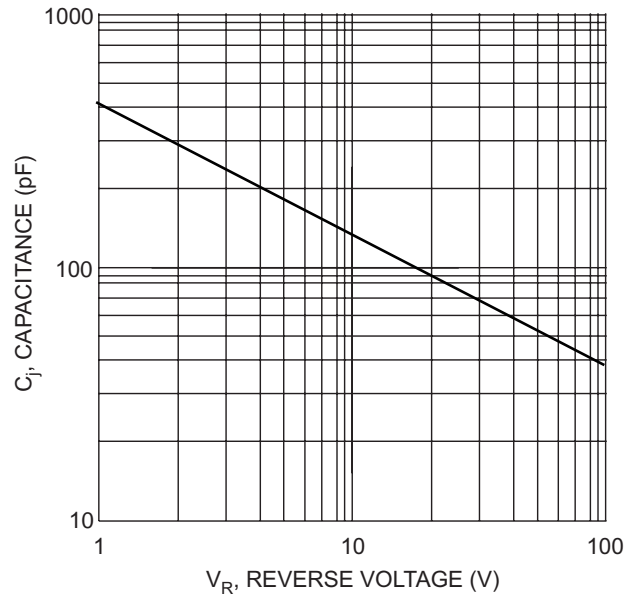
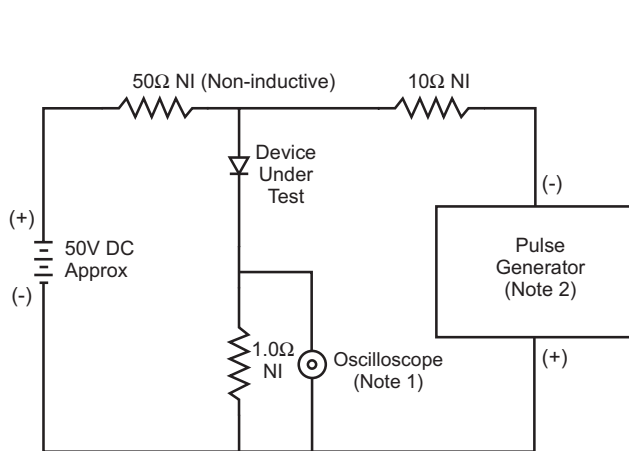
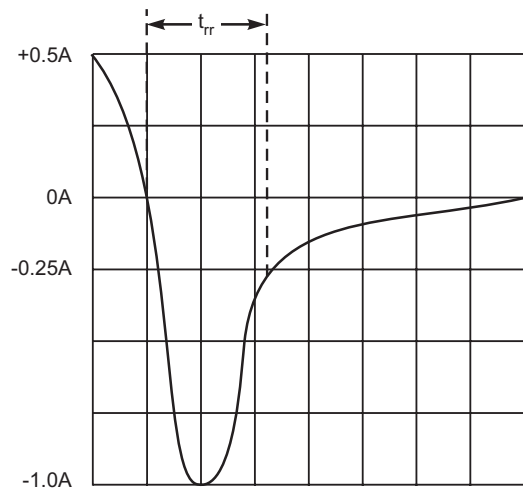

Fig. 4 Typical Junction Capacitance



- Notes:
1. Rise Time = 7.0ns max. Input Impedance = 1.0MΩ, 22pF.
 2. Rise Time = 10ns max. Input Impedance = 50Ω.



Set time base for 5/10ns/cm

Fig. 5 Reverse Recovery Time Characteristic and Test Circuit

ORDERING INFORMATION

Product No.♦	Package Type	Shipping Quantity
ED502YS-T3	DPAK	2500/Tape & Reel
ED503YS-T3	DPAK	2500/Tape & Reel
ED504YS-T3	DPAK	2500/Tape & Reel
ED506YS-T3	DPAK	2500/Tape & Reel

♦T3 suffix refers to a 13" reel.

Shipping quantity given is for minimum packing quantity only. For minimum order quantity, please consult the Sales Department.

RECOMMENDED FOOTPRINT

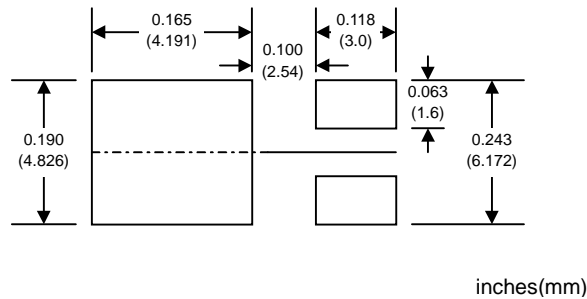

Won-Top Electronics Co., Ltd (WTE) has checked all information carefully and believes it to be correct and accurate. However, WTE cannot assume any responsibility for inaccuracies. Furthermore, this information does not give the purchaser of semiconductor devices any license under patent rights to manufacturer. WTE reserves the right to change any or all information herein without further notice.

WARNING: DO NOT USE IN LIFE SUPPORT EQUIPMENT. WTE power semiconductor products are not authorized for use as critical components in life support devices or systems without the express written approval.

Won-Top Electronics Co., Ltd.

No. 44 Yu Kang North 3rd Road, Chine Chen Dist., Kaohsiung, Taiwan

Phone: 886-7-822-5408 or 886-7-822-5410

Fax: 886-7-822-5417

Email: sales@wontop.com

Internet: <http://www.wontop.com>

We power your everyday.