

Features

- Glass passivated device
- Ideally Suited for Automatic Assembly
- Low Forward Voltage Drop, High Efficiency
- Surge Overload Rating to 2.5 A Peak
- Low Power Loss
- Ultra-Fast Recovery Time
- Plastic Case Material has UL Flammability
- Classification Rating 94V-0

Mechanical Data

- Case: SOD-123FL, Molded Plastic
- Terminals: Solder Plated, Solderable per MIL-STD-750, Method 2026
- Polarity: Cathode Band or Cathode Notch
- Marking: Type Number
- Weight: 0.01 grams (approx.)
- **Lead Free: For RoHS / Lead Free Version**

SOD - 123FL

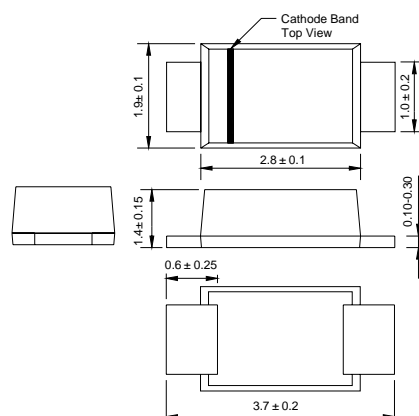

Dimensions in millimeters

Maximum Ratings and Electrical Characteristics @ $T_A=25^\circ\text{C}$ unless otherwise specified

Characteristic	Symbol	DSR 0.3A	DSR 0.3B	DSR 0.3D	DSR 0.3G	DSR 0.3J	DSR 0.3K	DSR 0.3M	UNITS
Peak Repetitive Reverse Voltage	V_{RRM}								V
Working Peak Reverse Voltage	V_{RWM}	50	100	200	400	600	800	1000	V
DC Blocking Voltage	V_R								V
RMS Reverse Voltage	$V_{R(RMS)}$	35	70	140	280	420	560	800	V
Average Rectified Output Current @ $T_L = 100^\circ\text{C}$	I_O	1.0							A
Non-Repetitive Peak Forward Surge Current 8.3ms Single half sine-wave superimposed on rated load (JEDEC Method)	I_{FSM}	25							A
Forward Voltage @ $I_F = 1.0\text{A}$	V_{FM}	1.3							V
Peak Reverse Current @ $T_A = 25^\circ\text{C}$ At Rated DC Blocking Voltage @ $T_A = 100^\circ\text{C}$	I_{RM}	10 500							μA
Typical Junction Capacitance (Note 2)	C_j	15							pF
Typical Thermal Resistance (Note 3)	$R_{\theta JL}$	30							$^\circ\text{C/W}$
Operating and Storage Temperature Range	T_j, T_{STG}	-65 to +150							$^\circ\text{C}$

- Note: 1. Measured with $I_F = 0.5\text{A}$, $I_R = 1.0\text{A}$, $I_{rr} = 0.25\text{A}$. See figure 5.
 2. Measured at 1.0 MHz and applied reverse voltage of 4.0 V DC.
 3. Mounted on P.C. Board with 8.0mm² land area.

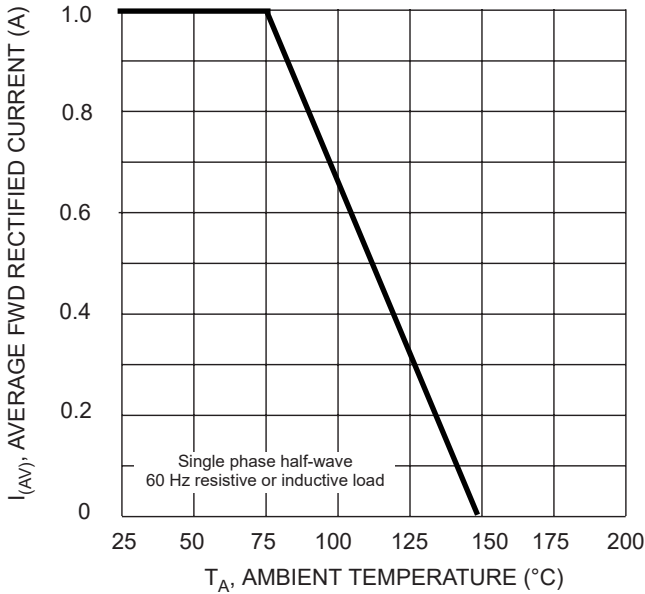

Fig. 1 Forward Derating Curve

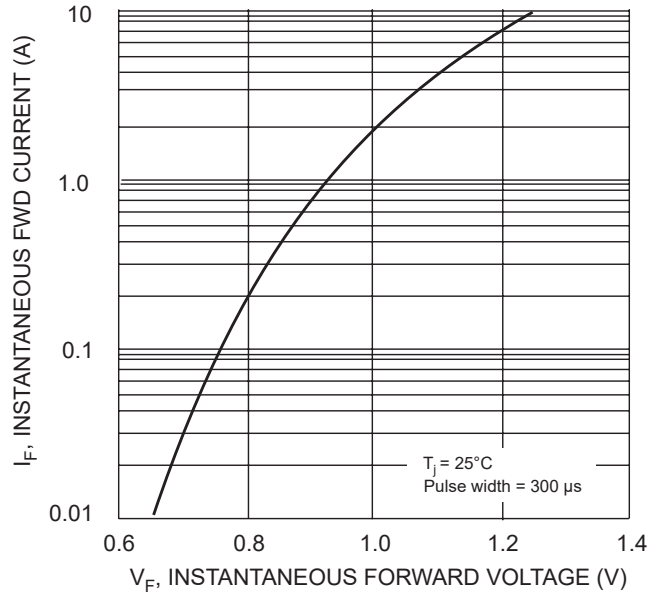

Fig. 2 Typical Forward Characteristics

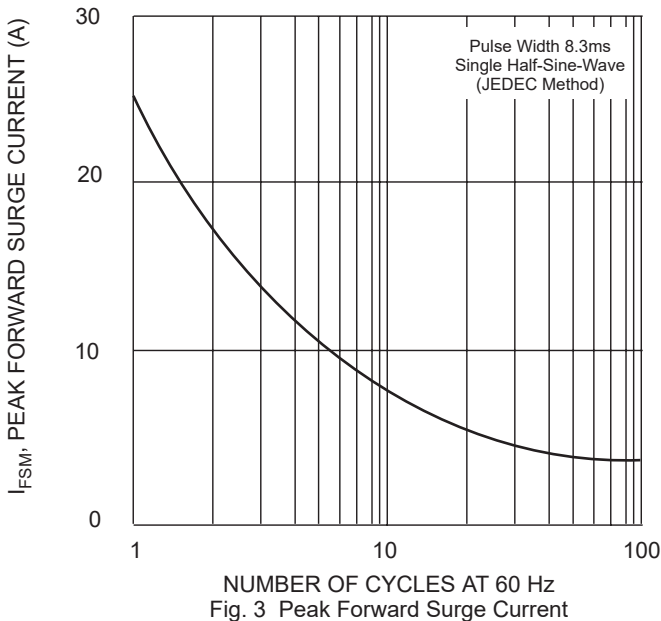

Fig. 3 Peak Forward Surge Current

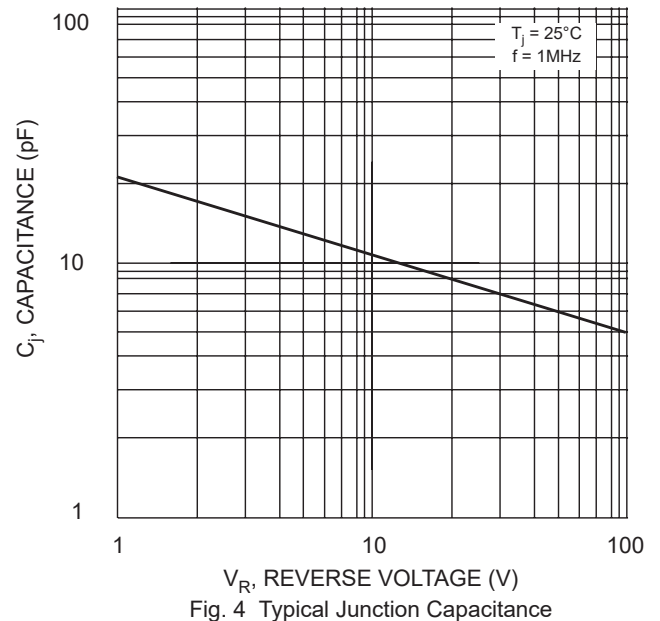
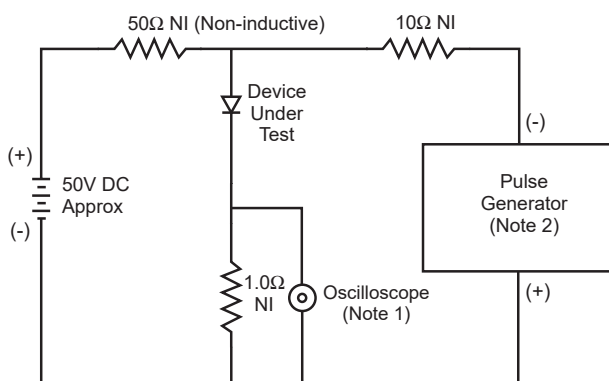
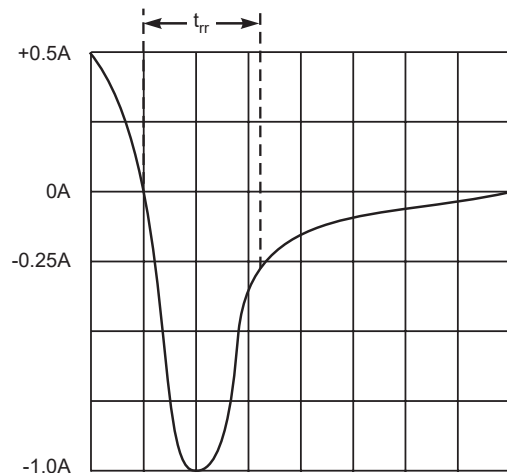

Fig. 4 Typical Junction Capacitance



- Notes:
1. Rise Time = 7.0ns max. Input Impedance = 1.0MΩ, 22pF.
 2. Rise Time = 10ns max. Input Impedance = 50Ω.



Set time base for 5/10ns/cm

Fig. 5 Reverse Recovery Time Characteristic and Test Circuit