

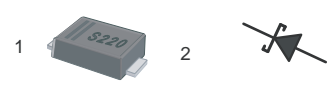
**Surface Mount Schottky Barrier Rectifier**  
**Reverse Voltage - 20 to 200 V Forward Current - 2.0A**

**Features**

- Metal silicon junction, majority carrier conduction
- For surface mounted applications
- Low power loss, high efficiency
- High forward surge current capability
- For use in low voltage, high frequency inverters, free wheeling, and polarity protection applications

**PINNING**

PIN	DESCRIPTION
1	Cathode
2	Anode



Top View  
Marking Code: DS22W ---S22  
DS24W ---S24  
DS26W ---S26  
DS28W ---S28  
DS210W ---S210  
DS212W ---S212  
DS215W ---S215  
DS220W ---S220

Weight: 17mg, 0.0006 oz  
Simplified outline SOD-123FH and symbol

**Absolute Maximum Ratings and Electrical characteristics**

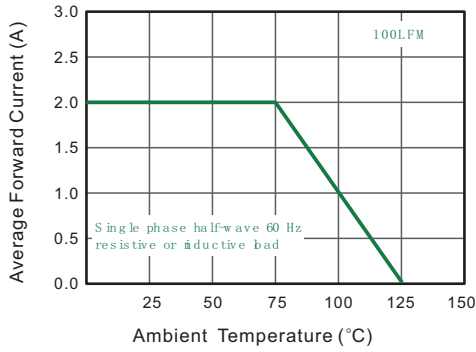
Ratings at 25 °C ambient temperature unless otherwise specified. Single phase, half wave, 60Hz resistive or inductive load, for capacitive load, derate by 20 %

Parameter	Symbols	DS22W	DS24W	DS26W	DS28W	DS210W	DS212W	DS215W	DS220W	Units
Maximum Repetitive Peak Reverse Voltage	$V_{RRM}$	20	40	60	80	100	120	150	200	V
Maximum RMS voltage	$V_{RMS}$	14	28	42	56	70	84	105	140	V
Maximum DC Blocking Voltage	$V_{DC}$	20	40	60	80	100	120	150	200	V
Maximum Average Forward Rectified Current	$I_{F(AV)}$	2.0								A
Peak Forward Surge Current, 8.3ms Single Half Sine-wave Superimposed on Rated Load (JEDEC method)	$I_{FSM}$	50				40				A
Max Instantaneous Forward Voltage at 2 A	$V_F$	0.55		0.70		0.85		0.95		V
Maximum DC Reverse Current $T_a = 25^\circ\text{C}$ at Rated DC Reverse Voltage $T_a = 100^\circ\text{C}$	$I_R$	0.5 10			0.3 5					mA
Typical Current Squared Time	$i^2t$	10.37								A <sup>2</sup> S
Typical Junction Capacitance <sup>1)</sup>	$C_j$	220			80					pF
Operating Junction Temperature Range	$T_j$	-55 ~ +125								°C
Storage Temperature Range	$T_{stg}$	-55 ~ +150								°C

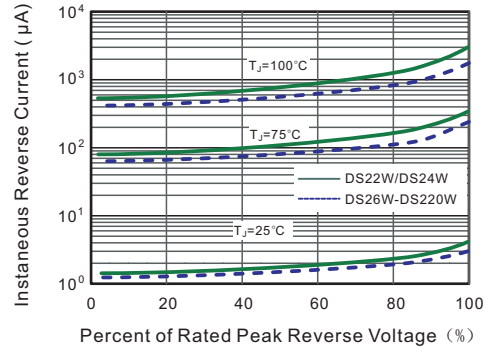
1) Measured at 1MHz and applied reverse voltage of 4 V D.C.

# RATING AND CHARACTERISTICS CURVES (DS22W THRU DS220W)

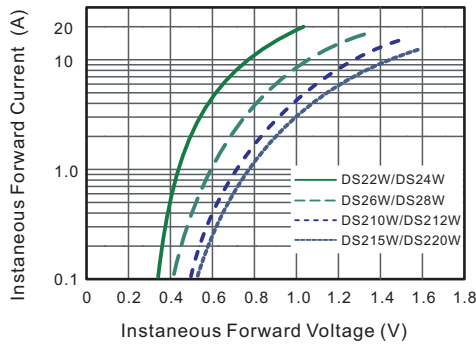
**Fig.1 Forward Current Derating Curve**



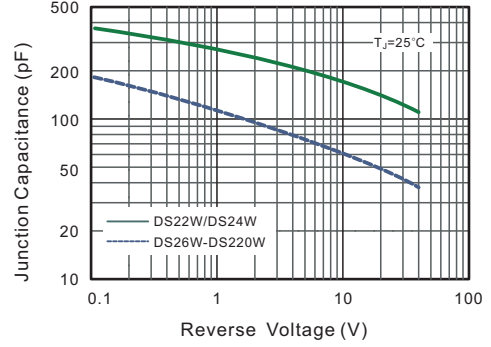
**Fig.2 Typical Reverse Characteristics**



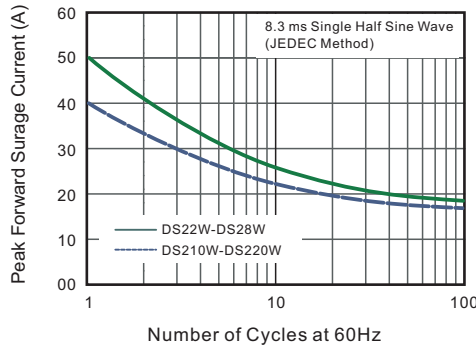
**Fig.3 Typical Forward Characteristic**



**Fig.4 Typical Junction Capacitance**

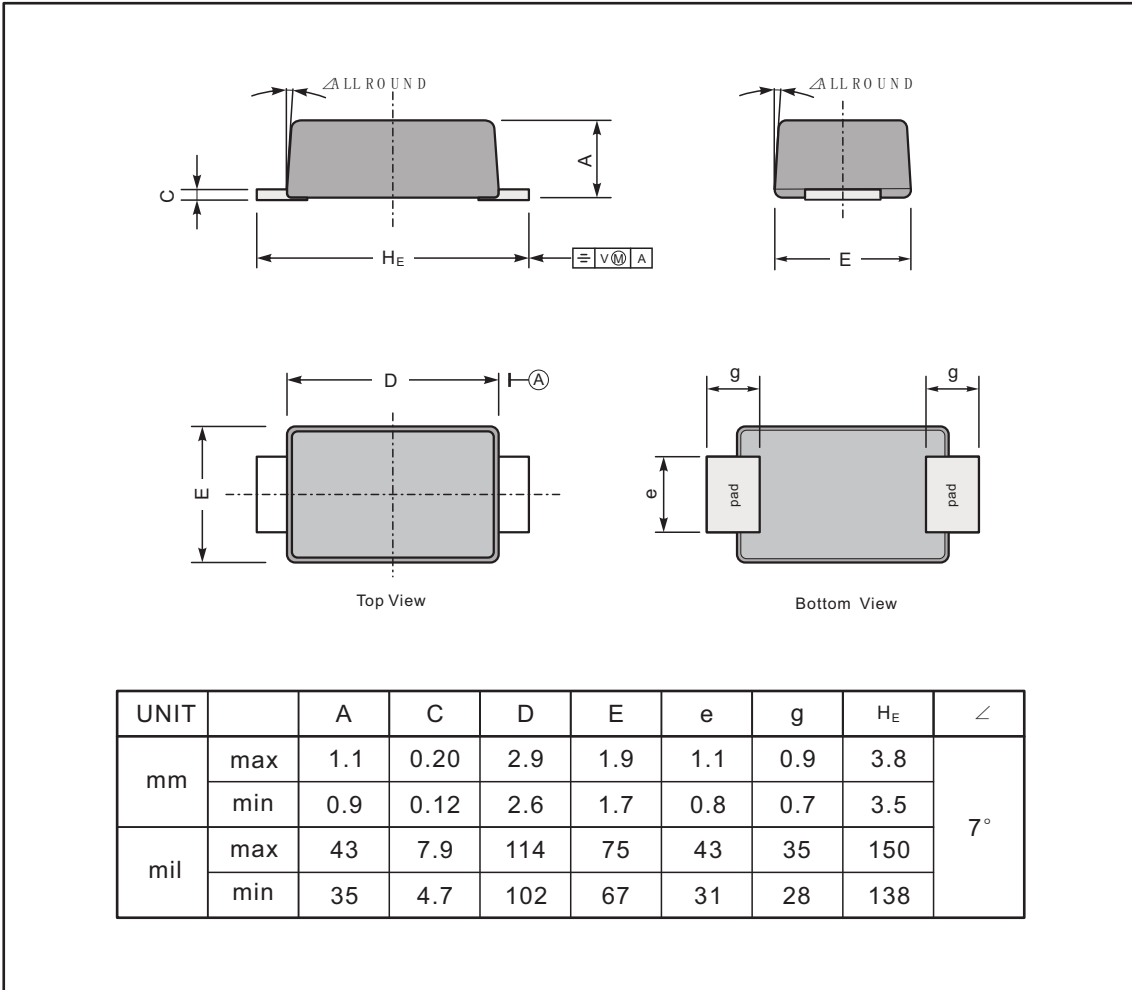


**Fig.5 Maximum Non-Repetitive Peak Forward Surge Current**

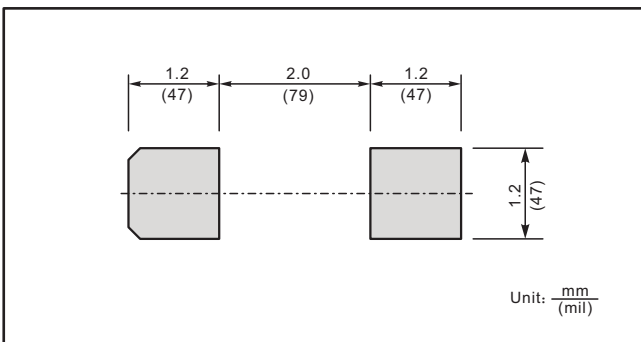


# PACKAGE OUTLINE

## Plastic surface mounted package; 2 leads



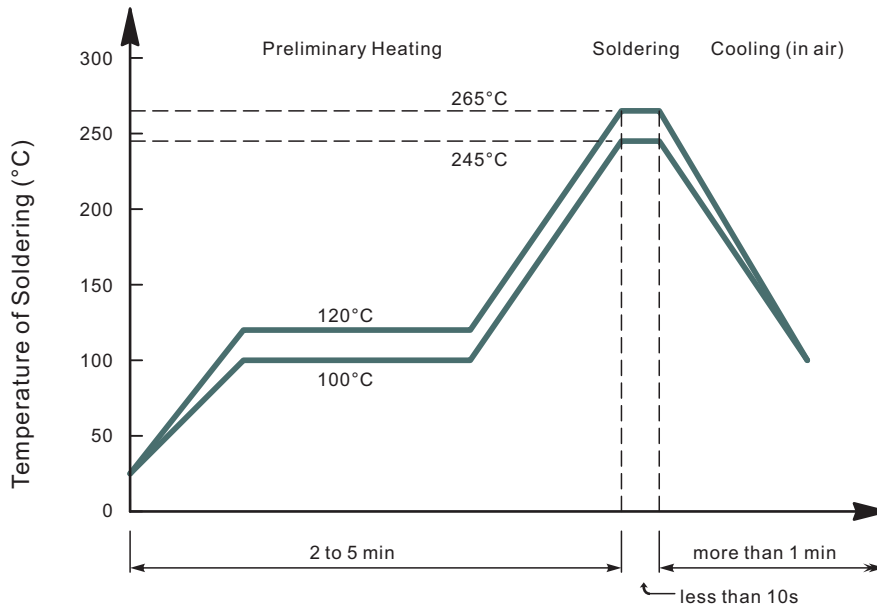
### The recommended mounting pad size



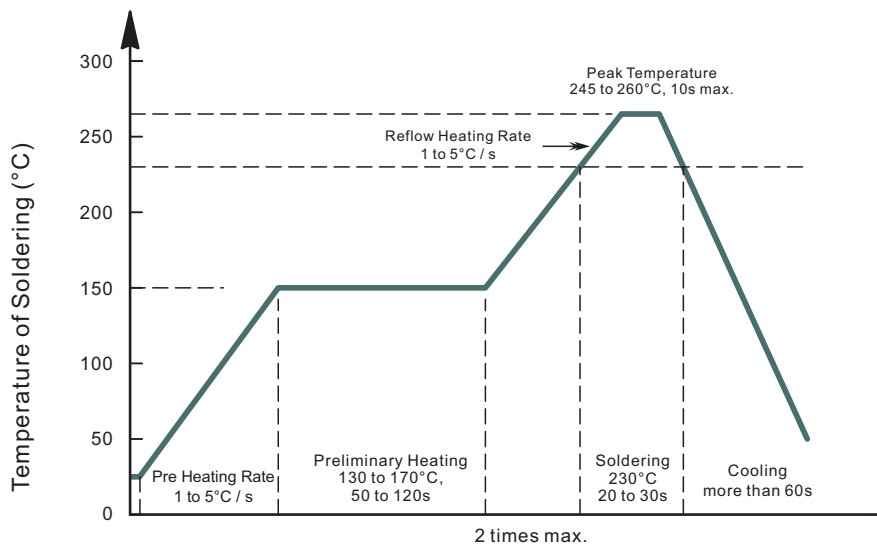
### Marking

Type number	Marking code
DS22W	S22
DS24W	S24
DS26W	S26
DS28W	S28
DS210W	S210
DS212W	S212
DS215W	S215
DS220W	S220

• Recommended condition of flow soldering



• Recommended condition of reflow soldering



Recommended peak temperature is over 245 °C. If peak temperature is below 245 °C, you may adjust the following parameters; time length of peak temperature (longer), time length of soldering (longer), thickness of solder paste (thicker)

• Condition of hand soldering

Temperature: 350°C  
 Time: 3s max.  
 Times: one time

• Remark:

Lead free solder paste (96.5Sn/3.0Ag/0.5Cu)

## PACKAGING OF DIODE AND BRIDGE RECTIFIERS

### REEL PACK

PACKAGE	PACKING CODE	EA PER REEL	EA PER INNER BOX	COMPONENT SPACE (mm)	TAPE SPACE (mm)	REEL DIA (mm)	CARTON SIZE (mm)	EA PER CARTON	GROSS WEIGHT(Kg)
SOD-123FH	-W/T	3,000	15,000	---	---	178	390*205*31	120,000	6.964

## DISCLAIMER NOTICE

Rectron Inc reserves the right to make changes without notice to any product specification herein, to make corrections, modifications, enhancements or other changes. Rectron Inc or anyone on its behalf assumes no responsibility or liability for any errors or inaccuracies. Data sheet specifications and its information contained are intended to provide a product description only. "Typical" parameters which may be included on RECTRON data sheets and/ or specifications can and do vary in different applications and actual performance may vary over time. Rectron Inc does not assume any liability arising out of the application or use of any product or circuit.

Rectron products are not designed, intended or authorized for use in medical, life-saving implant or other applications intended for life-sustaining or other related applications where a failure or malfunction of component or circuitry may directly or indirectly cause injury or threaten a life without expressed written approval of Rectron Inc. Customers using or selling Rectron components for use in such applications do so at their own risk and shall agree to fully indemnify Rectron Inc and its subsidiaries harmless against all claims, damages and expenditures.