



240W Single Output Industrial DIN RAIL Power Supply

DRP-240 series



■ Features :

- Universal AC input / Full range
- Built in active PFC function
- Protections: Short circuit / Overload / Over voltage / Over temperature
- Cooling by free air convection
- Can be installed on DIN rail TS-35/7.5 or 15
- UL 508(industrial control equipment)approved
- LED indicator for power on
- 100% full load burn-in test
- Fixed switching frequency at 100KHz
- 3 years warranty



SPECIFICATION

MODEL	DRP-240-24	DRP-240-48	
OUTPUT	DC VOLTAGE	24V	48V
	RATED CURRENT	10A	5A
	CURRENT RANGE	0 ~ 10A	0 ~ 5A
	RATED POWER	240W	240W
	RIPPLE & NOISE (max.) Note.2	80mVp-p	150mVp-p
	VOLTAGE ADJ. RANGE	24 ~ 28V	48 ~ 53V
	VOLTAGE TOLERANCE Note.3	±1.0%	±1.0%
	LINE REGULATION	±0.5%	±0.5%
	LOAD REGULATION	±1.0%	±1.0%
	SETUP, RISE TIME	800ms, 40ms/230VAC	800ms, 40ms/115VAC at full load
HOLD UP TIME (Typ.)	24ms/230VAC	24ms/115VAC at full load	
INPUT	VOLTAGE RANGE Note.5	85 ~ 264VAC	120 ~ 370VDC
	FREQUENCY RANGE	47 ~ 63Hz	
	POWER FACTOR (Typ.)	0.96/230VAC	0.99/115VAC at full load
	EFFICIENCY (Typ.)	84%	85%
	AC CURRENT (Typ.)	2.8A/115VAC	1.4A/230VAC
	INRUSH CURRENT (Typ.)	COLD START 27A/115VAC	45A/230VAC
	LEAKAGE CURRENT	<3.5mA / 240VAC	
PROTECTION	OVERLOAD	105 ~ 150% rated output power	Protection type : Constant current limiting, recovers automatically after fault condition is removed
	OVER VOLTAGE	30 ~ 36V	54 ~ 60V
	OVER TEMPERATURE	100°C ±5°C (TSW1)detect on heat sink of power transistor	Protection type : Shut down o/p voltage, recovers automatically after temperature goes down
ENVIRONMENT	WORKING TEMP.	-10 ~ +70°C (Refer to output load derating curve)	
	WORKING HUMIDITY	20 ~ 90% RH non-condensing	
	STORAGE TEMP., HUMIDITY	-20 ~ +85°C, 10 ~ 95% RH	
	TEMP. COEFFICIENT	±0.03%/°C (0 ~ 50°C)	
	VIBRATION	10 ~ 500Hz, 2G 10min./1cycle, 60min. each along X, Y, Z axes; Mounting: Compliance to IEC60068-2-6	
SAFETY & EMC (Note 4)	SAFETY STANDARDS	UL508, UL60950-1, TUV EN60950-1 approved	
	WITHSTAND VOLTAGE	I/P-O/P:3KVAC I/P-FG:1.5KVAC O/P-FG:0.5KVAC	
	ISOLATION RESISTANCE	I/P-O/P, I/P-FG, O/P-FG:100M Ohms/500VDC	
	EMI CONDUCTION & RADIATION	Compliance to EN55011,EN55022 (CISPR22) Class B	
	HARMONIC CURRENT	Compliance to EN61000-3-2,-3	
	EMS IMMUNITY	Compliance to EN61000-4-2,3,4,5,6,8,11, ENV50204, EN55024, EN61000-6-2 (EN50082-2), heavy industry level, criteria A	
OTHERS	MTBF	105.5Khrs min. MIL-HDBK-217F (25°C)	
	DIMENSION	125.5*125.2*100mm (W*H*D)	
	PACKING	1.2Kg; 12pcs/15.5Kg/1.29CUFT	
NOTE	<ol style="list-style-type: none"> 1. All parameters NOT specially mentioned are measured at 230VAC input, rated load and 25°C of ambient temperature. 2. Ripple & noise are measured at 20MHz of bandwidth by using a 12" twisted pair-wire terminated with a 0.1uf & 47uf parallel capacitor. 3. Tolerance : includes set up tolerance, line regulation and load regulation. 4. The power supply is considered a component which will be installed into a final equipment. The final equipment must be re-confirmed that it still meets EMC directives. 5. Derating may be needed under low input voltages. Please check the derating curve for more details. 		

Mechanical Specification

Case No. 922A Unit:mm

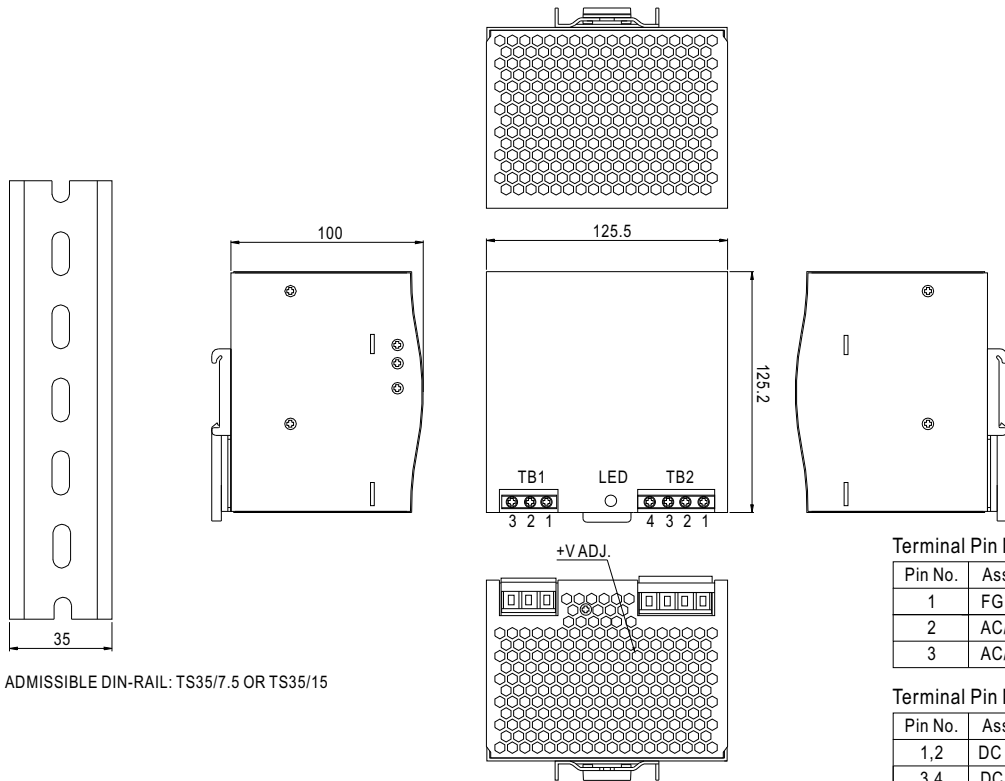

ADMISSIBLE DIN-RAIL: TS35/7.5 OR TS35/15

Terminal Pin Number Assignment (TB1)

Pin No.	Assignment
1	FG ⊕
2	AC/N
3	AC/L

Terminal Pin Number Assignment (TB2)

Pin No.	Assignment
1,2	DC OUTPUT +V
3,4	DC OUTPUT -V

Block Diagram

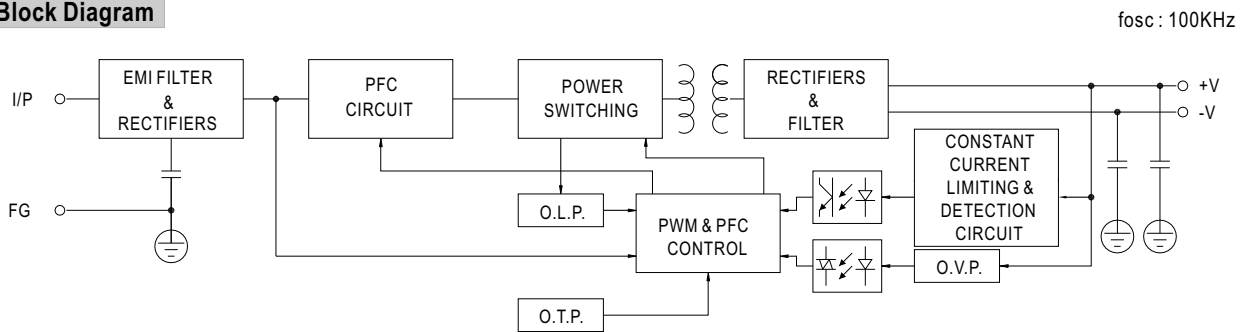

Derating Curve

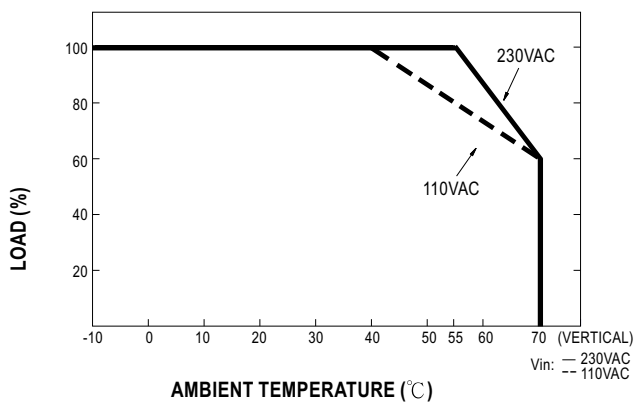

Output derating VS input voltage

