

DF30JC6

60V 30A

OUTLINE DIMENSIONS

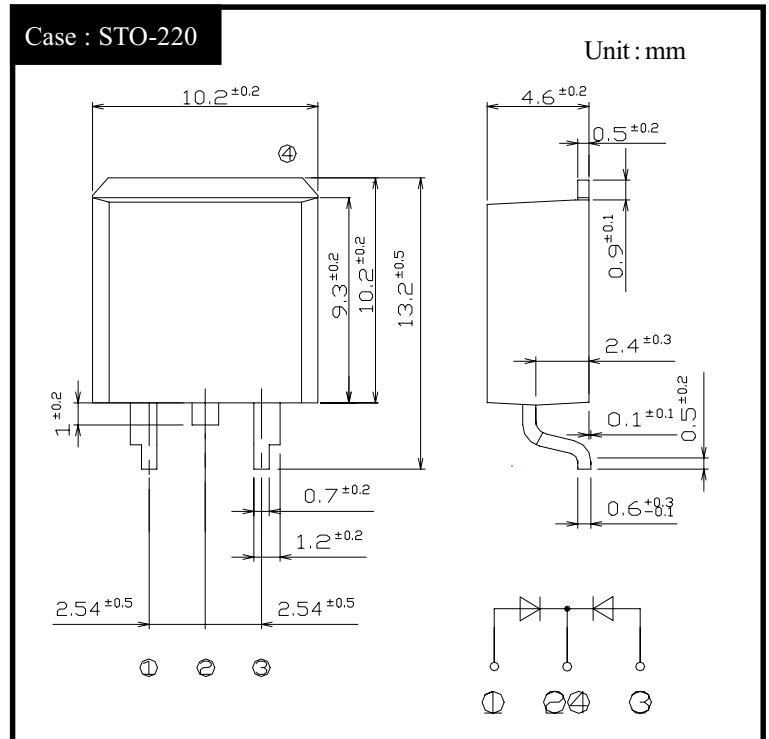

RATINGS

● Absolute Maximum Ratings (Unless otherwise specified, $T_c=25^\circ\text{C}$)

Item	Symbol	Conditions	Ratings	Unit
Storage Temperature	T_{stg}		-55~150	$^\circ\text{C}$
Operating Junction Temperature	T_j		150	$^\circ\text{C}$
Maximum Reverse Voltage	V_{RM}		60	V
Repetitive Peak Surge Reverse Voltage	V_{RRSM}	Pulse width 0.5ms, duty 1/40	65	V
Average Rectified Forward Current	I_O	50Hz sine wave, R-load, Rating for each diode $I_O/2$, $T_c=108^\circ\text{C}$	30	A
Peak Surge Forward Current	I_{FSM}	50Hz sine wave, Non-repetitive 1 cycle peak value, $T_j=25^\circ\text{C}$	250	A

● Electrical Characteristics (Unless otherwise specified, $T_c=25^\circ\text{C}$)

Item	Symbol	Conditions	Ratings	Unit
Forward Voltage	V_F	$I_F=15\text{A}$, Pulse measurement, Rating of per diode	Max 0.69	V
Reverse Current	I_R	$V_R=V_{RM}$, Pulse measurement, Rating of per diode	Max 0.7	mA
Junction Capacitance	C_j	$f=1\text{MHz}$, $V_R=10\text{V}$, Rating of per diode	Typ 490	pF
Thermal Resistance	θ_{jc}	junction to case	Max 1.6	$^\circ\text{C}/\text{W}$

DF30JC6 Forward Voltage

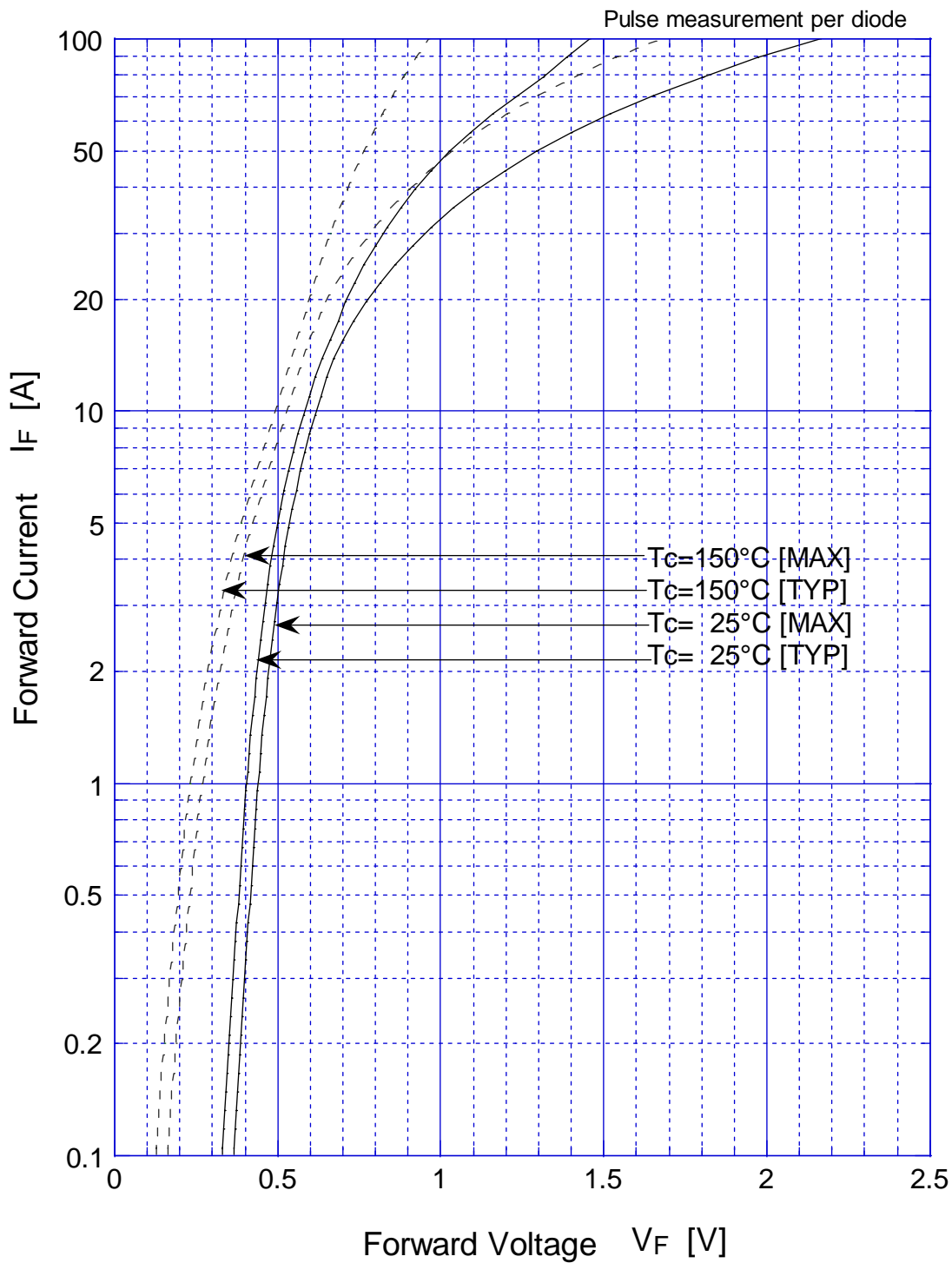

DF30JC6 Reverse Current

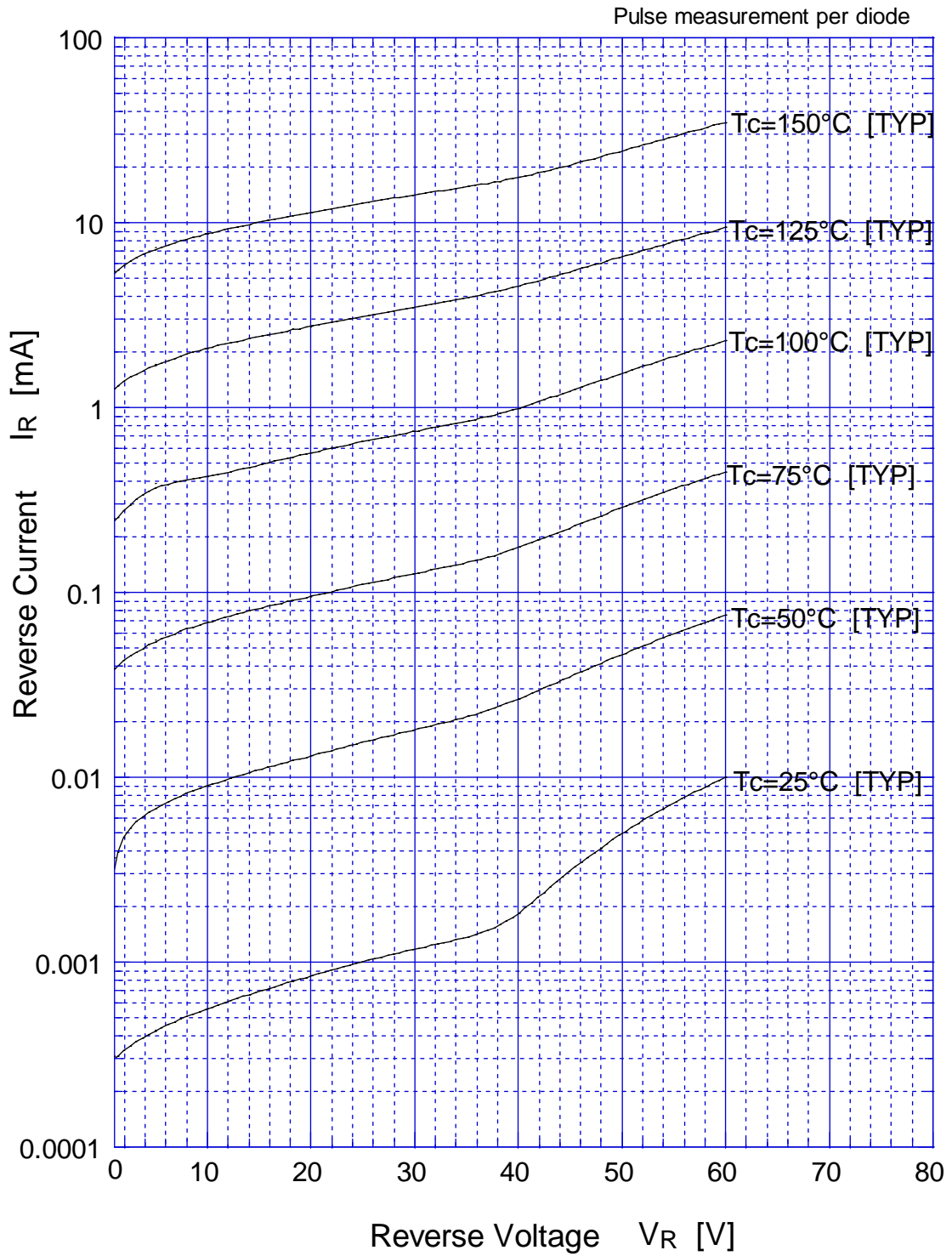

DF30JC6

Forward Power Dissipation

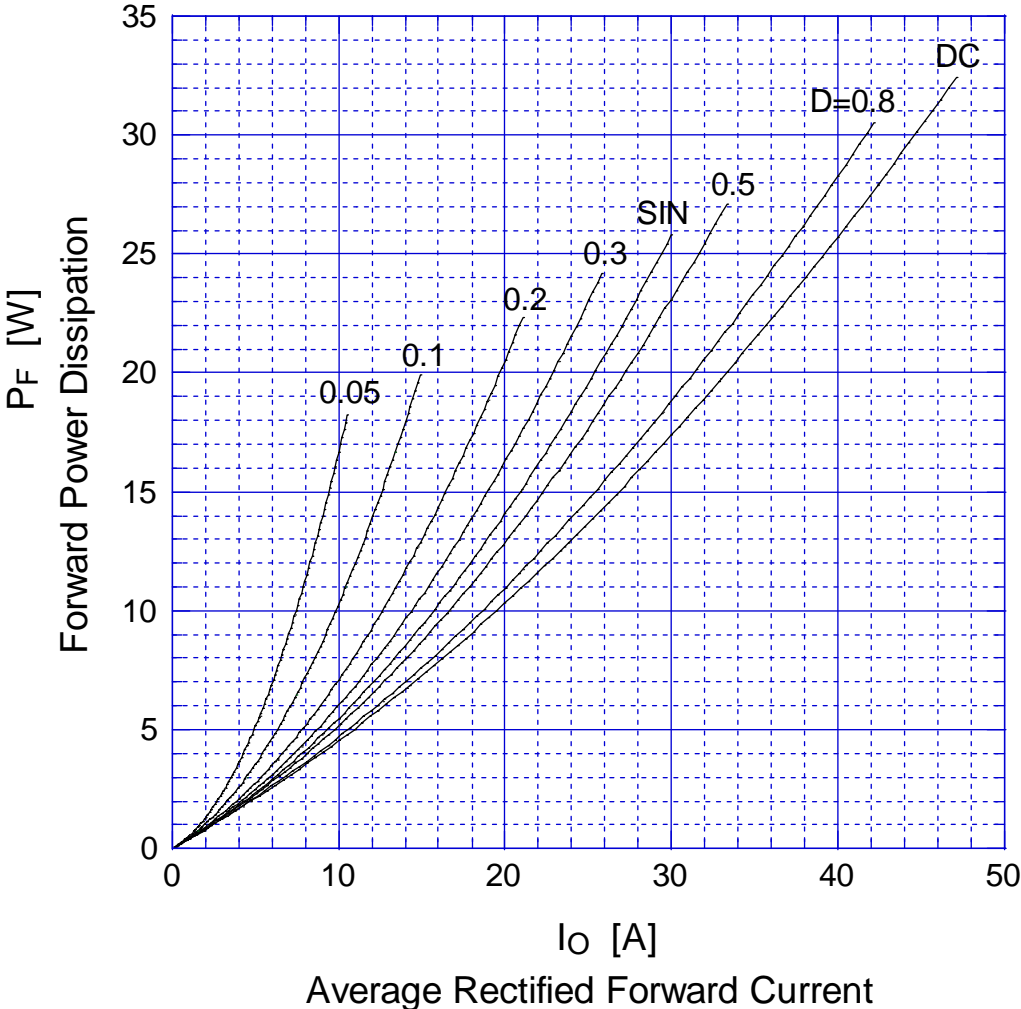

Tj = 150°C

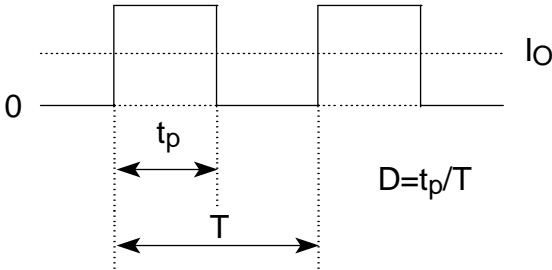

DF30JC6

Reverse Power Dissipation

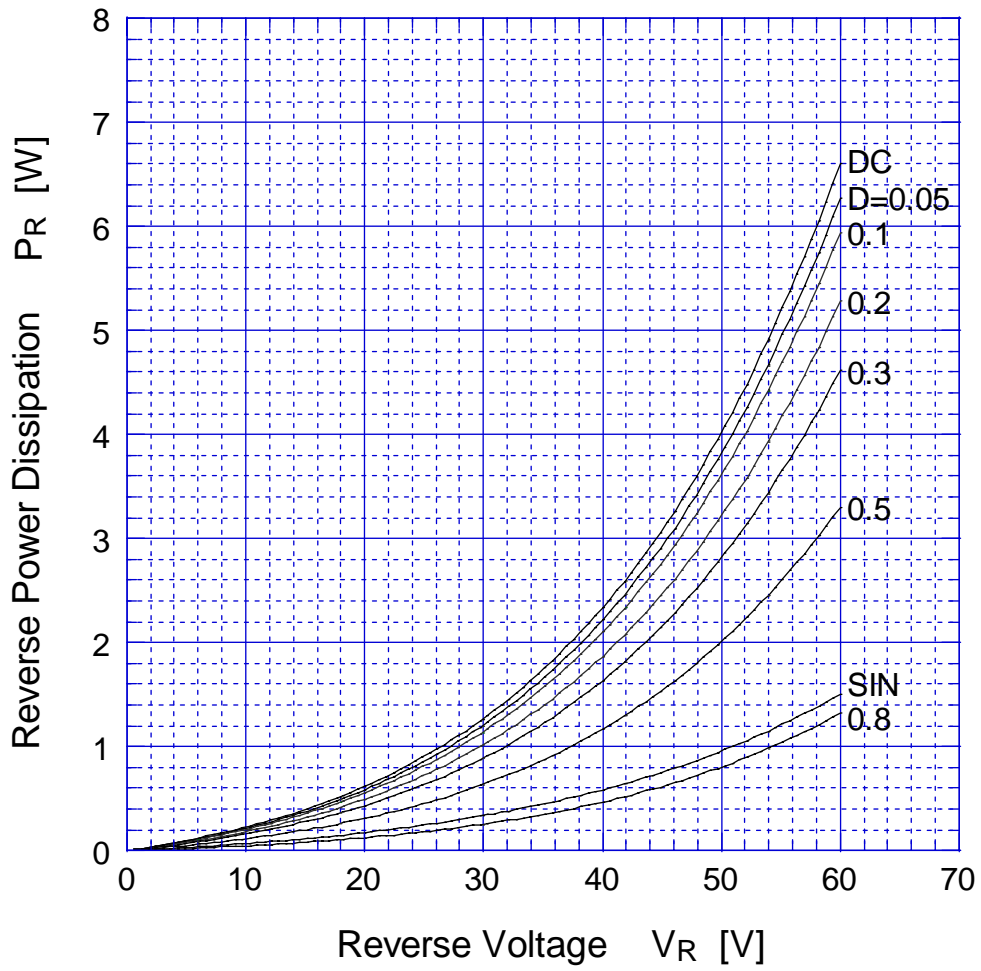

$T_j = 150^\circ\text{C}$

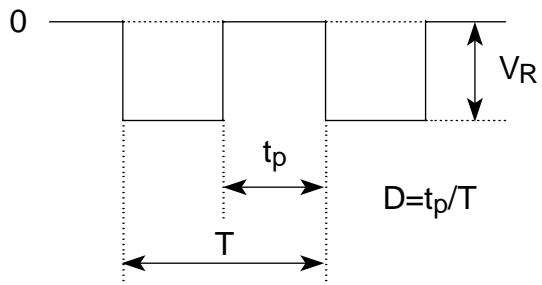

DF30JC6

Derating Curve

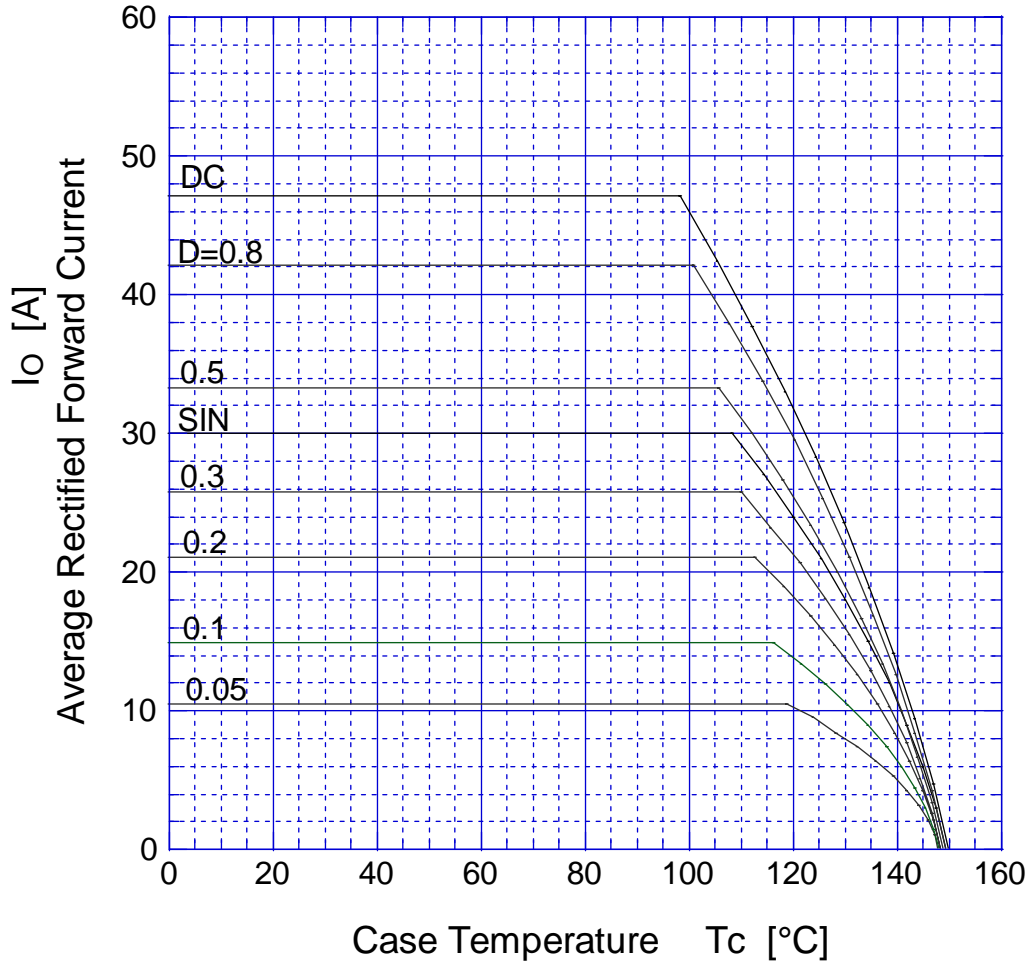

$V_R = 30V$

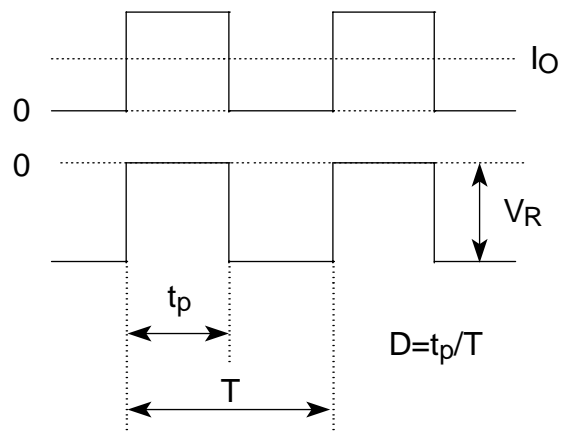

DF30JC6 Peak Surge Forward Capability

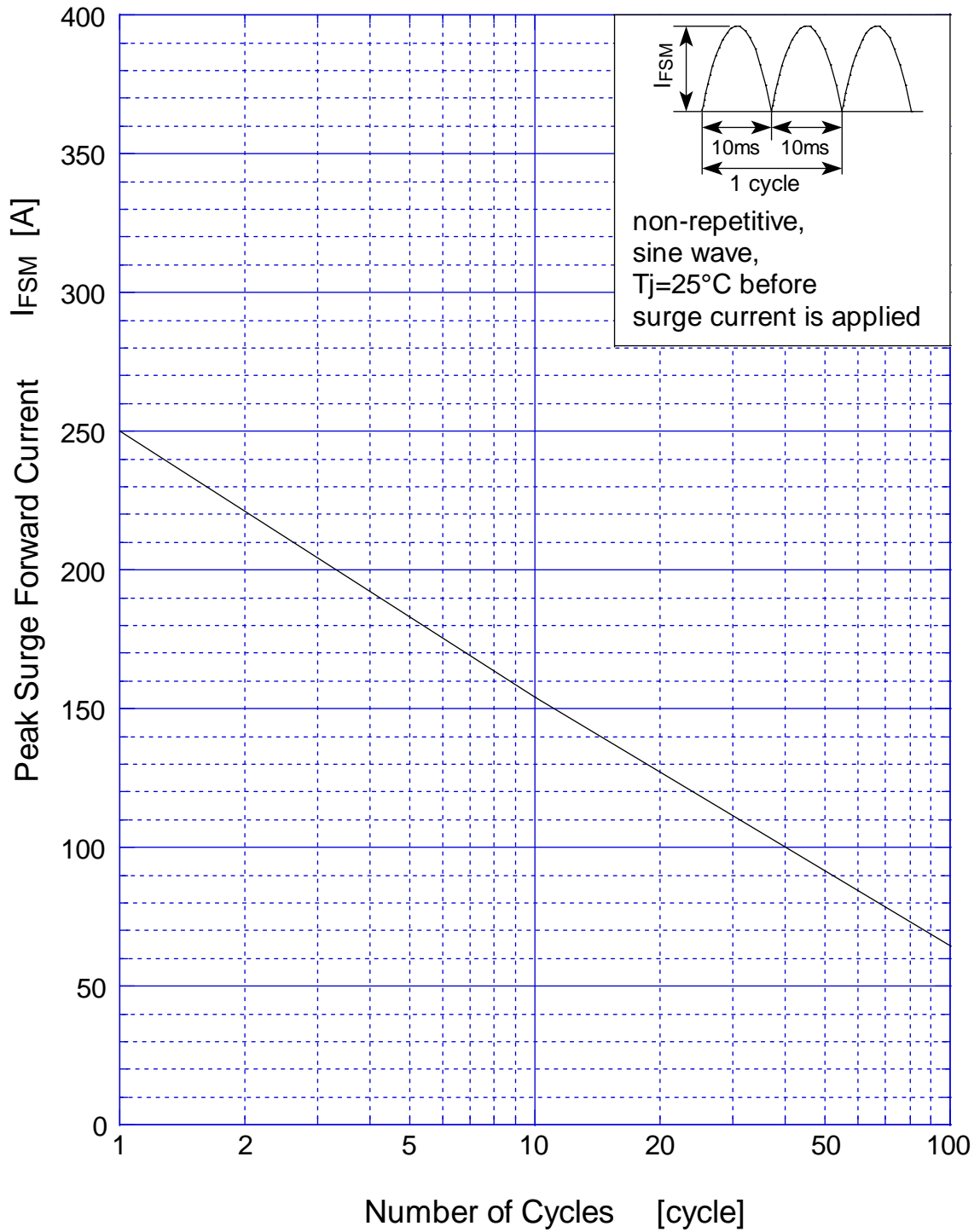

DF30JC6 Junction Capacitance

