

Standard Recovery Diodes (Hockey PUK Version), 2500A

FEATURES

- Wide current range
- High voltage ratings up to 2500V
- High surge current capabilities
- Diffused junction
- Hockey PUK version
- Case style DO-220AC(K-PUK), Nell's D-type Capsule
- Lead (Pb)-free

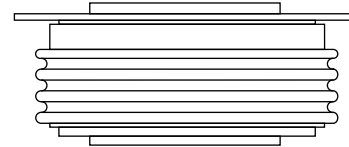

DO-220AC(K-PUK)
(Nell's D-type Capsule)

TYPICAL APPLICATIONS

- Converters
- Power supplies
- Machine tool controls
- High power drives
- Medium traction applications

PRODUCT SUMMARY	
$I_{F(AV)}$	2500A

MAJOR RATINGS AND CHARACTERISTICS			
PARAMETER	TEST CONDITIONS	VALUES	UNIT
$I_{F(AV)}$		2500	A
	T_{hs}	55	°C
$I_{F(RMS)}$		4300	A
	T_{hs}	25	°C
I_{FSM}	50 HZ	26000	A
	60 HZ	27200	
I^2t	50 HZ	3380	kA ² s
	60 HZ	3070	
V_{RRM}		800 to 2500	V
T_J	Typical	-40 to 175	°C

ELECTRICAL SPECIFICATIONS

VOLTAGE RATINGS				
TYPE NUMBER	VOLTAGE CODE	V_{RRM} , MAXIMUM REPETITIVE PEAK REVERSE VOLTAGE V	V_{RSM} , MAXIMUM NON-REPETITIVE PEAK REVERSE VOLTAGE V	I_{RRM} , MAXIMUM AT $T_J = T_J$ MAXIMUM mA
D2500D	08	800	900	75
	12	1200	1300	
	16	1600	1700	
	20	2000	2100	
	25	2500	2600	

FORWARD CONDUCTION					
PARAMETER	SYMBOL	TEST CONDITIONS		VALUES	UNIT
Maximum average forward current at heatsink temperature	$I_{F(AV)}$	180° conduction, half sine wave Double side (single side) cooled		2500(1300)	A
				55(85)	°C
Maximum RMS forward current	$I_{F(RMS)}$	25°C heatsink temperature double side cooled		4300	A
Maximum peak, one cycle non-repetitive surge current	I_{FSM}	t = 10ms	No voltage reapplied	Sinusoidal half wave, initial $T_J = T_J$ maximum	A
		t = 8.3ms			
		t = 10ms	100% V_{RRM} reapplied		
		t = 8.3ms			
Maximum I^2t for fusing	I^2t	t = 10ms	No voltage reapplied	Sinusoidal half wave, initial $T_J = T_J$ maximum	kA ² s
		t = 8.3ms			
		t = 10ms	100% V_{RRM} reapplied		
		t = 8.3ms			
Maximum $I^2\sqrt{t}$ for fusing	$I^2\sqrt{t}$	t = 0.1 to 10 ms, no voltage reapplied		33800	kA ² √s
Low level value of threshold voltage	$V_{F(TO)1}$	$(16.7\% \times \pi \times I_{F(AV)} < I < \pi \times I_{F(AV)})$, $T_J = T_J$ maximum		0.83	V
High level value of threshold voltage	$V_{F(TO)2}$	$(I > \pi \times I_{F(AV)})$, $T_J = T_J$ maximum		1.00	
Low level value of forward slope resistance	r_{t1}	$(16.7\% \times \pi \times I_{F(AV)} < I < \pi \times I_{F(AV)})$, $T_J = T_J$ maximum		0.19	mΩ
High level value of forward slope resistance	r_{t2}	$(I > \pi \times I_{F(AV)})$, $T_J = T_J$ maximum		0.17	
Maximum forward voltage drop	V_{FM}	$I_{pk} = 4000A$, $T_J = T_J$ maximum, $t_p = 10$ ms sinusoidal wave		1.55	V

THERMAL AND MECHANICAL SPECIFICATIONS					
PARAMETER	SYMBOL	TEST CONDITIONS		VALUES	UNIT
Maximum junction operating temperature range	T_J			-40 to 175	°C
Maximum storage temperature range	T_{stg}			-55 to 200	
Maximum thermal resistance, junction to heatsink	R_{thJ-hs}	DC operation single side cooled		0.042	K/W
		DC operation double side cooled		0.020	
Mounting force, ±10%				22250 (2250)	N (kg)
Approximate weight				425	g
Case style		TO-200AC (K-PUK), Nell's D-type Capsule			

△ R_{thJc} CONDUCTION						
CONDUCTION ANGEL	SINUSOIDAL CONDUCTION		RECTANGULAR CONDUCTION		TEST CONDUCTIONS	UNITS
	SINGLE SIDE	DOUBLE SIDE	SINGLE SIDE	DOUBLE SIDE		
180°	0.002	0.002	0.001	0.001	$T_J = T_J$ maximum	K/W
120°	0.002	0.002	0.002	0.002		
90°	0.003	0.003	0.003	0.003		
60°	0.004	0.004	0.004	0.004		
30°	0.007	0.007	0.007	0.007		

Note

- The table above shows the increment of thermal resistance R_{thJ-hs} when devices operate at different conduction angles than DC

Fig.1 Current ratings characteristics

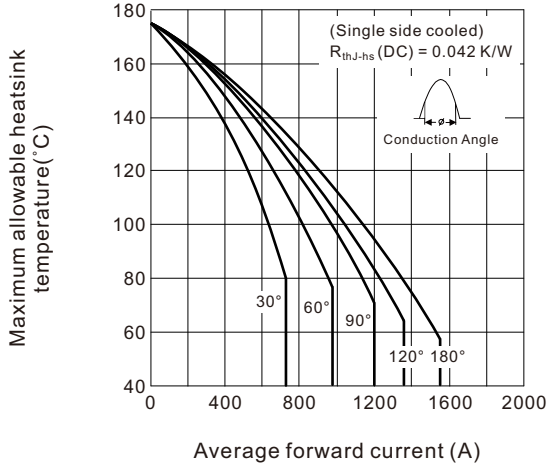

Fig.2 Current ratings characteristics

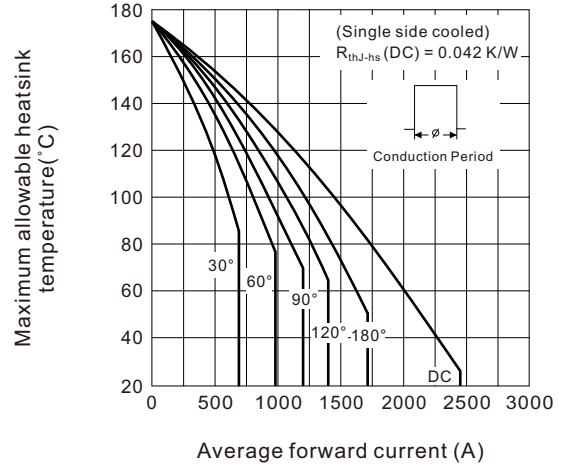

Fig.3 Current ratings characteristics

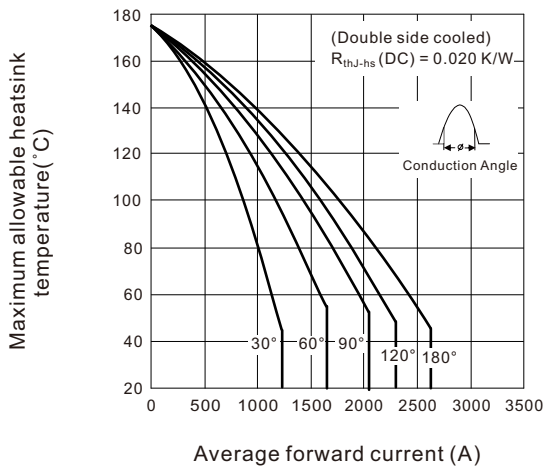

Fig.4 Current ratings characteristics

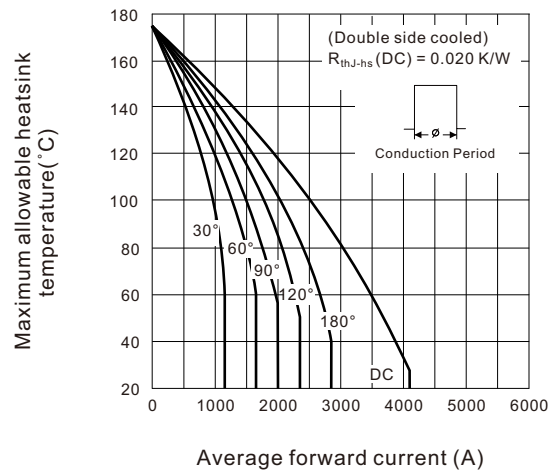

Fig.5 Forward power loss characteristics

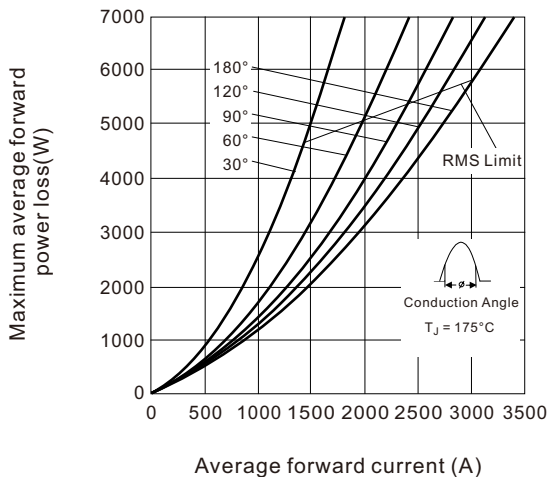

Fig.6 Forward power loss characteristics

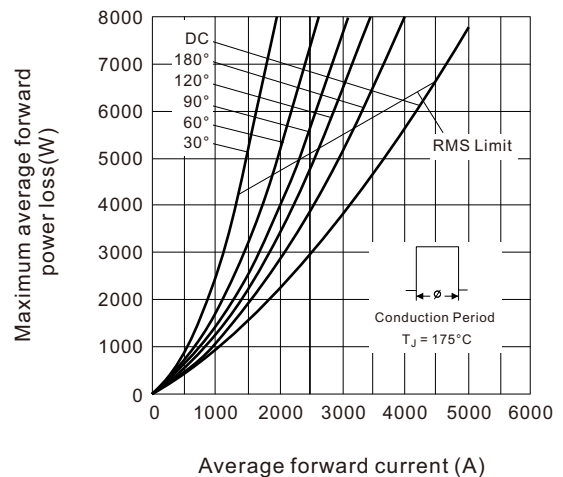

Fig.7 Maximum non-repetitive surge current single and double side cooled

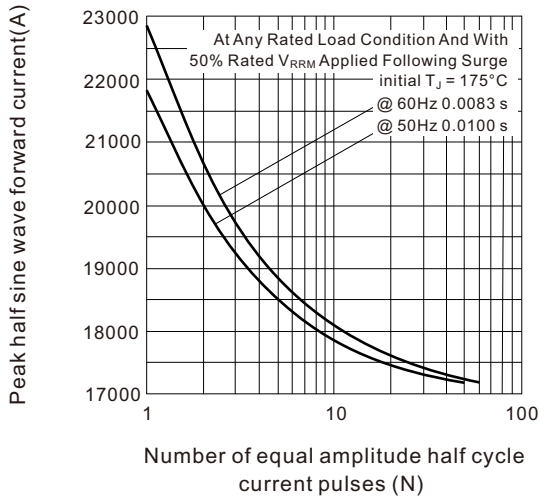

Fig.8 Maximum non-repetitive surge current single and double side cooled

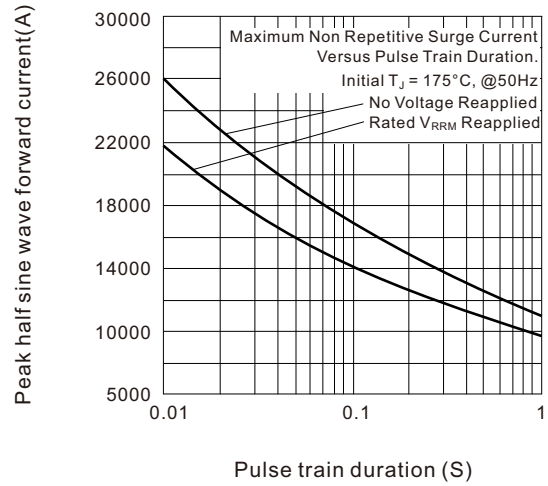

Fig.9 Forward voltage drop characteristics

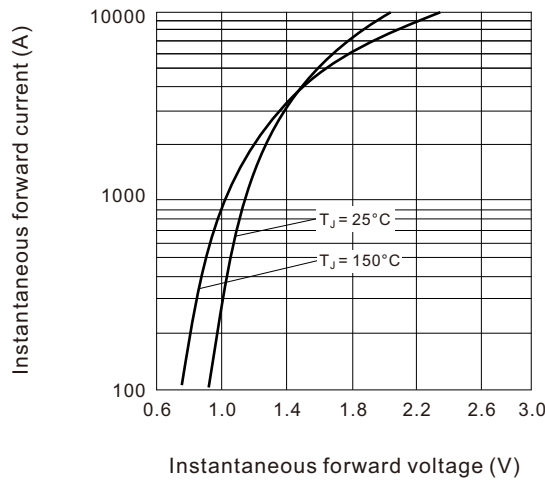
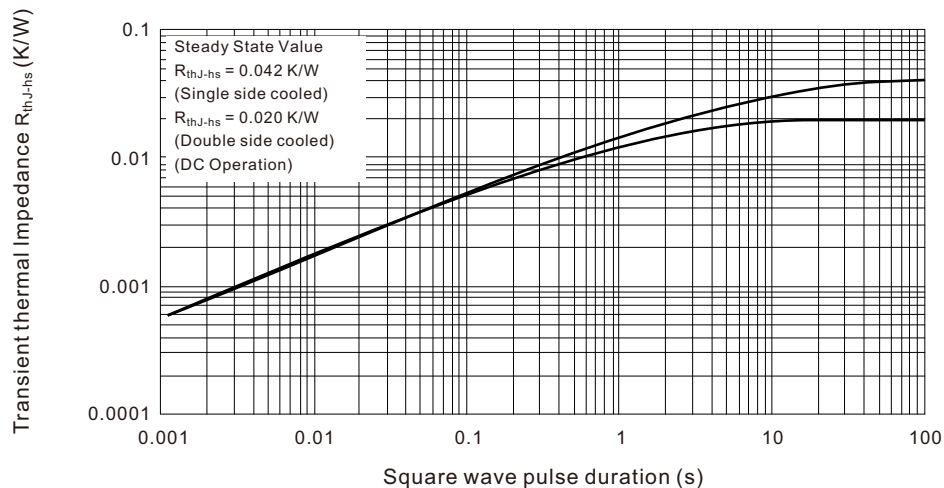
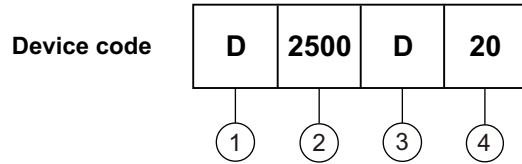

Fig.10 Thermal Impedance R_{thJ-hs} characteristics



ORDERING INFORMATION TABLE



- ① - "D" for standard recovery diode
- ② - Maximum average forward current, "2500" for 2500A
- ③ - Case style : "D" for Nell's D-type Capsule, DO-200AC (K-PUK)
- ④ - Voltage code, code x 100 = V_{RRM}

DO-220AC (K-PUK), Nell's D-type Capsule

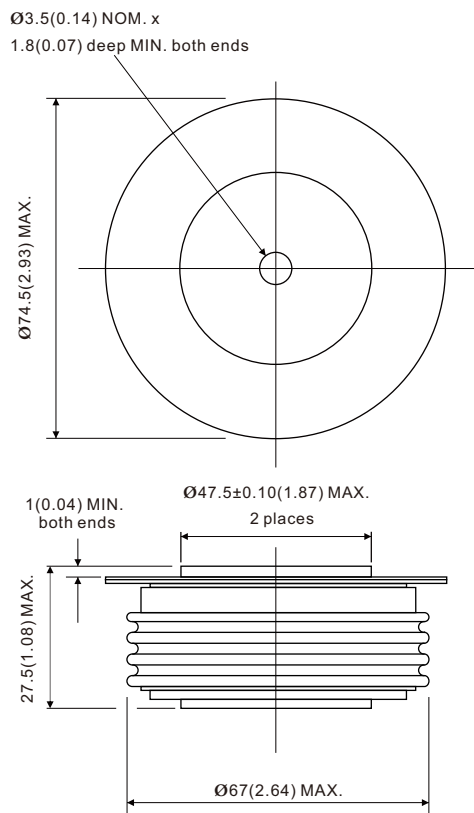

All dimensions in millimeters (inches)

