

CMOS 4-bit 1 Chip Microcomputer**Description**

The CXP50212/50216 features the following variety of functions. A 4-bit CPU, ROM, RAM, I/O port, 8-bit timer, 8-bit timer/counter, 18-bit time base timer, 8-bit serial I/O, vector interrupt and power on reset functions. This CMOS 4-bit microcomputer also integrates a fluorescent display panel controller/driver, PWM output port for D/A conversion, remote control receiving circuit, 3-bit A/D converter, 8-bit timer and a standby function for low power consumption operation, all in a single chip.

Features

- Instruction cycle 1.9 μ s/4.19MHz
- ROM capacity 16384 \times 8 bits (CXP50216)
12288 \times 8 bits (CXP50212)
- RAM capacity 544 \times 4 bits
(Including display area)
- 40 general purpose I/O ports
- 8 high current ports (Ports C, D)
- Fluorescent display panel controller/driver
(Able to display maximum 256 segments)
 - 1 to 16 digits dynamic scan display
(1 to 8 digits at 24 segments)
 - Page mode/variable mode
 - Dimmer function
 - High tension proof output (40 V)
 - Selection possible for incorporating pull-down
resistance (mask option)
- 14-bit PWM output for D/A conversion
- Remote control receiving circuit
- 3-bit A/D converter (1 channel per circuit)
- 8-bit/4-bit variable prescaler serial I/O
- 8-bit prescaler timer, 8-bit prescaler timer/event
counter, 18-bit time base timer and 8-bit reload
type timer with prescaler, independently controlled

64pin SDIP (Plastic)

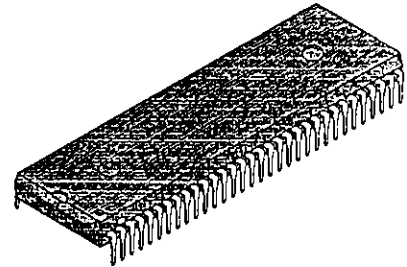

- Arithmetic and logical operations possible between the entire ROM area, I/O area and the accumulator by means of memory mapped I/O
- Reference to the entire ROM area is possible with the table look-up instruction
- 2 kinds of power down modes, sleep and stop
- Power on reset circuit (mask option)
- Provided with 64 pin plastic SDIP
- Provided with 64 pin piggyback SDIP (CXP50200)

Structure

Silicon gate CMOS IC

Block Diagram

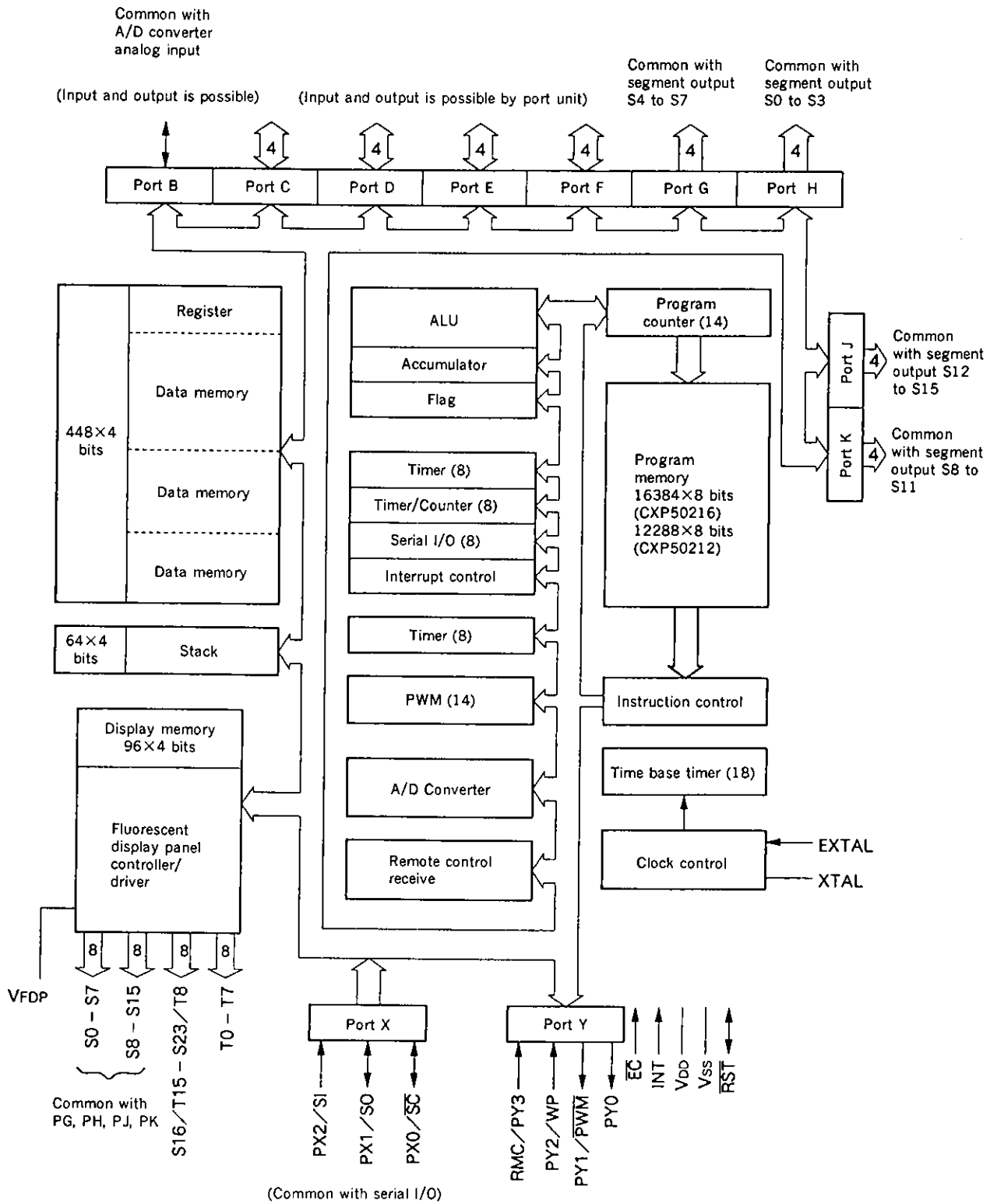

Pin Configuration (Top View)

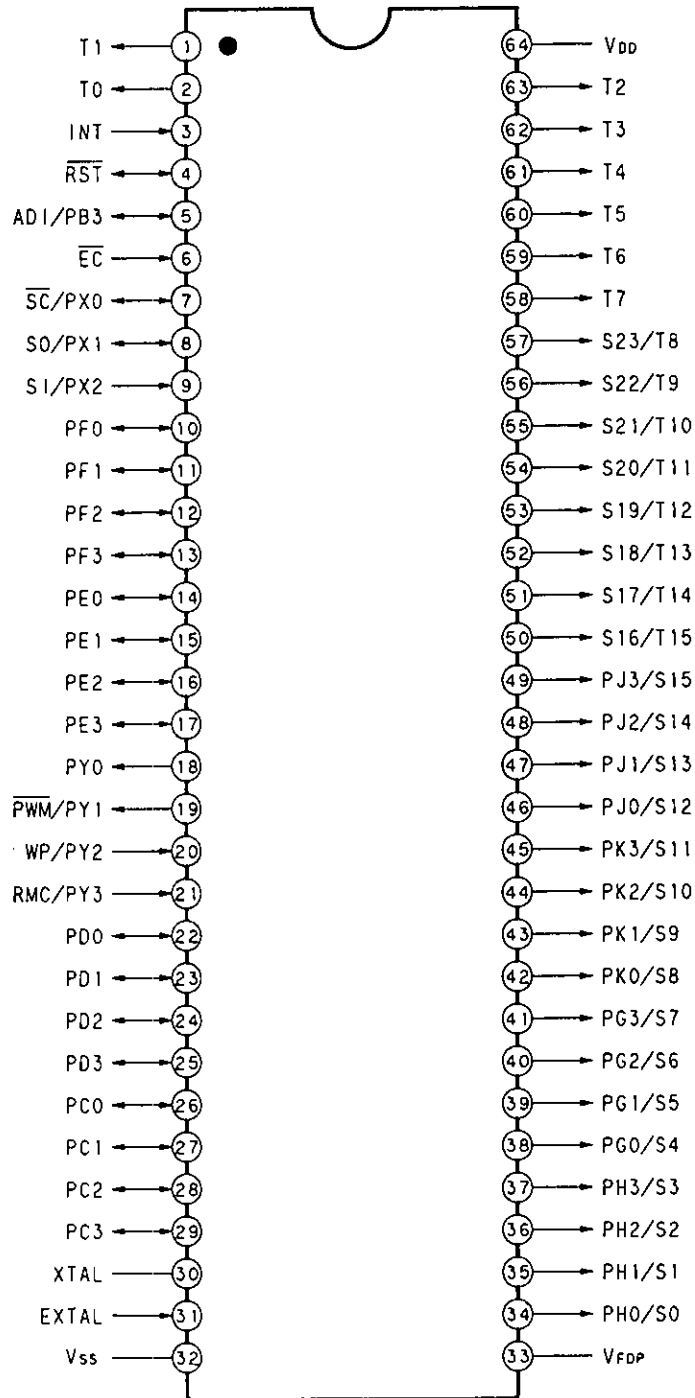

Pin Description

Symbol	Name	I/O	Description	Equivalent circuit
V _{DD}	Supply voltage	I	Positive voltage supply pin	
V _{SS}	Grounding voltage	I	GND pin	
EXTAL	Clock input	I	Clock oscillation circuit input pin. Connect the crystal oscillator or ceramic oscillator between the EXTAL and XTAL. To use an external clock input, connect the clock oscillation source to the EXTAL pin and open the XTAL pin.	
XTAL	Clock output	O	Clock oscillation circuit output pin	
RST	Reset	I/O	Serves as the incorporated power on reset circuit output pin. When inputting a reset signal from the outside, provide 2 instruction cycles or longer of an "L" level (0 V).	<p>Mask option</p> <p>Output pull-up resistor (P-ch Tr) N-ch Tr output Schmitt inverter input</p>
INT	External interrupt	I	Serves as interrupt input pin. Permits the selection with a program of the edge and the level modes.	
EC	Event counter input	I	Event counter input pin.	<p>Schmitt inverter input</p>
SI/PX2	Serial input Port X	I	Combination pin of a serial interface (8 bits) input pin and bit "2" (input) of port X.	
SO/PX1	Serial output Port X	I/O	Combination pin of a serial interface (8 bits) output pin and bit "1" (input) of port X.	<p>3-state output or pull-up resistor output possible Inverter input</p>
SC/PX0	Serial clock Port X	I/O	Combination pin of clock input/output pin for the serial interface and bit "0" (input) of port X.	<p>3-state output or pull-up resistor output possible Inverter input</p>

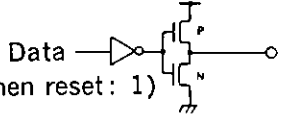
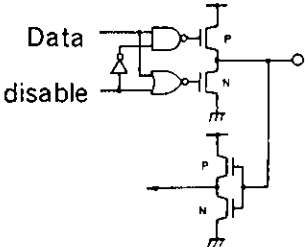
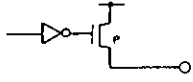
Symbol	Name	I/O	Description	Equivalent circuit
RMC/PY3	Remote control signal input Port Y	I	Combination pin of remote control receiver input pin and bit "3" (input) of port Y.	 <p>Schmitt inverter input</p>
WP/PY2	Wake-up input Port Y	I	Combination pin of a wake-up input pin to release the standby state and bit "2" (input) of port Y.	
PWM/PY1	PWM output Port Y	O	Combination pin of a PWM generator (14 bits) output and bit "1" (output) of port Y.	 <p>Inverter output</p>
PY0	Port Y	O	Output pin for bit "0" of port Y.	
PB3/ADI	Analog input Port B	I/O	This 1-bit input/output port permits its each individual port to be programmed to serve for input or output. Its output format is a 3-state or pull-up resistor output. It is also used for A/D converter input.	 <p>3-state output or pull-up resistor output possible Inverter input</p>
PC to PC3	Port C	I/O	This 4-bit input/output port permits its each individual port to be programmed to serve for input or output. Its output format is a 3-state or pull-up resistor output.	
PD0 to PD3	Port D	I/O	The same as port C.	
PE0 to PE3	Port E	I/O	The same as port C.	
PF0 to PF3	Port F	I/O	The same as port C.	
V _{FDP}	Power supply for FDP	I	Load current supply pin needed when load resistance is built in to output driver for FDP (Fluorescent Display Panel).	
T0 to T7	Timing	O	Lower 8-digit output pin of the FDP timing signal.	 <p>P-ch open drain output Pull-down resistance (Mask option)</p>
T8/S23 to T15/S16	Timing/segment	O	Combination output pin of higher 8-digit of the FDP timing signal and the segment signal.	
PG0/S4 to PG3/S7	Port G/segment	O	Combination pin of the 4-bit output port and FDP segment signal output.	
PH0/S0 to PH3/S3	Port H/segment	O	The same as port G.	
PJ0/S12 to PJ3/S15	Port J/segment	O	The same as port G.	
PK0/S8 to PK3/S11	Port K/segment	O	The same as port G.	

Absolute Maximum Ratings (Ta = -20°C to +75°C, V_{SS} = 0 V)

Item	Symbol	Ratings	Unit	Remarks
Power supply voltage	V _{DD}	-0.3 to +7.0	V	
Input voltage	V _{IN}	-0.3 to +7.0* ¹	V	
Output voltage	V _{OUT}	-0.3 to +7.0* ¹	V	
Display output voltage	V _{OD}	V _{DD} - 40 to V _{DD} + 0.3	V	As P channel transistor is open drain, V _{DD} voltage is determined as standard.
High level output current	I _{OH}	-5	mA	Other than display output pin* ² : per pin
	I _{ODH1}	-15	mA	Display output S0 to S15: per pin
	I _{ODH2}	-35	mA	Display output T0 to T7, T8/S23 to T15/S16: per pin
High level total output current	ΣI _{OH}	-40	mA	Total of other than display output pins
	ΣI _{ODH}	-100	mA	Total of display output pins
Low level output current	I _{OL}	15	mA	Port 1 pin
	I _{OLC}	20	mA	High current port 1 pin* ³
Low level total output current	ΣI _{OL}	100	mA	Entire pin total
Operating temperature	T _{opr}	-20 to +75	°C	
Storage temperature	T _{stg}	-55 to +150	°C	
Allowable power dissipation	P _D	600	mW	

*1) V_{IN} and V_{OUT} should not exceed V_{DD} + 0.3V.

*2) Specifies the output current of PB to PF, S0, SC (the general purpose I/O ports) and PY0, PY1 (Output ports).

*3) The high current drive transistors are the N channel transistors of the PC and PD ports.

Note) Usage exceeding absolute maximum ratings may permanently impair the LSI. Normal operation should better take place under the recommended operating conditions. Exceeding those conditions may adversely affect the reliability of the LSI.

Recommended Operating Conditions (V_{SS} = 0 V)

Item	Symbol	Min.	Max.	Unit	Remarks
Power supply voltage	V _{DD}	4.5	5.5	V	Guaranteed range of operation by EXTAL clock
		2.5	5.5	V	Guaranteed range of data hold during STOP
High level input voltage	V _{IH}	0.7V _{DD}	V _{DD}	V	
	V _{IHS}	0.8V _{DD}	V _{DD}	V	Hysteresis input* ¹
	V _{IHEX}	V _{DD} - 0.4	V _{DD} + 0.3	V	EXTAL pin* ²
Low level input voltage	V _{IL}	0	0.3V _{DD}	V	
	V _{ILS}	0	0.2V _{DD}	V	Hysteresis input* ¹
	V _{ILEX}	-0.3	0.4	V	EXTAL pin* ²
Operating temperature	T _{opr}	-20	+75	°C	

*1) Each of INT, EC, PX0, PX2, PY2, PY3 and RST pin.

*2) Specified only during external clock input.

Electrical Characteristics

DC characteristics (Ta = -20°C to +75°C, V_{SS} = 0 V)

Item	Symbol	Pin	Condition	Min.	Typ.	Max.	Unit
High level output voltage	V _{OH}	PB to PF, PX0, PX1 PY0, PY1	V _{DD} = 4.5V, I _{OH} = -0.5mA	4.0			V
			V _{DD} = 4.5V, I _{OH} = -1.0mA	3.5			V
Low level output voltage	V _{OL}	RST (V _{OL} only)	V _{DD} = 4.5V, I _{OL} = 1.8mA			0.4	V
			V _{DD} = 4.5V, I _{OL} = 3.6mA			0.6	V
Input current	I _{IHE} I _{IIE} I _{ILR}	EXTAL	V _{DD} = 5.5V, V _{IH} = 5.5V	0.5		40	μA
			V _{DD} = 5.5V, V _{IL} = 0.4V	-0.5		-40	μA
			V _{DD} = 5.5V, V _{IL} = 0.4V	-1.5		-400	μA
Display output current	I _{OH}	S0 to S15	V _{DD} = 4.5V V _{OH} = V _{DD} - 2.5V	-7			mA
		S16/T15 to S23/T8 T0 to T7		-18			mA
Open drain output leakage current (P-CH Tr OFF in state)	I _{LOL}	S0 to S15 S16/T15 to S23/T8 T0 to T7	V _{DD} = 5.5V V _{OL} = V _{DD} - 35V			-20	μA
Pull-down resistance*1	R _L	S0 to S15 S16/T15 to S23/T8 T0 to T7	V _{DD} = 5V V _{FDP} = V _{DD} - 35V	60	100	270	kΩ
High impedance I/O leakage current	I _{IZ}	PB to PF, PX0 to PX2, PY2, PY3, EC INT, RST*2	V _{DD} = 5.5V V _I = 0, 5.5V			±10	μA
Current supply	I _{DD} I _{DDSP} I _{DDS}	V _{DD}	V _{DD} = 5.5V, 4.19MHz crystal oscillation (C1 = C2 = 22pF) Entire output pins open		7	20	mA
			SLEEP mode		5	12	mA
			STOP mode			10	μA
Input capacity	C _{IN}	PB to PF, PX PY2, PY3, EXTAL, RST, INT, EC	fc = 1MHz 0V other than the measured pins		10	20	pF

*1) In case the incorporated pull-down resistance has been selected with mask option.

*2) RST pin specifies the input current when the pull-up resistance is selected, and specifies leakage current when nonresistance is selected.

AC characteristics

(1) Clock timing ($T_a = -20^{\circ}\text{C}$ to $+75^{\circ}\text{C}$, $V_{DD} = 4.5\text{ V}$ to 5.5 V , $V_{SS} = 0\text{ V}$)

Item	Symbol	Pin	Condition	Min.	Typ.	Max.	Unit
System clock frequency	f_c	XTAL EXTAL	Fig. 1, Fig. 2	1		5	MHz
System clock input pulse width	t_{XL} t_{XH}	EXTAL	Fig. 1, Fig. 2 External clock drive	90			ns
System clock input rising and falling times	t_{CR} t_{CF}	EXTAL	Fig.1, Fig.2 External clock drive			200	ns
Event count clock input pulse width	t_{EL} t_{EH}	$\overline{\text{EC}}$	Fig. 3	t_{sys}^{*1} $+0.05$			μs
Event count clock input rising and falling times	t_{ER} t_{EF}	$\overline{\text{EC}}$	Fig. 3			20	ms

*1) t_{sys} is $t_{\text{sys}} = 8/f_c$

*2) Specified when the crystal oscillation mode is selected by the mask option.

Note) When adjusting the frequency accurately, there may be cases in which they may differ from Fig. 2.

Fig. 1 Clock timing

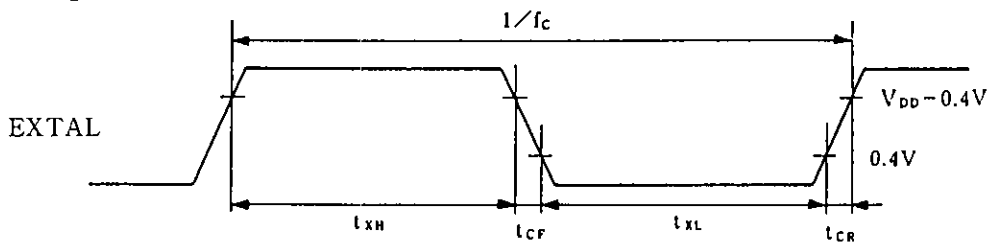

Fig. 2 Clock applying condition

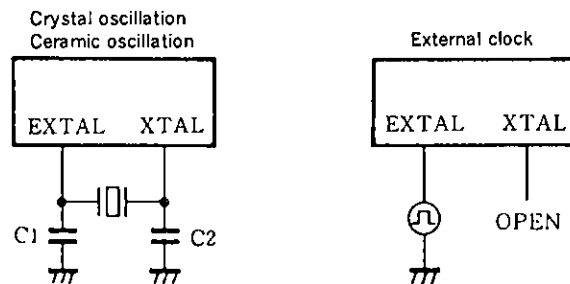
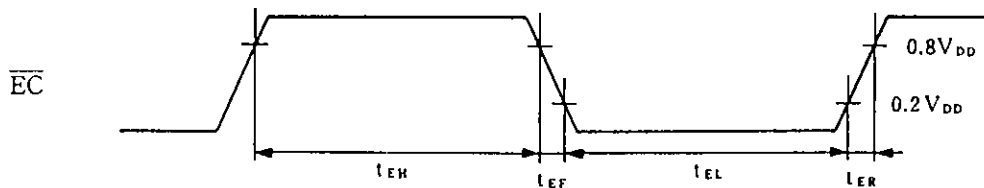

Fig. 3 Event count clock timing



(2) Serial transfer (Ta = -20°C to +75°C, V_{DD} = 4.5 V to 5.5 V, V_{SS} = 0V)

Item	Symbol	Pin	Condition	Min.	Max.	Unit
Serial transfer clock (\overline{SC}) cycle time	t_{KCY}	\overline{SC}	Input mode	$t_{sys}/4 + 1.42$		μs
			Output mode	t_{SIO}		μs
Serial transfer clock (\overline{SC}) high and low level widths	t_{KH} t_{KL}	\overline{SC}	Input mode	$t_{sys}/8 + 0.7$		μs
			Output mode	$t_{SIO}/2 - 0.1$		μs
Serial data input setup time (against \overline{SC} ↑)	t_{SIK}	SI	\overline{SC} input mode	0.1		μs
			\overline{SC} output mode	0.2		μs
Serial data input hold time (against \overline{SC} ↑)	t_{KSI}	SI	\overline{SC} input mode	$t_{sys}/8 + 0.5$		μs
			\overline{SC} output mode	0.1		μs
Data output delay time from \overline{SC} falling	t_{KSO}	SO			$t_{sys}/8 + 0.5$	μs

Note 1) t_{sys} is $t_{sys} = 8/f_c$

t_{SIO} is turned into either $2t_{sys}$, $4t_{sys}$ or $16t_{sys}$ by means of a program.

2) The load of data output delay time is 50 pF + 1 TTL.

Fig. 4 Serial transfer timing

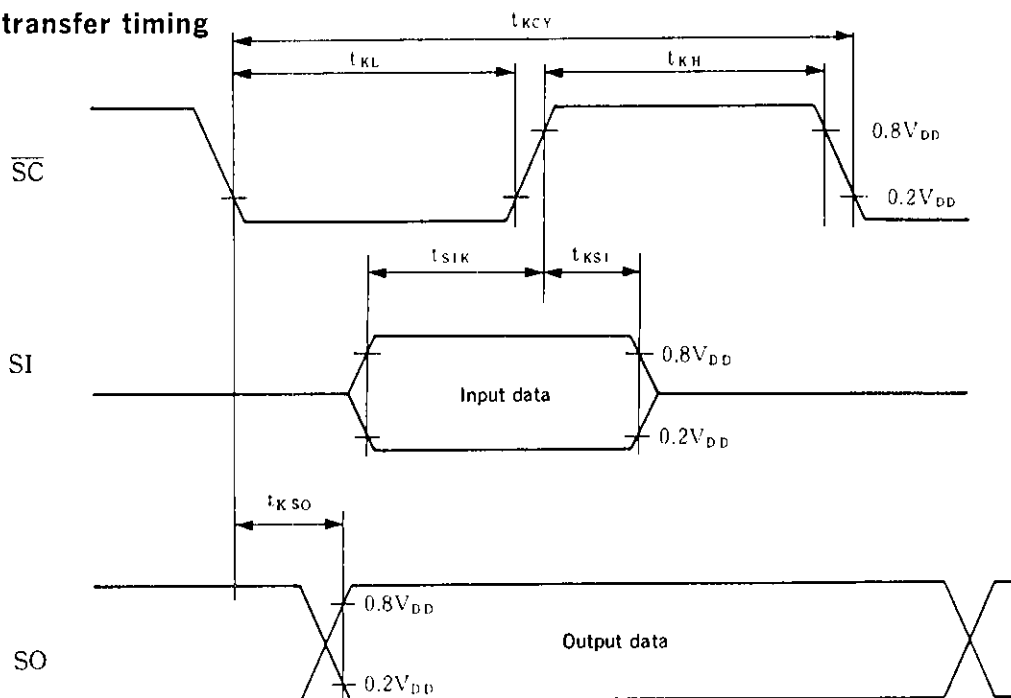

(3) A/D converter (Ta = -20°C to +75°C, V_{SS} = 0 V)

Analog input voltage	Pin	Condition	Digital conversion value
0.0 to 0.33V	ADI	V _{DD} = 5V	000
0.82 to 1.29V			001
1.78 to 2.21V			010
2.69 to 3.06V			011
3.56 to 4.06V			100
4.62 to 5.0V			101

Note) The digital conversion values are the values when FF_H address in the program are read.

(4) Others (Ta = -20°C to +75°C, V_{DD} = 4.5 V to 5.5 V, V_{SS} = 0 V)

Item	Symbol	Pin	Condition	Min.	Max.	Unit
External interruption high and low level widths	t _{I1H} , t _{I1L}	INT	Edge detection mode	tsys + 0.05		μs
Reset input low level width	t _{RSL}	RST		2tsys		μs
Wake-up input high level width	t _{WPH}	WP	STOP mode	500		μs
			SLEEP mode	tsys + 0.05		μs

Note) tsys is tsys = 8/f_c

Fig. 5 Interruption input timing

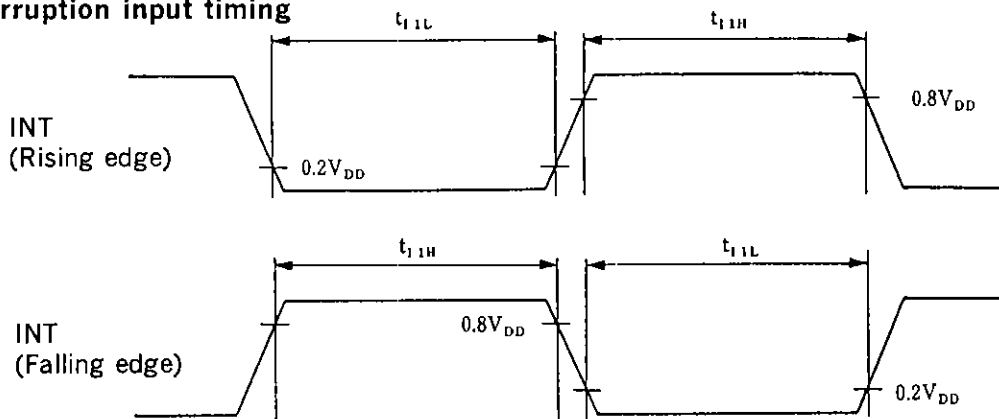

Fig. 6 RST input timing

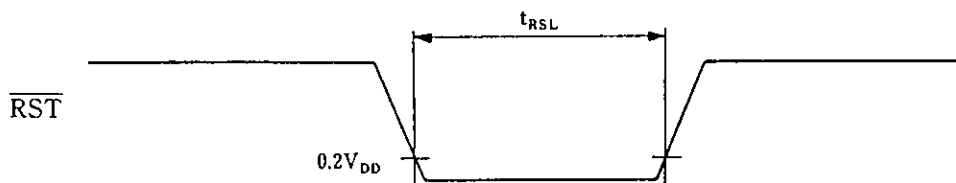
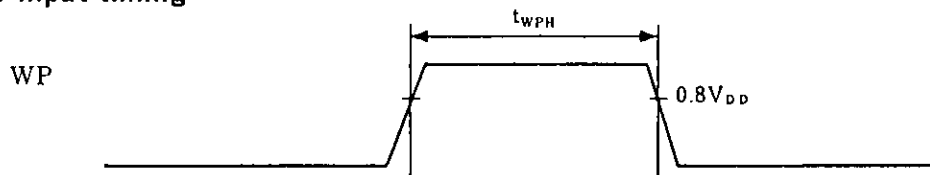

Fig. 7 Wake-up input timing



Power on reset* (Ta = -20°C to +75°C, V_{SS} = 0 V)

Item	Symbol	Pin	Condition	Min.	Max.	Unit
Power supply rising time	t _R	V _{DD}	Power on reset	0.05	50	ms
Power supply cut-off time	t _{OFF}		Repetitive power on reset	1		ms

* Specifies only when power on reset function is selected.

Fig. 8 Power on reset

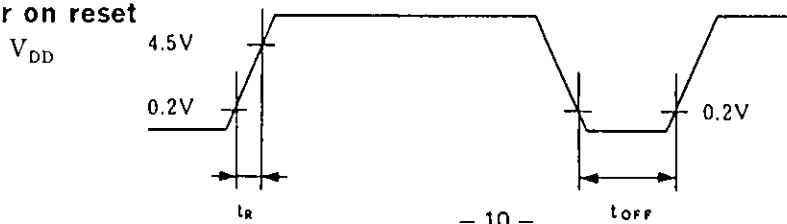

The power supply should rise smoothly.

Notes on Operation

See Fig. 9, additive capacity calculation chart, when using the crystal oscillator and select the appropriate capacity.

Fig. 9 Crystal oscillation circuit additive capacity calculation chart
($T_a = -20$ to $+75^\circ\text{C}$, $V_{DD} = 4.5$ to 5.5 V)

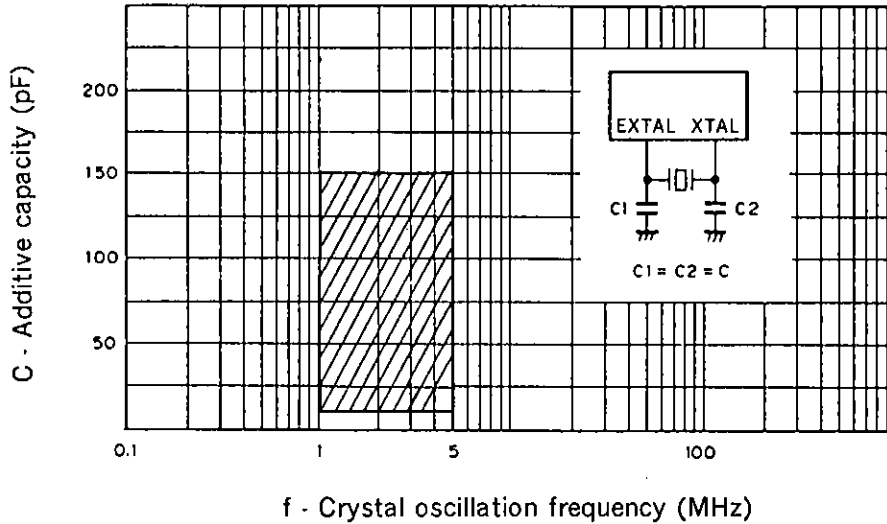

Note) The above chart shows a range in which the average quartz resonator has a relatively fast oscillation rising edge and stable characteristics. The capacity should be selected to correspond to the appropriate constant for each quartz resonator, should the frequency of the quartz resonator be accurately adjusted.

Fig. 10 shows recommended circuits and oscillators. Use the trimmer capacitor to C1, in the case of accurate adjustment of the oscillation frequency.

Fig. 10 Recommended oscillation circuit

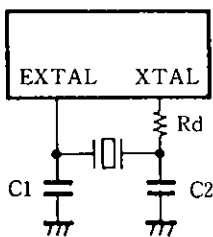

Manufacturer	Model	Frequency	C1	C2	Rd
MURATA MFG CO., LTD.	CSA4.19MG040	4.19 MHz	100pF	100pF	—
	CST4.19MGW040	4.19 MHz	— (built in)	— (built in)	—

Manufacturer	Model	Frequency	C1	C2	Rd
CITIZEN WATCH CO., LTD.	CSA-309	4.19 MHz	10pF (20pF trimmer)	10pF	—
NIHON DENPA KOGYO CO., LTD.	AT-51	4.19 MHz	15pF (20pF trimmer)	15pF	6.8kΩ
KINSEKI LTD.	HC-49/U-S	4.19 MHz	22pF	22pF	3.3kΩ

When using the A/D converter as the key input, it is recommended that the circuit structure shown in Fig. 11 be used.

Fig. 11 Recommended example of key circuit by A/D converter

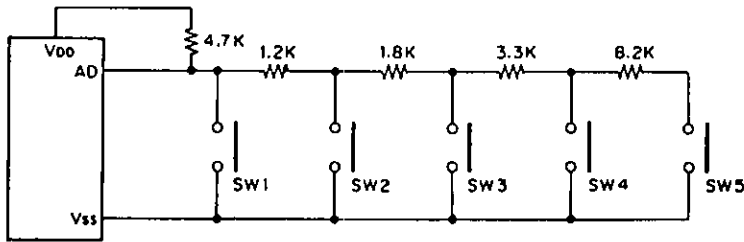

(Precision of resistance is all within $\pm 5\%$)

Package Outline Unit: mm

64pin SDIP (Plastic) 750mil 8.6g

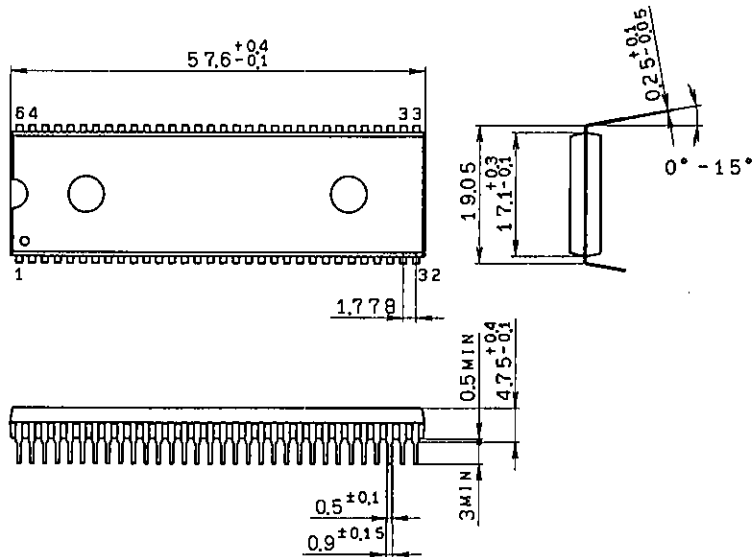

SONY NAME	SOIP-64P-01
EIAJ NAME	SDIP064-P-0750-A
JEDEC CODE	