

## ***CS1601 120W, High-efficiency PFC + Fluorescent Lamp Driver Reference Design***

### **Features**

- ❑ Line Voltage Range: 108 to 305 VACrms
- ❑ Output Voltage ( $V_{link}$ ): 460V
- ❑ Rated Maximum  $P_{in}$ : 120W
- ❑ Spread Spectrum Switching Frequency
- ❑ Integrated Digital Feedback Control
- ❑ Low Component Count

### **General Description**

The CRD1601-120W board demonstrates the performance of the CS1601 digital PFC controller in an electronic ballast application. The CRD1601 uses a resonant second stage driver to power up to two T5 fluorescent lamps. The CRD1601 has been designed to fit into a slimline T5 fluorescent electronic ballast form-factor.

### **ORDERING INFORMATION**

CRD1601-120W PFC Customer Reference Design



Actual Size:  
356 mm x 27 mm  
14.0 in x 1.07 in



## IMPORTANT SAFETY INSTRUCTIONS

**Read and follow all safety instructions prior to using this demonstration board.**

This Engineering Evaluation Unit or Demonstration Board must only be used for assessing IC performance in a laboratory setting. This product is not intended for any other use or incorporation into products for sale.

This product must only be used by qualified technicians or professionals who are trained in the safety procedures associated with the use of demonstration boards.

### **⚠ DANGER Risk of Electric Shock**

- The direct connection to the AC power line and the open and unprotected boards present a serious risk of electric shock and can cause serious injury or death. Extreme caution needs to be exercised while handling this board.
- Avoid contact with the exposed conductor or terminals of components on the board. High voltage is present on exposed conductor and it may be present on terminals of any components directly or indirectly connected to the AC line.
- Dangerous voltages and/or currents may be internally generated and accessible at various points across the board.
- Charged capacitors store high voltage, even after the circuit has been disconnected from the AC line.
- Make sure that the power source is off before wiring any connection. Make sure that all connectors are well connected before the power source is on.
- Follow all laboratory safety procedures established by your employer and relevant safety regulations and guidelines, such as the ones listed under, OSHA General Industry Regulations - Subpart S and NFPA 70E.

**⚠ WARNING** Suitable eye protection must be worn when working with or around demonstration boards. Always comply with your employer's policies regarding the use of personal protective equipment.

**⚠ WARNING** All components, heat sinks or metallic parts may be extremely hot to touch when electrically active.

**⚠ WARNING** Heatsinking is required for Q4 & Q5. The end product should use tar pitch or an equivalent compound for this purpose. For lab evaluation purposes, a fan is recommended to provide adequate cooling.

---

## Contacting Cirrus Logic Support

For all product questions and inquiries contact a Cirrus Logic Sales Representative. To find the one nearest to you go to [www.cirrus.com](http://www.cirrus.com)

---

### IMPORTANT NOTICE

Cirrus Logic, Inc. and its subsidiaries ("Cirrus") believe that the information contained in this document is accurate and reliable. However, the information is subject to change without notice and is provided "AS IS" without warranty of any kind (express or implied). Customers are advised to obtain the latest version of relevant information to verify, before placing orders, that information being relied on is current and complete. All products are sold subject to the terms and conditions of sale supplied at the time of order acknowledgment, including those pertaining to warranty, indemnification, and limitation of liability. No responsibility is assumed by Cirrus for the use of this information, including use of this information as the basis for manufacture or sale of any items, or for infringement of patents or other rights of third parties. This document is the property of Cirrus and by furnishing this information, Cirrus grants no license, express or implied under any patents, mask work rights, copyrights, trademarks, trade secrets or other intellectual property rights. Cirrus owns the copyrights associated with the information contained herein and gives consent for copies to be made of the information only for use within your organization with respect to Cirrus integrated circuits or other products of Cirrus. This consent does not extend to other copying such as copying for general distribution, advertising or promotional purposes, or for creating any work for resale.

CERTAIN APPLICATIONS USING SEMICONDUCTOR PRODUCTS MAY INVOLVE POTENTIAL RISKS OF DEATH, PERSONAL INJURY, OR SEVERE PROPERTY OR ENVIRONMENTAL DAMAGE ("CRITICAL APPLICATIONS"). CIRRUS PRODUCTS ARE NOT DESIGNED, AUTHORIZED OR WARRANTED FOR USE IN PRODUCTS SURGICALLY IMPLANTED INTO THE BODY, AUTOMOTIVE SAFETY OR SECURITY DEVICES, LIFE SUPPORT PRODUCTS OR OTHER CRITICAL APPLICATIONS. INCLUSION OF CIRRUS PRODUCTS IN SUCH APPLICATIONS IS UNDERSTOOD TO BE FULLY AT THE CUSTOMER'S RISK AND CIRRUS DISCLAIMS AND MAKES NO WARRANTY, EXPRESS, STATUTORY OR IMPLIED, INCLUDING THE IMPLIED WARRANTIES OF MERCHANTABILITY AND FITNESS FOR PARTICULAR PURPOSE, WITH REGARD TO ANY CIRRUS PRODUCT THAT IS USED IN SUCH A MANNER. IF THE CUSTOMER OR CUSTOMER'S CUSTOMER USES OR PERMITS THE USE OF CIRRUS PRODUCTS IN CRITICAL APPLICATIONS, CUSTOMER AGREES, BY SUCH USE, TO FULLY INDEMNIFY CIRRUS, ITS OFFICERS, DIRECTORS, EMPLOYEES, DISTRIBUTORS AND OTHER AGENTS FROM ANY AND ALL LIABILITY, INCLUDING ATTORNEYS' FEES AND COSTS, THAT MAY RESULT FROM OR ARISE IN CONNECTION WITH THESE USES.

Cirrus Logic, Cirrus, and the Cirrus Logic logo designs are trademarks of Cirrus Logic, Inc. All other brand and product names in this document may be trademarks or service marks of their respective owners.

## 1. INTRODUCTION

The CS1601 is a high-performance Variable Frequency Discontinuous Conduction Mode (VF-DCM), active Power Factor Correction (PFC) controller, optimized to deliver the lowest PFC system cost for electronic ballast applications. The CS1601 uses a digital control algorithm that is optimized for high efficiency and near unity power factor over a wide input voltage range (108-305 VAC).

The CS1601 uses an adaptive digital control algorithm. Both the ON time and the switching frequency are varied on a cycle-by-cycle basis over the entire AC line to achieve close to unity power factor. The variation in switching frequency also provides a spread frequency spectrum, thus minimizing the conducted EMI filtering requirements.

The feedback loop is closed through an integrated digital control system within the IC. Protection features such as overvoltage, overcurrent, overpower, open circuit, overtemperature, and brownout help protect the device during abnormal transient conditions. Details of these features are provided in the CS1601 data sheet.

The CRD1601-120W board demonstrates the performance of the CS1601 over a wide input voltage range. This board has been designed to generate 460V from the PFC stage, which is then processed by the resonant driver, to power up to two T5 lamps connected in series, for a total output of 108W.

Extreme caution needs to be exercised while handling this board. This board should be energized by trained professionals only.

Terminal block J1 is used to connect the AC line. The lamp is connected to terminal J2 as shown in the schematic.



**Figure 1. Board Connections**



**DANGER**  
**High Voltage Hazard**  
 ONLY QUALIFIED PERSONNEL SHOULD HANDLE THE CRD1601-120W.



**Warning:**

Heatsinking is required for Q4 & Q5.

The end product should use tar pitch or an equivalent compound for this purpose.  
 For lab evaluation purposes, a fan is recommended to provide adequate cooling.

2. SCHEMATIC

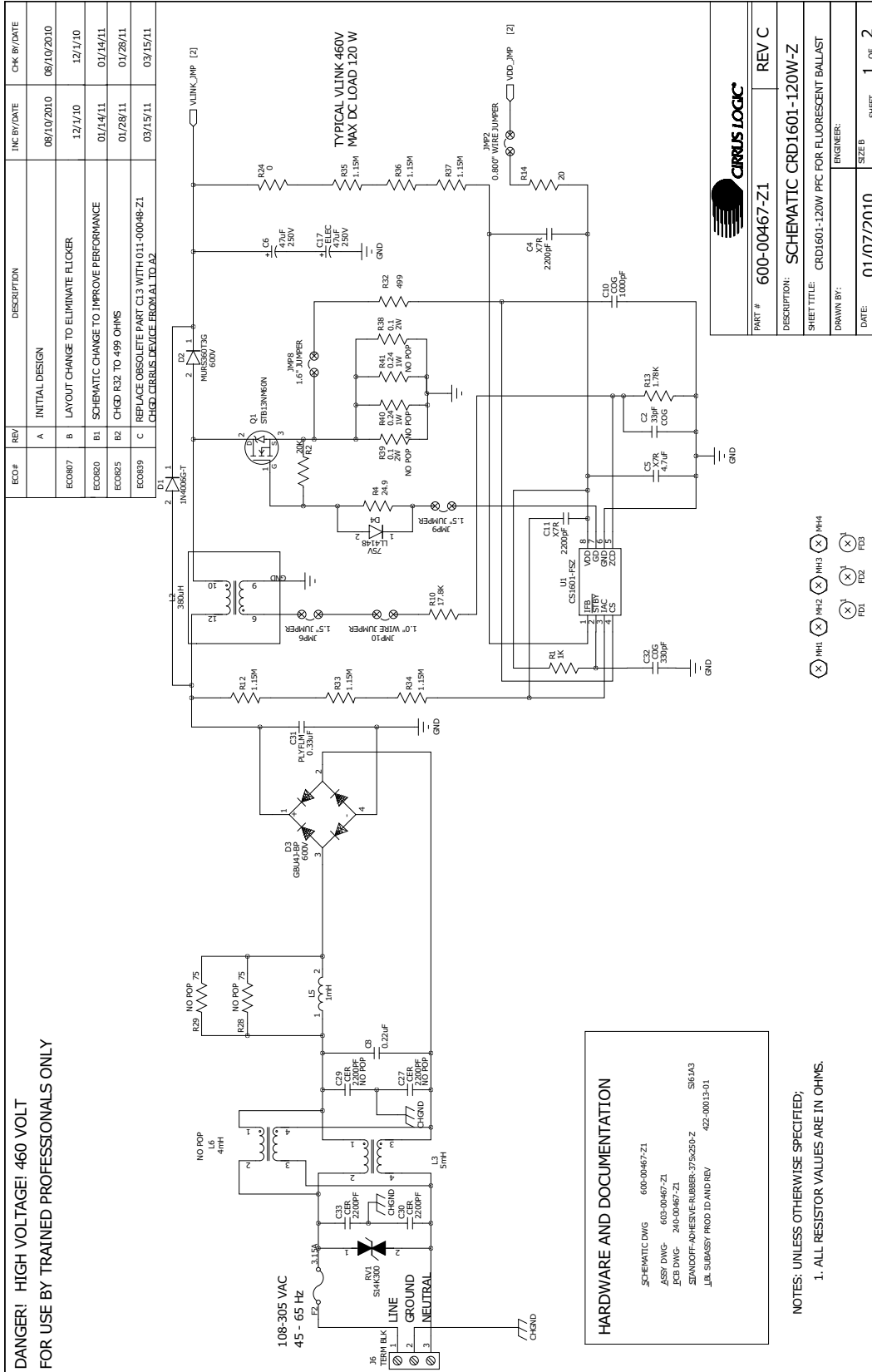



**3. BILL OF MATERIALS**

BILL OF MATERIAL (Page 1 of 2)

 CIRRUS LOGIC  
 CRD1601-120W\_REV\_C

Item	Cirrus P/N	Rev	Description	Qty	Reference Designator	MFG	MFG P/N	Notes
1	001-10235-Z1	A	CAP 0.33uF ±10% 50V XTR NPB 1206	3	C1 C3 C25	KEMET	C1206C334K5RAC	
2	001-05280-Z1	A	CAP 33pF ±5% 50V COG NPB 1206	1	C2	KEMET	C1206C330J5GAC	
3	001-06276-Z1	A	CAP 2200pF ±10% 50V XTR NPB 1206	2	C4 C11	KEMET	C1206C222K5RAC	
4	001-10233-Z1	A	CAP 4.7uF ±20% 25V XTR NPB 1206	1	C5	TDK	C3216X7R1E475M	
5	012-00186-Z1	A	CAP 47uF ±20% 250V ELEC NPB RAD	2	C6 C17	NICHICON	UVZ2E470MHD	
6	013-00037-Z1	A	CAP 0.15uF ±10% 250V POLY NPB RAD	3	C7 C12 C14	EPCOS	B32529C3154K	
7	011-00064-Z1	A	CAP 0.22uF ±20% 330V PLY FILM NPB TH	1	C8	EPCCOS	B32912B3224M	ECO0839
8	001-06516-Z1	A	CAP 5600pF ±10% 50V XTR NPB 1206	1	C9	KEMET	C1206C562K5RAC	
9	001-06036-Z1	A	CAP 1000pF ±10% 50V COG NPB 1206	1	C10	KEMET	C1206C102K5GAC	
10	011-00048-Z1	A	CAP 270pF ±10% 1kV CER NPB RAD	1	C13	TDK	CK45-R3AD271K-NR	ECO0839
11	011-00046-Z1	A	CAP 330pF ±10% 2kV CER NPB RAD	1	C15	TDK	CK45-R3D331K-NR	
12	013-00027-Z1	A	CAP 0.1uF ±10% 630V POLY NPB RAD	1	C16	PANASONIC	ECO6104KF	
13	001-06838-Z1	A	CAP 0.088uF ±10% 50V XTR NPB 1206	1	C18	KEMET	C1206C883K5RAC	
14	011-00045-Z1	A	CAP 1000PF ±10% 500V XTR NPB RAD	1	C19	VISHAY/SPRAGUE	562R5TSD10	
15	001-06709-Z1	A	CAP 0.022uF ±5% 50V XTR NPB 1206	1	C20	KEMET	C1206C223J5RAC	
16	001-06542-Z1	A	CAP 100pF ±5% 50V COG NPB 1206	1	C21	KEMET	C1206C101J5GAC	
17	001-06948-Z1	A	CAP 0.22uF ±10% 50V XTR NPB 1206	1	C22	KEMET	C1206C224K5RAC	
18	001-06821-Z1	A	CAP 0.066uF ±10% 50V XTR NPB 1206	1	C23	KEMET	C1206C663K5RAC	
19	001-06548-Z1	A	CAP 6800pF ±10% 50V XTR NPB 1206	1	C24	KEMET	C1206C682K5RAC	
20	001-10225-Z1	A	CAP 0.10uF 10% 25V XTRLESR NPB 0603	1	C26	MURATA	GRM188R71E104KA01D	NO POP
21	011-00049-Z1	A	CAP 2200pF ±20% DISC 500V RAD NPB	0	C27 C29	VISHAY	YY1222M475UJ063V0	
22	013-00026-Z1	A	CAP 4.7nF ±5% 1600V POLY NPB RAD	1	C28	EPCOS	B32612A1472J008	
23	011-00049-Z1	A	CAP 2200pF ±20% DISC 500V RAD NPB	2	C30 C33	VISHAY	YY1222M475UJ063V0	
24	013-00034-Z1	A	CAP 0.33uF ±10% 630V POLY NPB RAD	1	C31	PANASONIC	ECO6334KF	
25	011-00059-Z1	A	CAP 330pF ±5% 100V COG C315 NPB TH	1	C32	KEMET	C315C331J1G5CA	FORM LEADS TO MATCH LAYOUT
26	070-00132-Z1	A	DIODE RECT 800V 1A 20mA NPB DO-41	1	D1	DIODES INC	IN4006G-T	
27	070-00166-Z1	A	DIODE RECT 600V 4A ULT FST NPB SMC	1	D2	MURS360T3G	MURS360T3G	
28	070-00157-Z1	A	DIODE RECT BRIDGE 600V 4A NPB GBU	1	D3	MICRO COMMERCIAL CO	GBU4J-BP	
29	070-00001-Z1	A	DIODE SS 75V 500mA NPB SOD80	1	D4	DIODES INC	LL4148	
30	180-00022-Z1	A	FUSE 3.15A TLAG IEC NPB SHORT TRS	1	F2	LITTLE FUSE	37213150411	
31	110-00321-Z1	A	CON TERM BLK 6X7 FML RA GRN NPB TH	1	J2	PHOENIX CONTACT	1727052	
32	110-00301-Z1	A	CON 3POS TERM BLK 5.08mm SPR NPB RA	1	J6	WEIDMULLER	1716030000	
33	080-00013-Z1	A	WIRE 24 AWG SOLID PVC INS BLK NPB	10	JMP1 JMP2 JMP3 JMP4 JMP5 JMP6 JMP7 JMP8 JMP9 JMP 10	ALPHA WIRE COMPANY	3050V1 BK005	SEE ASSY DWG FOR LENGTH
34	050-00050-Z1	A	XFMR 380uH 10% .2650 NPB TH	1	L2	RENCO	RLCS-1005	
35	050-00039-Z1	A	XFMR 5mH 1:1 1500Vrms 4PIN NPB TH	1	L3	PREMIER MAGNETICS	TSD-2796	
36	040-00127-Z1	A	IND 1mH 1.3A ±15% TOR VERT NPB TH	1	L5	BOURNS	2124-V-RC	
37	050-00047-Z1	A	XFMR COMMON MODE CHOKE 1.3 A TH NPB	0	L6	RENCO	RL-4400-2-4.00	NO POP
38	304-00001-Z1	A	SPCR STANDOFF 4-40 THR .875L AL NPB	0	MH1 MH2 MH3 MH4	KEYSTONE	1809	INSTALL RUBBER FEET SJ61A3
39	071-00108-Z1	A	TRAN MOSFET nCH 11A 600V NPB D2PAK	1	Q1	ST MICROELECTRONICS	STB13NM60N	
40	071-00092-Z1	A	TRAN MOSFET nCH 69W NPB TO220-3	2	Q4 Q5	INFINEON	SPP04N60C3	
41	030-00010-Z1	A	RES 1K 1/4W ±1% METAL FILM NPB AXL	1	R1	VISHAY	CCF551K00FKE36	
42	020-06310-Z1	A	RES 20K OHM 1/4W ±1% NPB 1206 FILM	1	R2	DALE	RCRW120620K0FKEA	
43	020-06347-Z1	A	RES 2.00 OHM 1/4W ±1% NPB 1206	3	R3 R11 R25	DALE	RCRW12062R00FKEA	
44	020-06337-Z1	A	RES 24.9 OHM 1/4W ±1% NPB 1206 FILM	1	R4	DALE	RCRW120624R9FKEA	
45	021-00544-Z1	A	RES 33 OHM 1/4W ±5% NPB 1206 FILM	1	R5	DALE	RCRW120633R0JNEA	
46	031-00052-Z1	A	RES 330K OHM 1/4W ±5% CARB NPB AXL	2	R7 R8	PANASONIC	ERD-52TJ334V	
47	020-06390-Z1	A	RES 17.8K OHM 1/4W ±1% NPB 1206	1	R10	DALE	RCRW120617K8FKEA	
48	020-06356-Z1	A	RES 1.15M OHM 1/4W ±1% NPB 1206	6	R12 R33 R34 R35 R36 R37	DALE	RCRW12061M15FKEA	
49	020-06391-Z1	A	RES 1.78K OHM 1/4W ±1% NPB 1206	1	R13	DALE	RCRW12061K78FKEA	
50	020-06324-Z1	A	RES 20 OHM 1/4W ±1% NPB 1206 FILM	1	R14	DALE	RCRW120620R0FKEA	
51	020-06343-Z1	A	RES 8.25K OHM 1/4W ±1% NPB 1206	2	R16 R18	DALE	RCRW12068K25FKEA	
52	020-06345-Z1	A	RES 61.9K OHM 1/4W ±1% NPB 1206	1	R17	DALE	RCRW120661K9FKEA	
53	020-06346-Z1	A	RES 33.2K OHM 1/4W ±1% NPB 1206	1	R19	DALE	RCRW120633K2FKEA	
54	020-06342-Z1	A	RES 221K OHM 1/4W ±1% NPB 1206 FILM	1	R20	DALE	RCRW1206221K FKEA	
55	020-06344-Z1	A	RES 8.06K OHM 1/4W ±1% NPB 1206	1	R21	DALE	RCRW12068K06FKEA	
56	021-06319-Z1	A	RES 3 OHM 1/2W ±5% NPB 1210 FILM	2	R22 R23	PANASONIC	ERJ14YJ3R00	
57	020-02273-Z1	A	RES 0 OHM 1/4W NPB 1206 FILM	2	R24 R30	DALE	RCRW12060000Z0EA	
58	020-02467-Z1	A	RES 48.9 OHM 1/4W ±1% NPB 1206 FILM	1	R26	DALE	RCRW12064898FKEA	

**BILL OF MATERIAL (Page 2 of 2)**
**CIRRUS LOGIC  
CRD1601-120W\_REV\_C**

Item	Cirrus P/N	Rev	Description	Qty	Reference Designator	MFG	MFG P/N	Notes
59	020-02520-Z1	A	RES 150 OHM 1/4W ±1% NPb 1206 FILM	1	R27	DALE	CRCW1206150RFFKEA	
60	020-02488-Z1	A	RES 75 OHM 1/4W ±1% NPb 1206 FILM	0	R28 R29	DALE	CRCW120675R0FKEA	NO POP
61	020-02581-Z1	A	RES 499 OHM 1/4W ±1% NPb 1206 FILM	1	R32	DALE	CRCW1206499RFFKEA	ECO0825
62	030-00081-Z1	A	RES 0.1 OHM 2W ±1% WW NPb AXL	1	R38	VISHAY	G003R1000FE7080	
63	030-00091-Z1	A	RES 0.1 OHM 2W ±1% WW NPb AXL	0	R39	VISHAY	G003R1000FE7080	NO POP
64	020-06372-Z1	A	RES 0.24 OHM 1W ±1% NPb 2512	0	R40 R41	PANASONIC	ERJ1TRQFR24U	NO POP
65	036-00015-Z1	A	VARIABLE 470V RMS 14MM NPb RAD	1	RV1	PERCOS	S14K300	
66	060-00042-Z1	A	XFMR 1.3mH 200DVac 10PIN NPb TH	1	T1	PREMEIR	TSD-2709	
67	110-00045-Z1	A	CON TEST PT .1"CTR TIN PLAT NPb BLK	0	TP1 TP2	KEYSTONE	5001	NO POP
68	065-00331-Z3	A2	IC CRUS LPWR FACTOR CORR NPb SOIC8	1	U1	CIRRUS LOGIC	CS1601-FSZ/A2	ECO0839
69	060-00477-Z1	A	IC CNTL BALLAST 600V NPb SOIC16	1	U2	NXP	UBA2014T/N1,518	
70	305-00005-Z1	A	FEET PROT ADH BACK .375x.25 BLK NPb	4	XMH1 XMH2 XMH3 XMH4	3M	SJ61A3	SEE ASSEMBLY DRAWING
71	070-00007-Z1	A	DIODE FAST SW 75V 350mA NPb SOD123	4	Z1 Z2 Z9 Z14	DIODES INC	1N4148W-7-F	
72	070-00194-Z1	A	DIODE ZEN 14V 150HM 500mA NPb DO-35	1	Z3	FAIRCHILD SEMICONDUCTOR	1N5244B	
73	070-00196-Z1	A	DIODE RECT 200V 1A SMA NPb DO-214AC	1	Z13	TAIWAN SEMICONDUCTOR	ES1D	
74	070-00195-Z1	A	DIODE ZENER 500mW 15V 8.5mA MINIMILF	1	Z16	NXP	BZV55-B15,115	
75	603-00467-Z1	C	ASSY DWG CRD1601-120W-Z-NPb	REF		CIRRUS LOGIC	603-00467-Z1	
76	422-00013-01	C	LBL SUBASSY PRODUCT ID AND REV	1		CIRRUS LOGIC	422-00013-01	
77	240-00467-Z1	C	PCB CRD1601-120W-Z-NPb	REF		CIRRUS LOGIC	240-00467-Z1	
78	600-00467-Z1	C	SCHEM CRD1601-120W-Z-NPb	REF		CIRRUS LOGIC	600-00467-Z1	ECO0820/0825/0839

4. BOARD LAYOUT

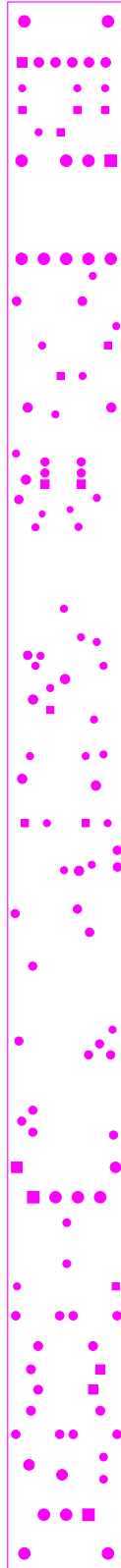
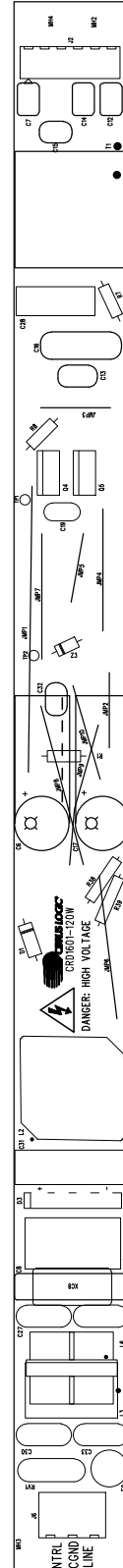

Figure 2. Solder Mask (Top)





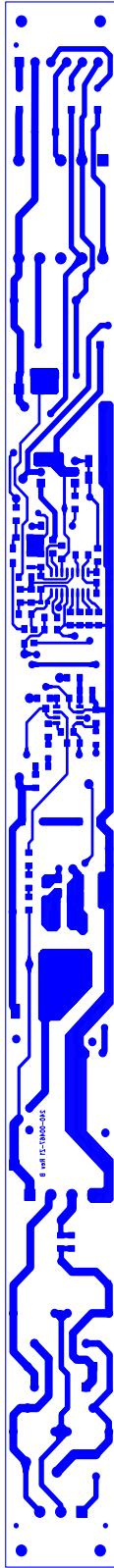

Figure 4. Circuit Routing (Bottom)



Figure 5. Solder Paste Mask (Bottom)

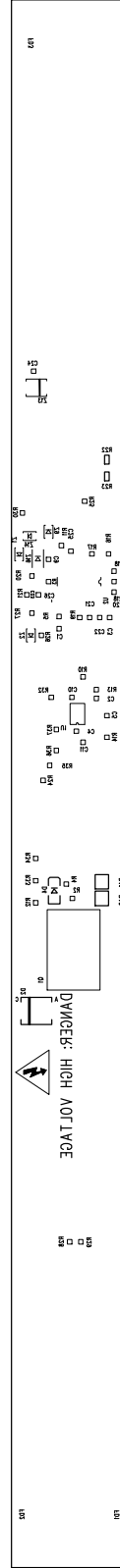
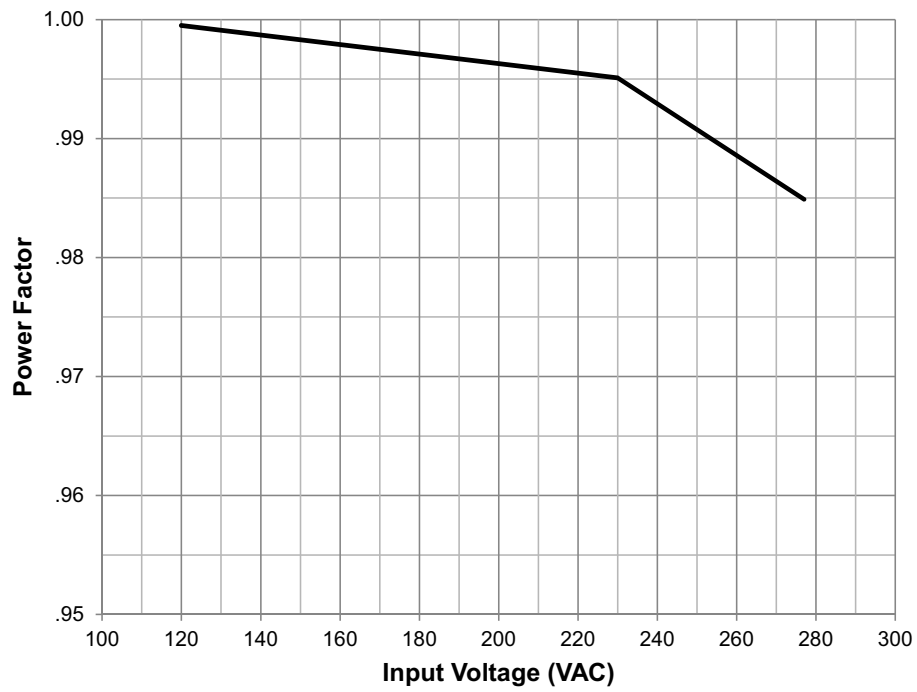
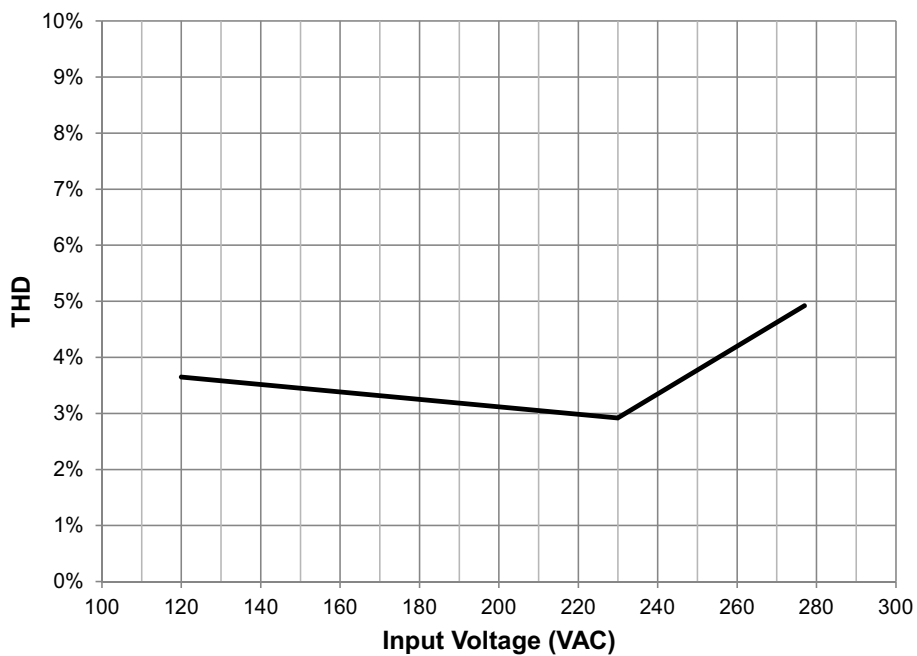

Figure 6. Silkscreen (Bottom)



Figure 7. Solder Mask (Bottom)

**5. PERFORMANCE PLOTS**

**Figure 8. Power Factor vs. AC Input Voltage**

**Figure 9. THD vs. AC Input Voltage**

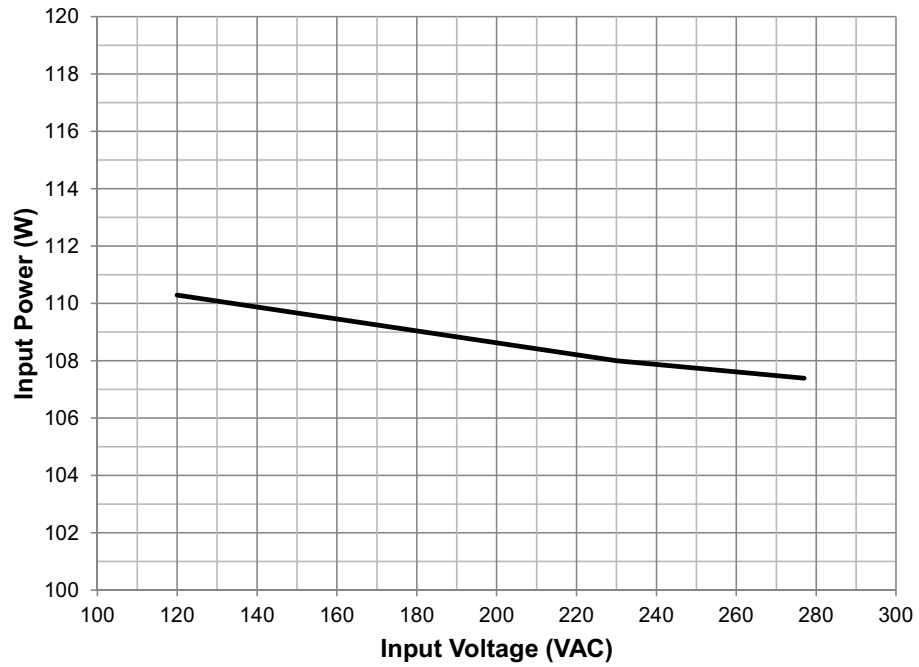

Figure 10. Input Power vs. AC Input Voltage

**6. REVISION HISTORY**

<b>Revision</b>	<b>Date</b>	<b>Changes</b>
RD1	FEB 2011	Initial Release.
RD2	FEB 2011	Minor BOM & schematic change to eliminate possible flicker.
RD3	MAR 2011	Updated BOM, Schematic, and layers to rev C (rev A2 Cirrus device).