

CR3PM

LOW POWER USE
INSULATED TYPE, GLASS PASSIVATION TYPE

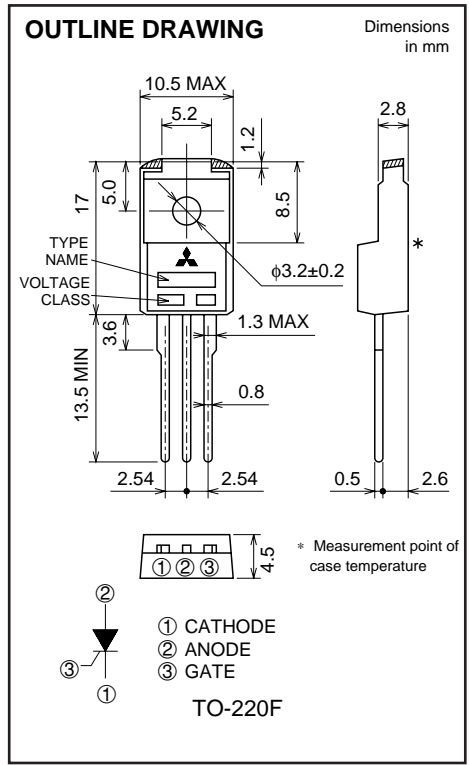
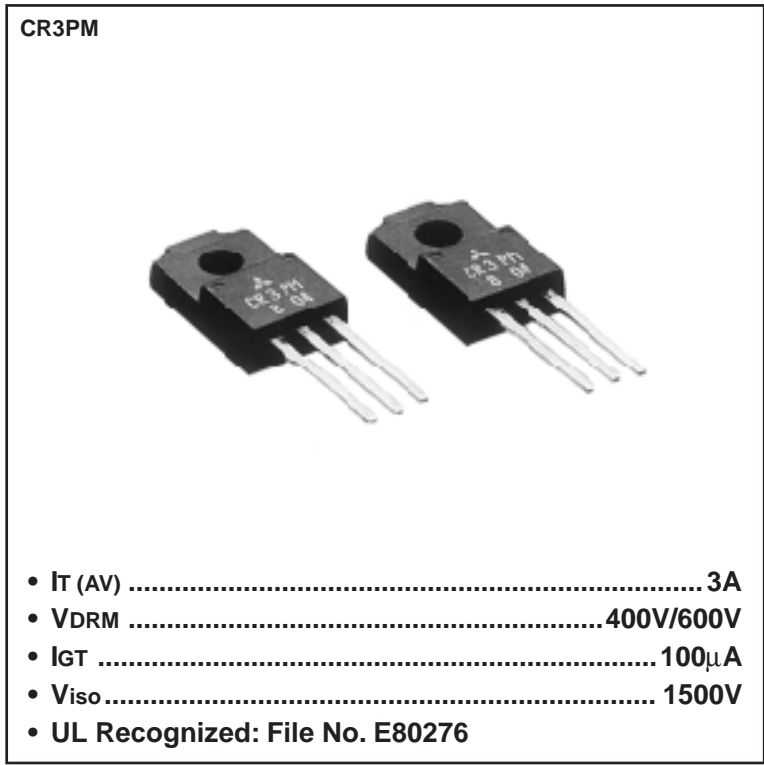

APPLICATION

TV sets, control of household equipment such as electric blankets, other general purpose control applications

MAXIMUM RATINGS ($T_a=25^\circ\text{C}$, unless otherwise noted)

Symbol	Parameter	Voltage class		Unit
		8	12	
V_{RRM}	Repetitive peak reverse voltage	400	600	V
V_{RSM}	Non-repetitive peak reverse voltage	500	720	V
V_R (DC)	DC reverse voltage	320	480	V
V_{DRM}	Repetitive peak off-state voltage *1	400	600	V
V_D (DC)	DC off-state voltage *1	320	480	V

Symbol	Parameter	Conditions	Ratings	Unit
I_T (RMS)	RMS on-state current		4.7	A
I_T (AV)	Average on-state current	Commercial frequency, sine half wave, 180° conduction, $T_c=103^\circ\text{C}$	3.0	A
I_{TSM}	Surge on-state current	60Hz sine half wave 1 full cycle, peak value, non-repetitive	70	A
i^2t	i^2t for fusing	Value corresponding to 1 cycle of half wave 60Hz, surge on-state current	24.5	A ² s
PGM	Peak gate power dissipation		0.5	W
PG (AV)	Average gate power dissipation		0.1	W
V_{FGM}	Peak gate forward voltage		6	V
V_{RGM}	Peak gate reverse voltage		6	V
I_{FGM}	Peak gate forward current		0.3	A
T_j	Junction temperature		-40 ~ +125	$^\circ\text{C}$
T_{stg}	Storage temperature		-40 ~ +125	$^\circ\text{C}$
—	Weight	Typical value	2.0	g
V_{iso}	Isolation voltage	$T_a=25^\circ\text{C}$, AC 1 minute, each terminal to case	1500	V

*1. With gate to cathode resistance $R_{GK}=220\Omega$.

CR3PM

LOW POWER USE

INSULATED TYPE, GLASS PASSIVATION TYPE

ELECTRICAL CHARACTERISTICS

Symbol	Parameter	Test conditions	Limits			Unit
			Min.	Typ.	Max.	
IRRM	Repetitive peak reverse current	$T_j=125^{\circ}\text{C}$, V_{RRM} applied, $R_{GK}=220\Omega$	—	—	2.0	mA
IDRM	Repetitive peak off-state current	$T_j=125^{\circ}\text{C}$, V_{DRM} applied, $R_{GK}=220\Omega$	—	—	2.0	mA
V _{TM}	On-state voltage	$T_c=25^{\circ}\text{C}$, $I_{TM}=10\text{A}$, instantaneous value	—	—	1.6	V
V _{GT}	Gate trigger voltage	$T_j=25^{\circ}\text{C}$, $V_D=6\text{V}$, $I_T=0.1\text{A}$	—	—	0.8	V
V _{GD}	Gate non-trigger voltage	$T_j=125^{\circ}\text{C}$, $V_D=1/2V_{DRM}$, $R_{GK}=220\Omega$	0.1	—	—	V
I _{GT}	Gate trigger current	$T_j=25^{\circ}\text{C}$, $V_D=6\text{V}$, $I_T=0.1\text{A}$	1	—	100* ³	μA
R _{th(j-c)}	Thermal resistance	Junction to case * ²	—	—	4.1	°C/W

*². The contact thermal resistance $R_{th(c-f)}$ is 0.5°C/W with greased.

*³. If special values of I_{GT} are required, choose at least two items from those listed in the table below. (Example: AB, BC)

Item	A	B	C
I _{GT} (μA)	1 ~ 30	20 ~ 50	40 ~ 100

The above values do not include the current flowing through the 220Ω resistance between the gate and cathode.

PERFORMANCE CURVES

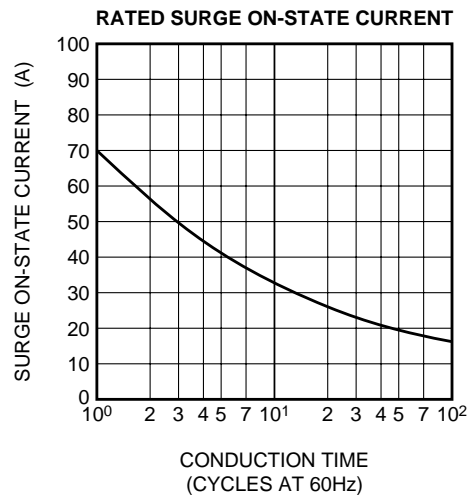
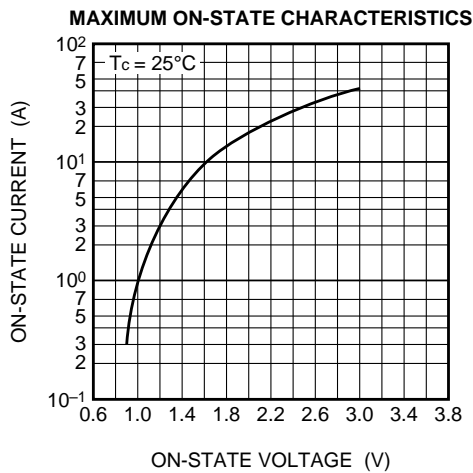

CR3PM

LOW POWER USE
INSULATED TYPE, GLASS PASSIVATION TYPE

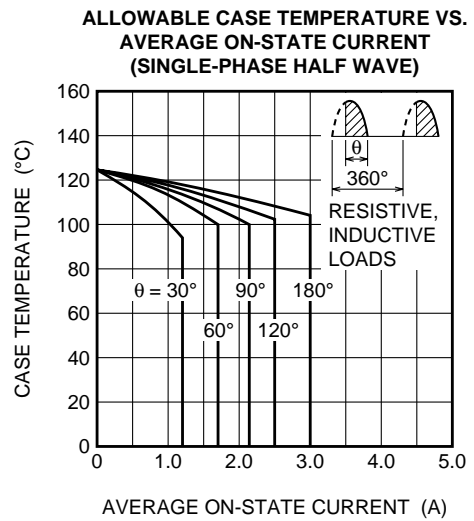
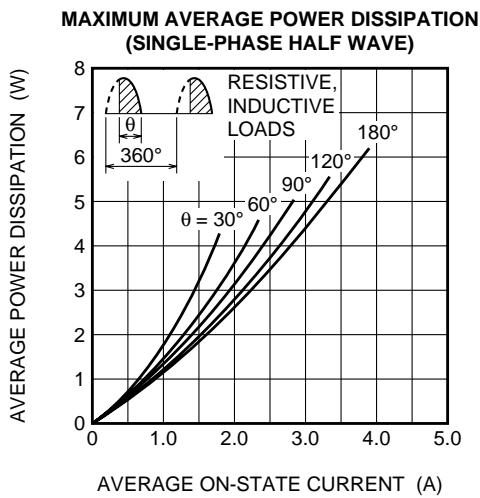
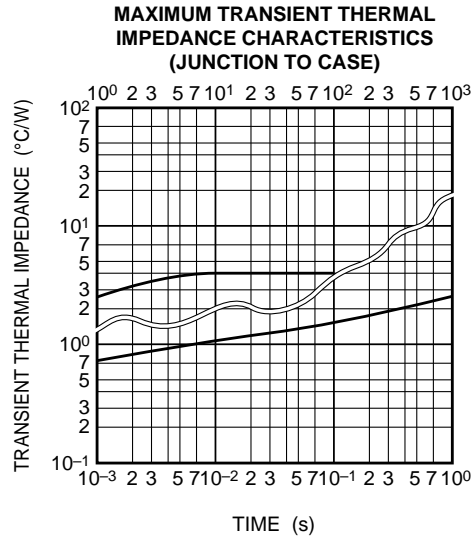
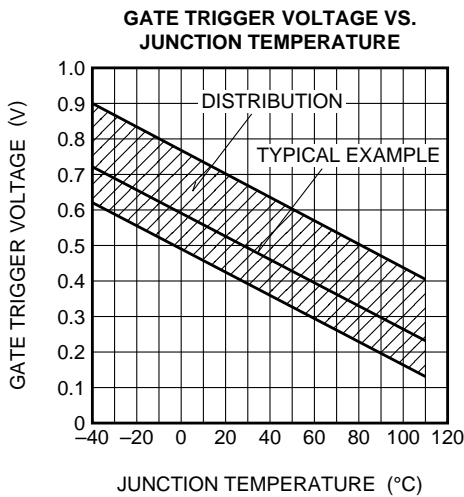
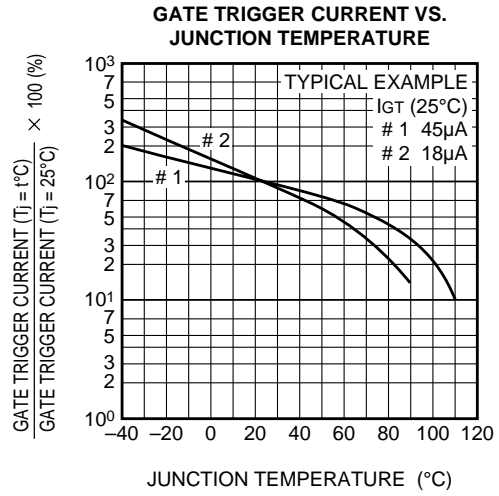
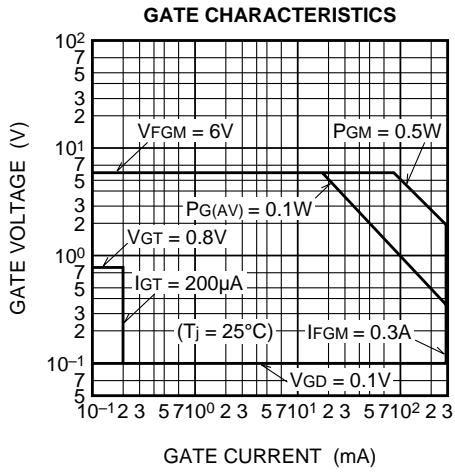

CR3PM

LOW POWER USE
INSULATED TYPE, GLASS PASSIVATION TYPE

ALLOWABLE AMBIENT TEMPERATURE VS. AVERAGE ON-STATE CURRENT (SINGLE-PHASE HALF WAVE)

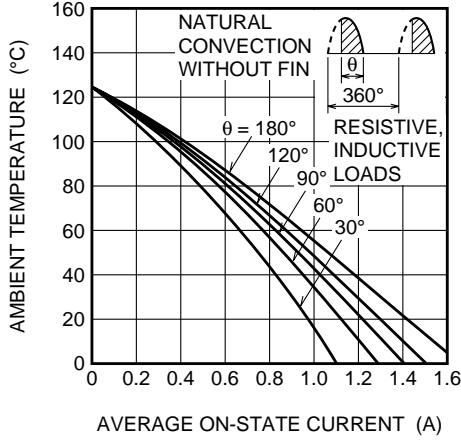

MAXIMUM AVERAGE POWER DISSIPATION (SINGLE-PHASE FULL WAVE)

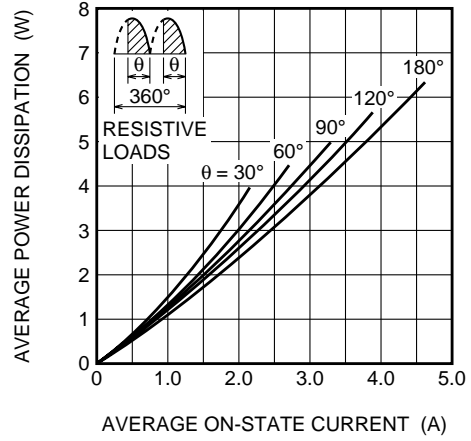

ALLOWABLE CASE TEMPERATURE VS. AVERAGE ON-STATE CURRENT (SINGLE-PHASE FULL WAVE)

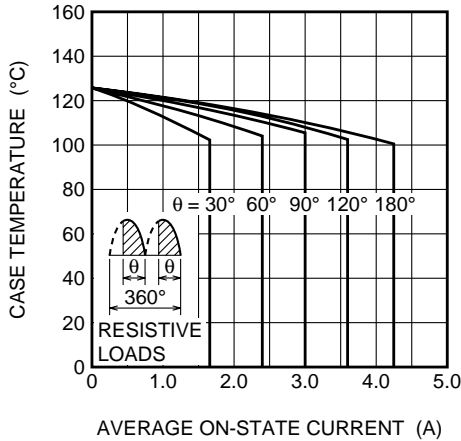

ALLOWABLE AMBIENT TEMPERATURE VS. AVERAGE ON-STATE CURRENT (SINGLE-PHASE FULL WAVE)

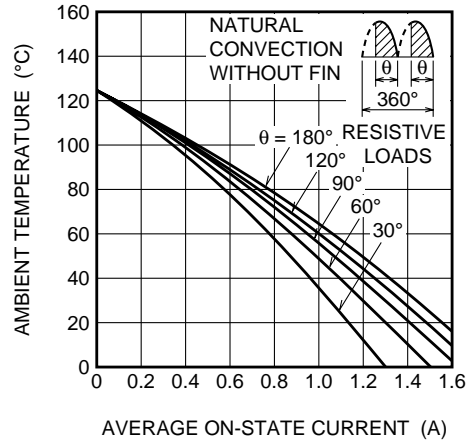

BREAKOVER VOLTAGE VS. JUNCTION TEMPERATURE

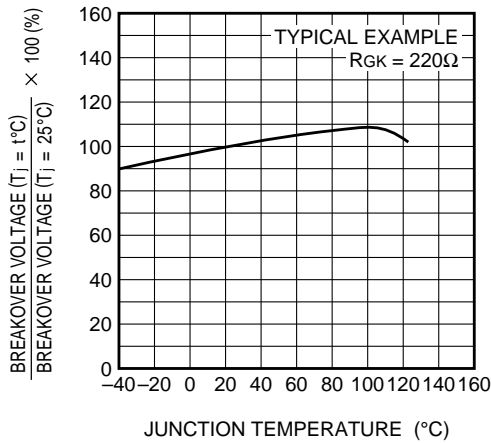

HOLDING CURRENT VS. JUNCTION TEMPERATURE

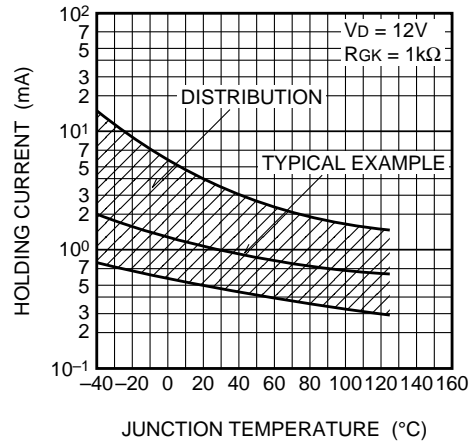

CR3PM

LOW POWER USE
INSULATED TYPE, GLASS PASSIVATION TYPE

