

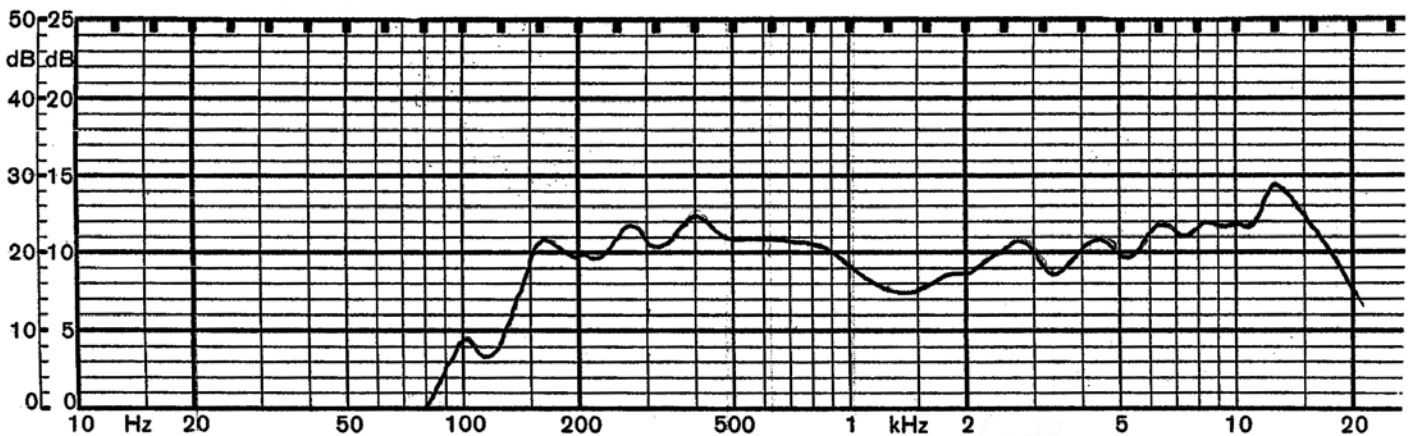

Specifications

Nominal Size	36 x 36 x 14.5 mm	(See attached drawing)
Impedance	8 Ohm \pm 15%	at 1K Hz 1 V
Resonant frequency	230 Hz \pm 46 Hz	at 1 V
Sound pressure level	82 dB/w \pm 3 dB	1 w 50 cm ave. at 0.3K, 0.4K, 0.5K, 0.6KHz
Response	Fo Hz ~ 20 KHz max 10 dB	
Input power	Nominal 2 W	Handling capacity 4 W
Operation	must be normal at program source 2 W	
Buzz, rattle, etc.	must be normal at sine wave 4 V	
Magnet	Size: 18.7 x 4.0 mm	
Load test	White noise 2 W	for 24 hours
Heat test	65 \pm 2° C	20-50% R.H. 24 hours
Humidity test	40 \pm 2° C	90-95% R.H. 24 hours

Frequency Response Curve

Potentiometer range	50 dB
Rectifier	RMS
Lower limit frequency	20 Hz
Wr. speed	100 mm/sec



Zero level 60 dB

REV.	DESCRIPTION	DATE
A	NEW DRAWING	10/2/2006

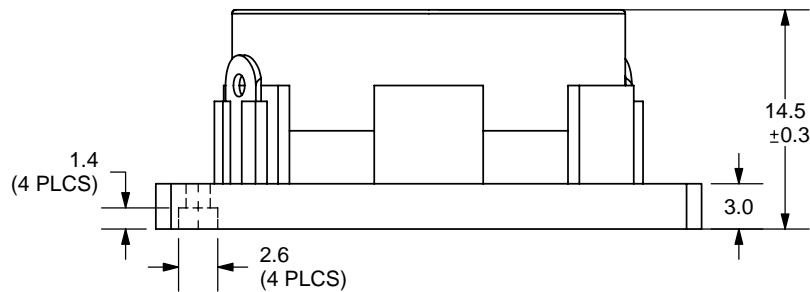
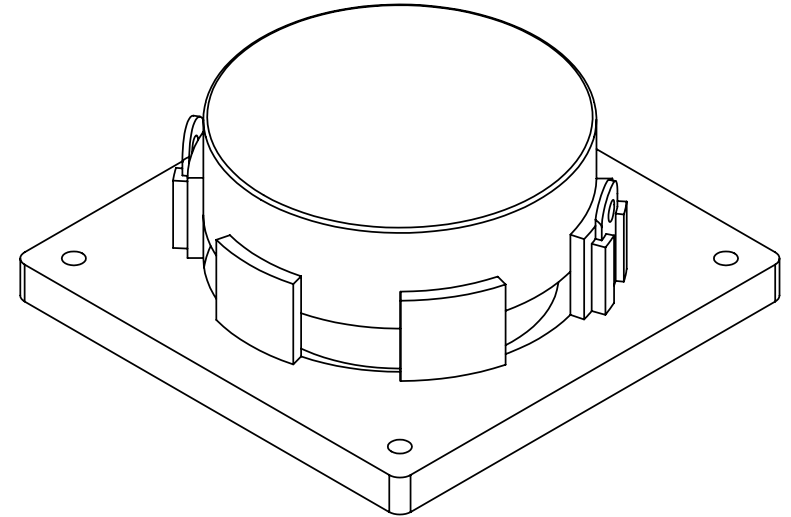
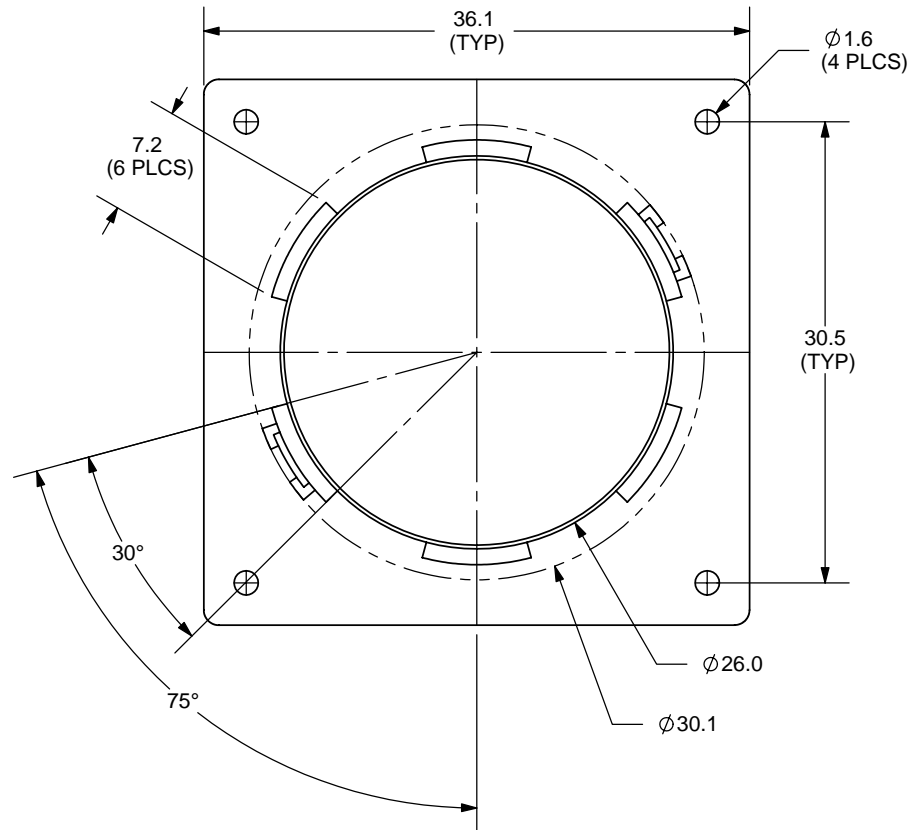

TOLERANCE:
±0.2mm UNLESS OTHERWISE
SPECIFIED



20050 SW 112th Ave.
Tualatin, OR 97062
Phone: 503-643-4899
800-275-4899
Fax: 503-372-1266
Website: www.cui.com

TITLE: MINIATURE MONITOR SPEAKER		REV: A
PART NO. CMS0361KLX		UNITS: MM [INCHES]
DRAWN BY: ZRJ	APPROVED BY:	SCALE: 2:1

PC FILE NAME:
CMS0361KLX

COPYRIGHT 2006 BY CUI INC.