



Micro Commercial Components



Micro Commercial Components
 20736 Marilla Street Chatsworth
 CA 91311
 Phone: (818) 701-4933
 Fax: (818) 701-4939

CMP SH-3/3A/3C/3S

Features

- Low Current Leakage
- For Surface Mount Applications
- Lead Free Finish/RoHS Compliant ("P" Suffix designates RoHS Compliant. See ordering information)
- Epoxy meets UL 94 V-0 flammability rating
- Moisture Sensitivity Level 1

350mW 30Volt Switching Diode

Maximum Ratings

- Operating Temperature: -55°C to +150°C
- Storage Temperature: -55°C to +150°C

SOT-23

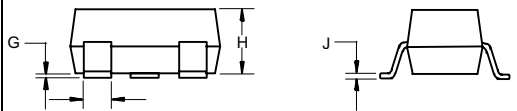
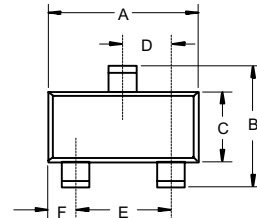

Electrical Characteristics @ 25°C Unless Otherwise Specified

Reverse Voltage	V_R	30V	
Average Rectified Current	I_O	100mA	
Power Dissipation	P_{TOT}	350mW	
Maximum Instantaneous Forward Voltage	V_F	0.33V 0.45V 1.0V	$I_{FM} = 2mA;$ $I_{FM} = 15mA;$ $I_{FM} = 100mA;$
Maximum DC Reverse Current At Rated DC Blocking Voltage	I_R	500nA 100µA	$V_R = 25Volts$ $T_J = 25^\circ C$ $T_J = 100^\circ C$
Typical Junction Capacitance	C_J	4pF	Measured at 1.0MHz, $V_R = 0V$
Reverse Recovery Time	T_{rr}	4nS	$I_F = I_R = 10mA$ $I_{RR} = 1.0mA$ $R_L = 100\Omega$

DIM	INCHES		MM		NOTE
	MIN	MAX	MIN	MAX	
A	.110	.120	2.80	3.04	
B	.083	.098	2.10	2.64	
C	.047	.055	1.20	1.40	
D	.035	.041	.89	1.03	
E	.070	.081	1.78	2.05	
F	.018	.024	.45	.60	
G	.0005	.0039	.013	.100	
H	.035	.044	.89	1.12	
J	.003	.007	.085	.180	
K	.015	.020	.37	.51	

Suggested Solder Pad Layout

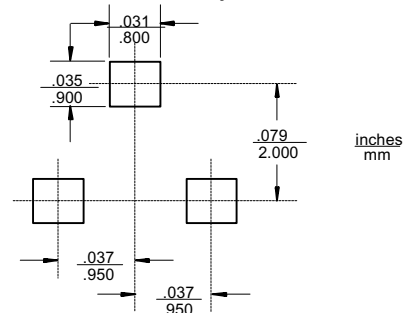

*Pulse test: Pulse width 300 µsec, Duty cycle 2%

CMP SH-3/3A/3C/3S

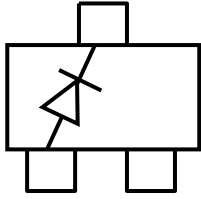

CMP SH-3 Marking: D95

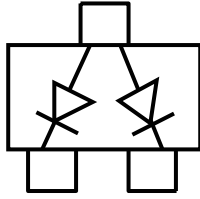

CMP SH-3A Marking: DB1

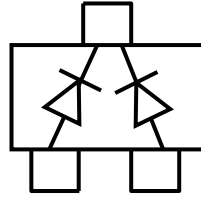

CMP SH-3C Marking: DB2

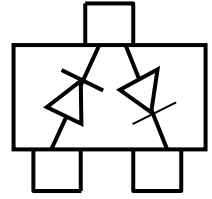

CMP SH-3S Marking: DA5



Micro Commercial Components

Ordering Information :

Device	Packing
Part Number-TP	Tape&Reel: 3Kpcs/Reel

*****IMPORTANT NOTICE*****

Micro Commercial Components Corp. reserves the right to make changes without further notice to any product herein to make corrections, modifications , enhancements , improvements , or other changes . **Micro Commercial Components Corp .** does not assume any liability arising out of the application or use of any product described herein; neither does it convey any license under its patent rights ,nor the rights of others . The user of products in such applications shall assume all risks of such use and will agree to hold **Micro Commercial Components Corp .** and all the companies whose products are represented on our website, harmless against all damages.

*****LIFE SUPPORT*****

MCC's products are not authorized for use as critical components in life support devices or systems without the express written approval of Micro Commercial Components Corporation.

*****CUSTOMER AWARENESS*****

Counterfeiting of semiconductor parts is a growing problem in the industry. Micro Commercial Components (MCC) is taking strong measures to protect ourselves and our customers from the proliferation of counterfeit parts. MCC strongly encourages customers to purchase MCC parts either directly from MCC or from Authorized MCC Distributors who are listed by country on our web page cited below. Products customers buy either from MCC directly or from Authorized MCC Distributors are genuine parts, have full traceability, meet MCC's quality standards for handling and storage. **MCC will not provide any warranty coverage or other assistance for parts bought from Unauthorized Sources.** MCC is committed to combat this global problem and encourage our customers to do their part in stopping this practice by buying direct or from authorized distributors.