

### Mega Power Dual™ IGBTMOD 900 Amperes/1200 Volts

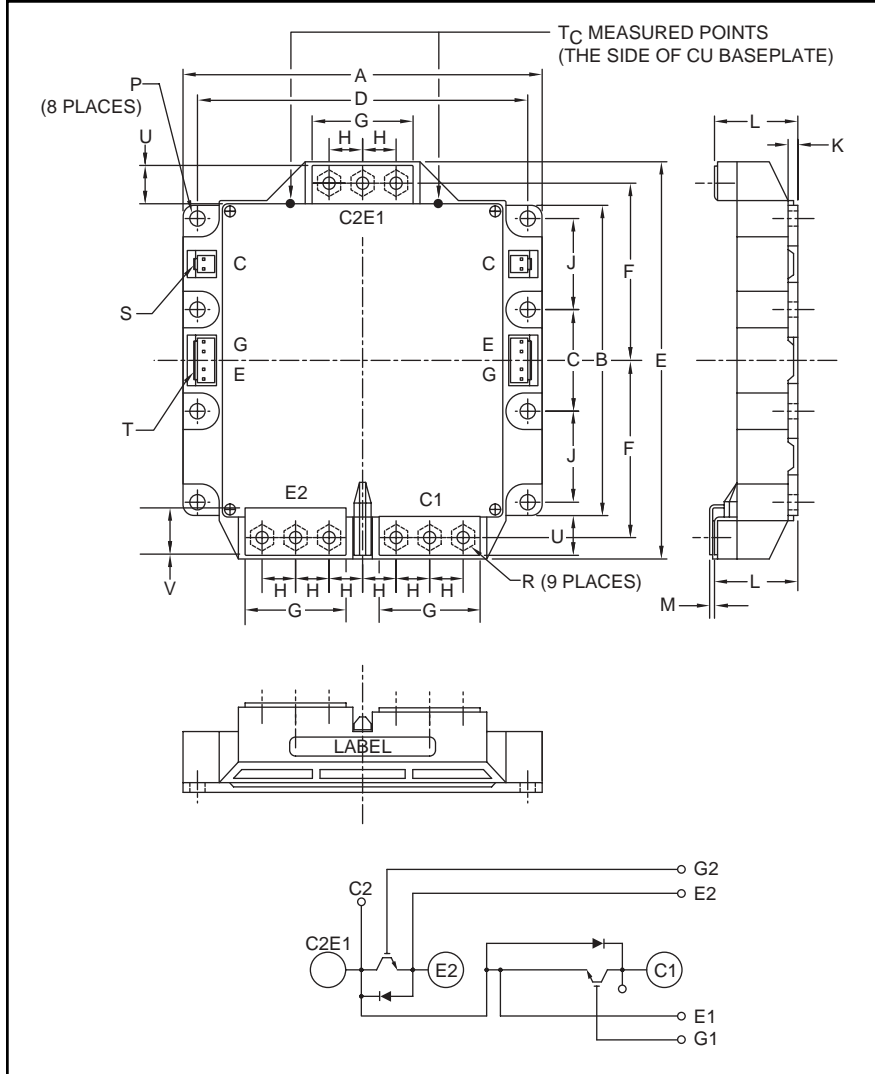

Outline Drawing and Circuit Diagram

Dimensions	Inches	Millimeters
A	5.91	150.0
B	5.10	129.5
C	1.67±0.01	42.5±0.25
D	5.41±0.01	137.5±0.25
E	6.54	166.0
F	2.91±0.01	74.0±0.25
G	1.65	42.0
H	0.55	14.0

Dimensions	Inches	Millimeters
J	1.50±0.01	38.0±0.25
K	0.16	4.0
L	1.36 +0.04/-0.02	34.6 +1.0/-0.5
M	0.075±0.08	1.9±0.2
P	0.26	6.5
R	M6 Metric	M6
U	0.62	15.7
V	0.71	18.0

**Housing Type (J.S.T MFG. CO. ①D)**

S = VHR-2N  
T = VHR-5N



**Description:**

Powerex IGBTMOD™ Modules are designed for use in switching applications. Each module consists of two IGBT Transistors in a half-bridge configuration with each transistor having a reverse-connected super-fast recovery free-wheel diode. All components and interconnects are isolated from the heat sinking baseplate, offering simplified system assembly and thermal management.

**Features:**

- Low Drive Power
- Low  $V_{CE(sat)}$
- Discrete Super-Fast Recovery Free-Wheel Diode
- Isolated Baseplate for Easy Heat Sinking

**Applications:**

- High Power UPS
- Large Motor Drives
- Utility Interface Inverters

**Ordering Information:**

Example: Select the complete module number you desire from the table - i.e. CM900DU-24NF is a 1200V ( $V_{CES}$ ), 900 Ampere Dual IGBTMOD Power Module.

Type	Current Rating Amperes	$V_{CES}$ Volts (x 50)
CM	900	24



Powerex, Inc., 200 E. Hillis Street, Youngwood, Pennsylvania 15697-1800 (724) 925-7272

**CM900DU-24NF**  
**Mega Power Dual™ IGBTMOD**  
 900 Amperes/1200 Volts

**Absolute Maximum Ratings,  $T_j = 25^\circ\text{C}$  unless otherwise specified**

Ratings	Symbol	CM900DU-24NF	Units
Junction Temperature	$T_j$	-40 to 150	$^\circ\text{C}$
Storage Temperature	$T_{stg}$	-40 to 125	$^\circ\text{C}$
Collector-Emitter Voltage (G-E SHORT)	$V_{CES}$	1200	Volts
Gate-Emitter Voltage (C-E SHORT)	$V_{GES}$	$\pm 20$	Volts
Collector Current ( $T_C = 25^\circ\text{C}$ )	$I_C$	900	Amperes
Peak Collector Current ( $T_j \leq 150^\circ\text{C}$ )	$I_{CM}$	1800*	Amperes
Emitter Current ( $T_C = 25^\circ\text{C}$ )**	$I_E$	900	Amperes
Peak Emitter Current**	$I_{EM}$	1800*	Amperes
Maximum Collector Dissipation ( $T_j < 150^\circ\text{C}$ ) ( $T_C = 25^\circ\text{C}$ )	$P_C$	5950	Watts
Mounting Torque, M6 Mounting Screws	-	40	in-lb
Mounting Torque, M6 Main Terminal Screw	-	40	in-lb
Weight (Typical)	-	1400	Grams
Isolation Voltage (Main Terminal to Baseplate, AC 1 min.)	$V_{iso}$	2500	Volts

**Static Electrical Characteristics,  $T_j = 25^\circ\text{C}$  unless otherwise specified**

Characteristics	Symbol	Test Conditions	Min.	Typ.	Max.	Units
Collector-Cutoff Current	$I_{CES}$	$V_{CE} = V_{CES}, V_{GE} = 0V$	-	-	1	mA
Gate Leakage Current	$I_{GES}$	$V_{GE} = V_{GES}, V_{CE} = 0V$	-	-	0.5	$\mu\text{A}$
Gate-Emitter Threshold Voltage	$V_{GE(th)}$	$I_C = 90\text{mA}, V_{CE} = 10V$	6	7	8	Volts
Collector-Emitter Saturation Voltage	$V_{CE(sat)}$	$I_C = 900A, V_{GE} = 15V, T_j = 25^\circ\text{C}$	-	1.9	2.5	Volts
(Without Lead Resistance)	(Chip)	$I_C = 900A, V_{GE} = 15V, T_j = 125^\circ\text{C}$	-	2.1	-	Volts
Module Lead Resistance	$R_{(lead)}$	$I_C = 900A, \text{Terminal-chip}$	-	0.143	-	$\text{m}\Omega$
Total Gate Charge	$Q_G$	$V_{CC} = 600V, I_C = 900A, V_{GE} = 15V$	-	4800	-	nC
Emitter-Collector Voltage**	$V_{EC}$	$I_E = 900A, V_{GE} = 0V$	-	-	3.4	Volts

**Dynamic Electrical Characteristics,  $T_j = 25^\circ\text{C}$  unless otherwise specified**

Characteristics	Symbol	Test Conditions	Min.	Typ.	Max.	Units	
Input Capacitance	$C_{ies}$		-	-	140	nF	
Output Capacitance	$C_{oes}$	$V_{CE} = 10V, V_{GE} = 0V$	-	-	16	nF	
Reverse Transfer Capacitance	$C_{res}$		-	-	3	nF	
Inductive	Turn-on Delay Time	$t_{d(on)}$	$V_{CC} = 600V,$	-	-	300	ns
Load	Rise Time	$t_r$	$I_C = 900A, I_E = 900A,$	-	-	200	ns
Switch	Turn-off Delay Time	$t_{d(off)}$	$V_{GE1} = V_{GE2} = 15V,$	-	-	800	ns
Times	Fall Time	$t_f$	$R_G = 1.0\Omega,$	-	-	300	ns
Diode Reverse Recovery Time**	$t_{rr}$		Inductive Load	-	-	500	ns
Diode Reverse Recovery Charge**	$Q_{rr}$		Switching Operation	-	50	-	$\mu\text{C}$

\* Pulse width and repetition rate should be such that the device junction temperature ( $T_j$ ) does not exceed  $T_{j(max)}$  rating.  
 \*\*Represents characteristics of the anti-parallel, emitter-to-collector free-wheel diode (FWDi).



Powerex, Inc., 200 E. Hillis Street, Youngwood, Pennsylvania 15697-1800 (724) 925-7272

**CM900DU-24NF**  
**Mega Power Dual™ IGBTMOD**  
 900 Amperes/1200 Volts

**Thermal and Mechanical Characteristics,  $T_j = 25^\circ\text{C}$  unless otherwise specified**

Characteristics	Symbol	Test Conditions	Min.	Typ.	Max.	Units
Thermal Resistance, Junction to Case	$R_{th(j-c)Q}$	Per IGBT 1/2 Module, $T_C$ Reference Point Under Chip	–	–	0.021	$^\circ\text{C/W}$
Thermal Resistance, Junction to Case	$R_{th(j-c)D}$	Per FWDi 1/2 Module, $T_C$ Reference $T_C$ Reference Point Under Chip	–	–	0.034	$^\circ\text{C/W}$
Contact Thermal Resistance	$R_{th(c-f)}$	Per 1/2 Module, Thermal Grease Applied	–	0.016	–	$^\circ\text{C/W}$

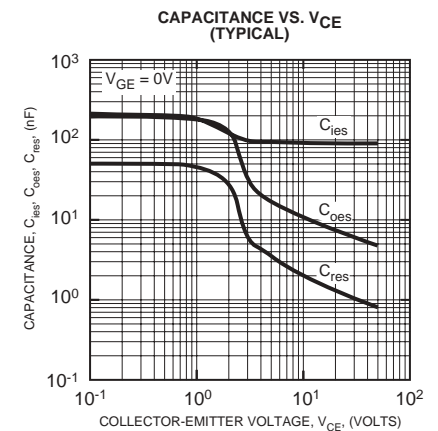
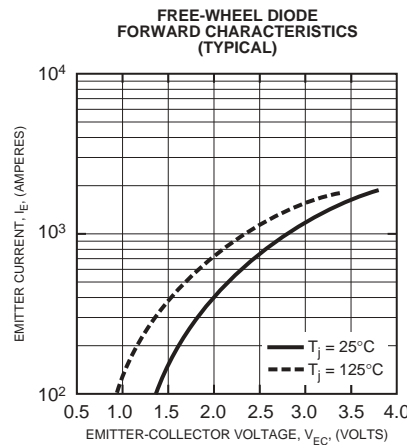
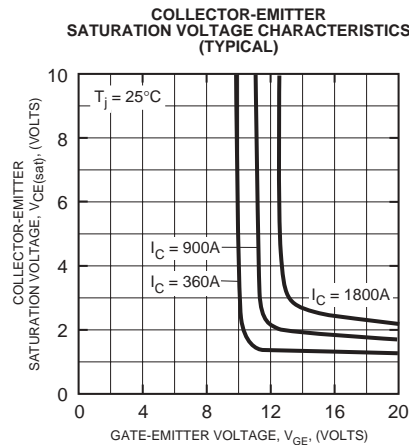
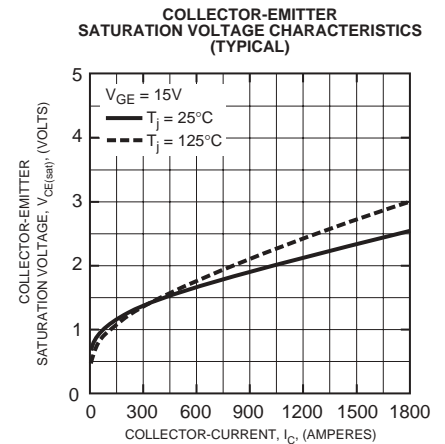
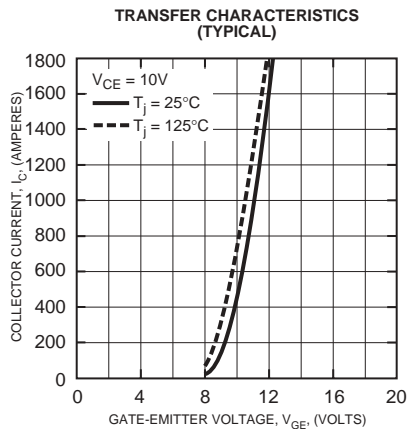
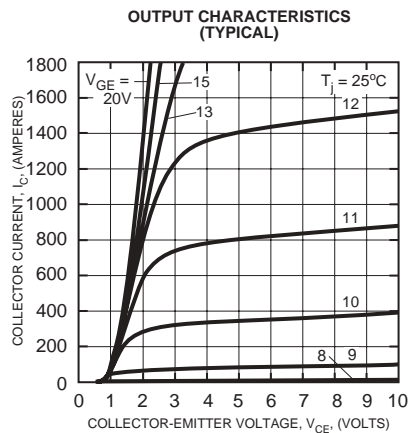



Powerex, Inc., 200 E. Hillis Street, Youngwood, Pennsylvania 15697-1800 (724) 925-7272

**CM900DU-24NF**  
**Mega Power Dual™ IGBTMOD**  
 900 Amperes/1200 Volts

