

Dual IGBTMOD™ H-Series Module 50 Amperes/1200 Volts

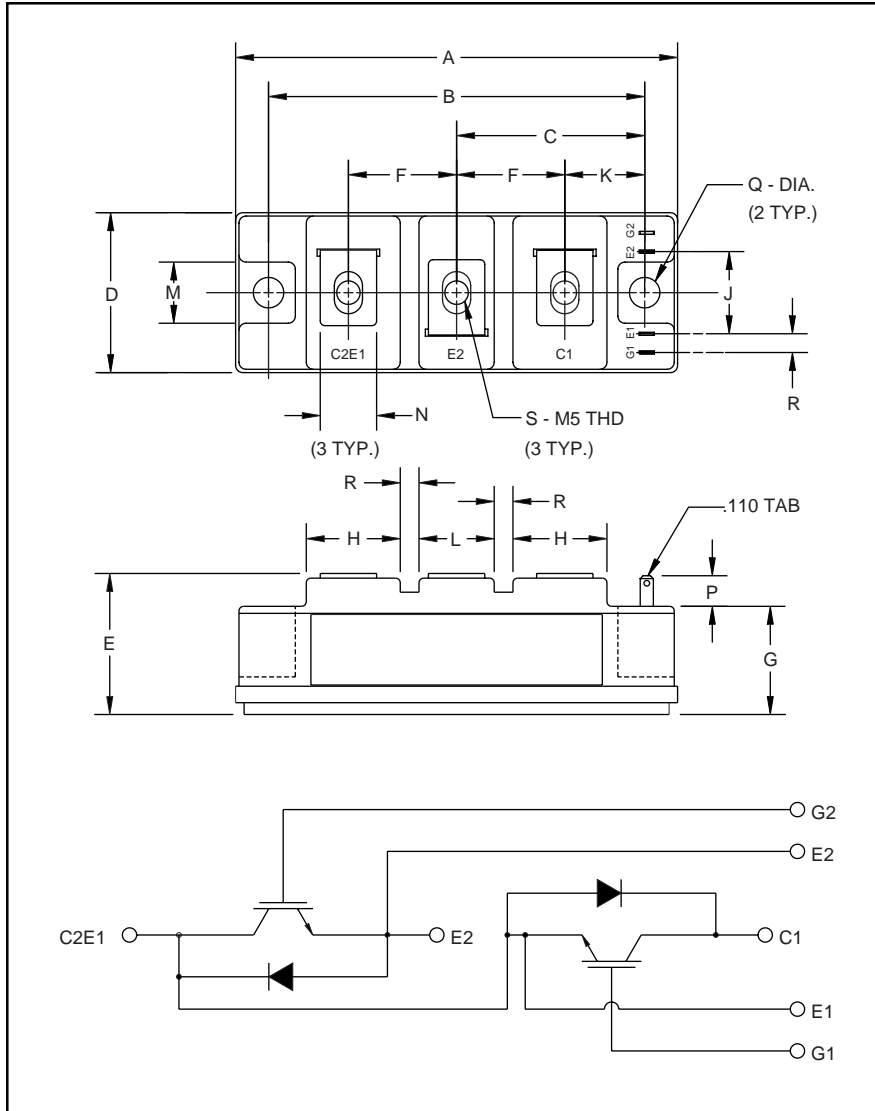

Outline Drawing and Circuit Diagram

Dimensions	Inches	Millimeters
A	3.70	94.0
B	3.150±0.01	80.0±0.25
C	1.57	40.0
D	1.34	34.0
E	1.22 Max.	31.0 Max.
F	0.90	23.0
G	0.85	21.5
H	0.79	20.0
J	0.71	18.0

Dimensions	Inches	Millimeters
K	0.67	17.0
L	0.63	16.0
M	0.51	13.0
N	0.47	12.0
P	0.28	7.0
Q	0.256 Dia.	Dia. 6.5
R	0.16	4.0
S	M5 Metric	M5



Description:

Powerex IGBTMOD™ Modules are designed for use in switching applications. Each module consists of two IGBT transistors in a half-bridge configuration with each transistor having a reverse-connected super-fast recovery free-wheel diode. All components and interconnects are isolated from the heat sinking baseplate, offering simplified system assembly and thermal management.

Features:

- Low Drive Power
- Low $V_{CE(sat)}$
- Discrete Super-Fast Recovery (135ns) Free-Wheel Diode
- High Frequency Operation (20-25kHz)
- Isolated Baseplate for Easy Heat Sinking

Applications:

- AC Motor Control
- Motion/Servo Control
- UPS
- Welding Power Supplies
- Laser Power Supplies

Ordering Information:

Example: Select the complete part module number you desire from the table below -i.e. CM50DY-24H is a 1200V (V_{CES}), 50 Ampere Dual IGBTMOD™ Power Module.

Type	Current Rating Amperes	V_{CES} Volts (x 50)
CM	50	24

CM50DY-24H
Dual IGBTMOD™ H-Series Module
 50 Amperes/1200 Volts

Absolute Maximum Ratings, $T_j = 25\text{ }^\circ\text{C}$ unless otherwise specified

Ratings	Symbol	CM50DY-24H	Units
Junction Temperature	T_j	-40 to 150	$^\circ\text{C}$
Storage Temperature	T_{stg}	-40 to 125	$^\circ\text{C}$
Collector-Emitter Voltage (G-E SHORT)	V_{CES}	1200	Volts
Gate-Emitter Voltage	V_{GES}	± 20	Volts
Collector Current	I_C	50	Amperes
Peak Collector Current	I_{CM}	100*	Amperes
Diode Forward Current	I_F	50	Amperes
Diode Forward Surge Current	I_{FM}	100*	Amperes
Power Dissipation	P_d	400	Watts
Max. Mounting Torque M5 Terminal Screws	–	17	in-lb
Max. Mounting Torque M6 Mounting Screws	–	26	in-lb
Module Weight (Typical)	–	190	Grams
V Isolation	V_{RMS}	2500	Volts

* Pulse width and repetition rate should be such that device junction temperature does not exceed the device rating.

Static Electrical Characteristics, $T_j = 25\text{ }^\circ\text{C}$ unless otherwise specified

Characteristics	Symbol	Test Conditions	Min.	Typ.	Max.	Units
Collector-Cutoff Current	I_{CES}	$V_{\text{CE}} = V_{\text{CES}}, V_{\text{GE}} = 0\text{V}$	–	–	1.0	mA
Gate Leakage Current	I_{GES}	$V_{\text{GE}} = V_{\text{GES}}, V_{\text{CE}} = 0\text{V}$	–	–	0.5	μA
Gate-Emitter Threshold Voltage	$V_{\text{GE(th)}}$	$I_C = 5\text{mA}, V_{\text{CE}} = 10\text{V}$	4.5	6.0	7.5	Volts
Collector-Emitter Saturation Voltage	$V_{\text{CE(sat)}}$	$I_C = 50\text{A}, V_{\text{GE}} = 15\text{V}$	–	2.5	3.4**	Volts
		$I_C = 50\text{A}, V_{\text{GE}} = 15\text{V}, T_j = 150^\circ\text{C}$	–	2.25	–	Volts
Total Gate Charge	Q_G	$V_{\text{CC}} = 600\text{V}, I_C = 50\text{A}, V_{\text{GS}} = 15\text{V}$	–	250	–	nC
Diode Forward Voltage	V_{FM}	$I_E = 50\text{A}, V_{\text{GS}} = 0\text{V}$	–	–	3.5	Volts

** Pulse width and repetition rate should be such that device junction temperature rise is negligible.

Dynamic Electrical Characteristics, $T_j = 25\text{ }^\circ\text{C}$ unless otherwise specified

Characteristics	Symbol	Test Conditions	Min.	Typ.	Max.	Units
Input Capacitance	C_{ies}		–	–	10	nF
Output Capacitance	C_{Oes}	$V_{\text{GE}} = 0\text{V}, V_{\text{CE}} = 10\text{V}, f = 1\text{MHz}$	–	–	3.5	nF
Reverse Transfer Capacitance	C_{res}		–	–	2	nF
Resistive	Turn-on Delay Time	$V_{\text{CC}} = 600\text{V}, I_C = 50\text{A},$	–	–	80	ns
Load	Rise Time					
Switching	Turn-off Delay Time	$V_{\text{GE1}} = V_{\text{GE2}} = 15\text{V}, R_G = 6.3\Omega$	–	–	150	ns
	Times					
Diode Reverse Recovery Time	t_{rr}	$I_E = 50\text{A}, di_E/dt = -100\text{A}/\mu\text{s}$	–	–	250	ns
Diode Reverse Recovery Charge	Q_{rr}	$I_E = 50\text{A}, di_E/dt = -100\text{A}/\mu\text{s}$	–	0.37	–	μC

Thermal and Mechanical Characteristics, $T_j = 25\text{ }^\circ\text{C}$ unless otherwise specified

Characteristics	Symbol	Test Conditions	Min.	Typ.	Max.	Units
Thermal Resistance, Junction to Case	$R_{\text{th(j-c)}}$	Per IGBT	–	–	0.31	$^\circ\text{C}/\text{W}$
Thermal Resistance, Junction to Case	$R_{\text{th(j-c)}}$	Per FWDi	–	–	0.70	$^\circ\text{C}/\text{W}$
Contact Thermal Resistance	$R_{\text{th(c-f)}}$	Per Module, Thermal Grease Applied	–	–	0.075	$^\circ\text{C}/\text{W}$



Powerex, Inc., 200 Hillis Street, Youngwood, Pennsylvania 15697-1800 (724) 925-7272

CM50DY-24H
Dual IGBTMOD™ H-Series Module
 50 Amperes/1200 Volts

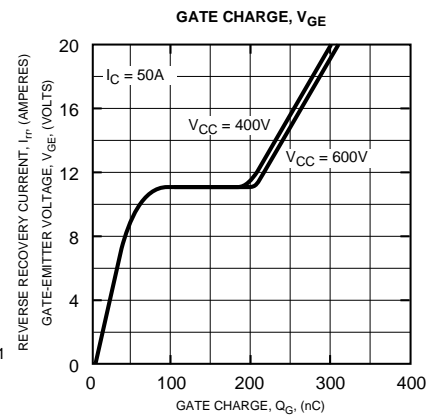
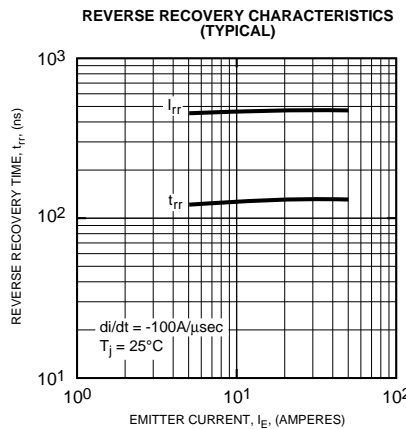
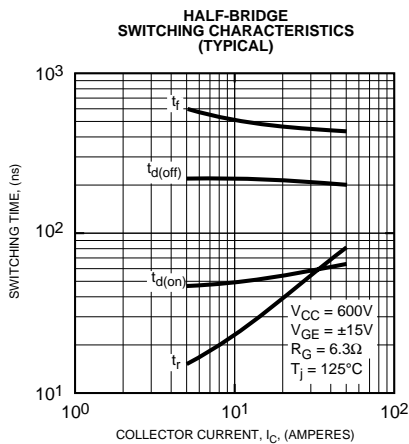
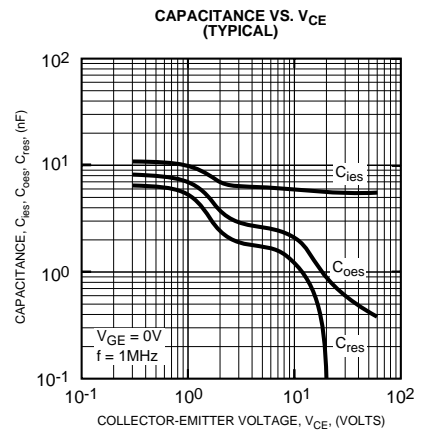
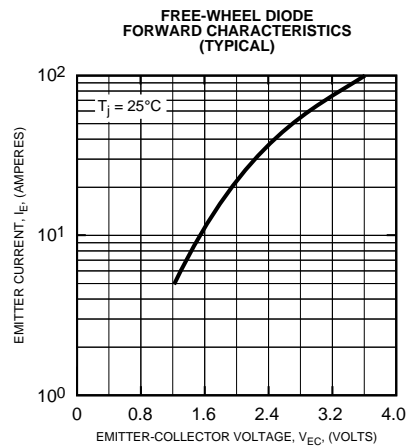
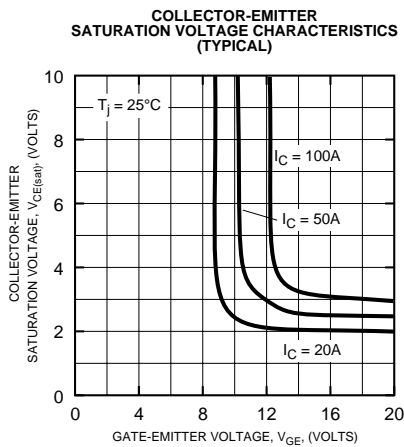
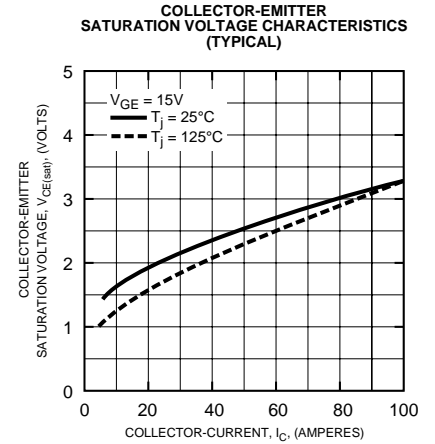
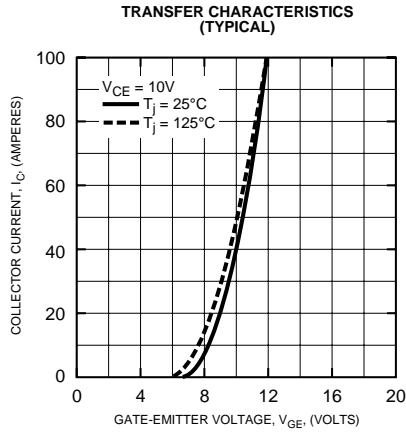
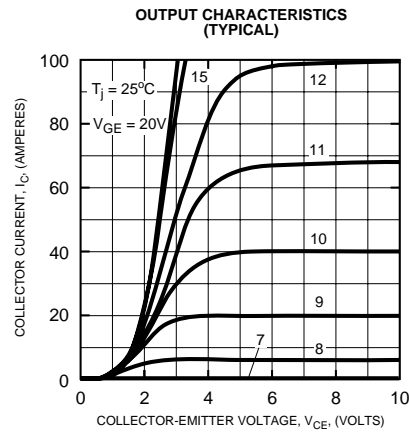

CM50DY-24H
Dual IGBTMOD™ H-Series Module
 50 Amperes/1200 Volts

