

Dual IGBTMOD™ U-Series Module 50 Amperes/1200 Volts

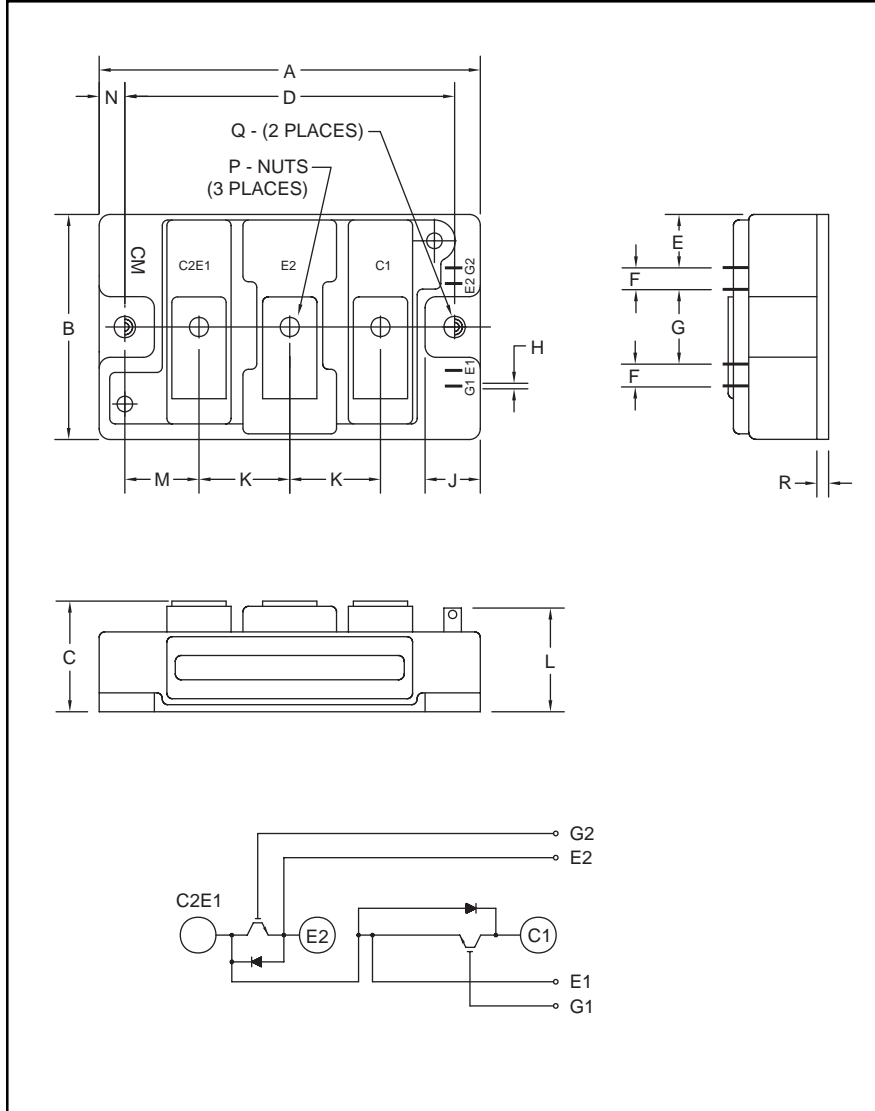

Outline Drawing and Circuit Diagram

Dimensions	Inches	Millimeters
A	3.7	94.0
B	1.89	48.0
C	1.18 +0.04/-0.02	30.0 +1.0/-0.5
D	3.15±0.01	80.0±0.25
E	0.43	11.0
F	0.16	4.0
G	0.71	18.0
H	0.02	0.5

Dimensions	Inches	Millimeters
J	0.53	13.5
K	0.91	23.0
L	1.13	28.7
M	0.67	17.0
N	0.28	7.0
P	M5	M5
Q	0.26 Dia.	6.5 Dia.
R	0.02	4.0



Description:

Powerex IGBTMOD™ Modules are designed for use in switching applications. Each module consists of two IGBT Transistors in a half-bridge configuration with each transistor having a reverse-connected super-fast recovery free-wheel diode. All components and interconnects are isolated from the heat sinking baseplate, offering simplified system assembly and thermal management.

Features:

- Low Drive Power
- Low $V_{CE(sat)}$
- Discrete Super-Fast Recovery Free-Wheel Diode
- Isolated Baseplate for Easy Heat Sinking

Applications:

- AC Motor Control
- Motion/Servo Control
- UPS
- Welding Power Supplies
- Laser Power Supplies

Ordering Information:

Example: Select the complete module number you desire from the table - i.e. CM50DU-24H is a 1200V (V_{CES}), 50 Ampere Dual IGBTMOD™ Power Module.

Type	Current Rating Amperes	V_{CES} Volts (x 50)
CM	50	24

CM50DU-24H
Dual IGBTMOD™ U-Series Module
 50 Amperes/1200 Volts

Absolute Maximum Ratings, $T_j = 25\text{ }^\circ\text{C}$ unless otherwise specified

Ratings	Symbol	CM50DU-24H	Units
Junction Temperature	T_j	-40 to 150	$^\circ\text{C}$
Storage Temperature	T_{stg}	-40 to 125	$^\circ\text{C}$
Collector-Emitter Voltage (G-E SHORT)	V_{CES}	1200	Volts
Gate-Emitter Voltage (C-E SHORT)	V_{GES}	± 20	Volts
Collector Current ($T_c = 25^\circ\text{C}$)	I_C	50	Amperes
Peak Collector Current	I_{CM}	100*	Amperes
Emitter Current** ($T_c = 25^\circ\text{C}$)	I_E	50	Amperes
Peak Emitter Current**	I_{EM}	100*	Amperes
Maximum Collector Dissipation ($T_c = 25^\circ\text{C}$, $T_j \leq 150^\circ\text{C}$)	P_C	400	Watts
Mounting Torque, M5 Main Terminal	–	31	in-lb
Mounting Torque, M6 Mounting	–	40	in-lb
Weight	–	310	Grams
Isolation Voltage (Main Terminal to Baseplate, AC 1 min.)	V_{iso}	2500	Volts

* Pulse width and repetition rate should be such that the device junction temperature (T_j) does not exceed $T_{j(max)}$ rating.

**Represents characteristics of the anti-parallel, emitter-to-collector free-wheel diode (FWDi).

Static Electrical Characteristics, $T_j = 25\text{ }^\circ\text{C}$ unless otherwise specified

Characteristics	Symbol	Test Conditions	Min.	Typ.	Max.	Units
Collector-Cutoff Current	I_{CES}	$V_{CE} = V_{CES}$, $V_{GE} = 0V$	–	–	1	mA
Gate Leakage Voltage	I_{GES}	$V_{GE} = V_{GES}$, $V_{CE} = 0V$	–	–	0.5	μA
Gate-Emitter Threshold Voltage	$V_{GE(th)}$	$I_C = 5\text{mA}$, $V_{CE} = 10V$	4.5	6	7.5	Volts
Collector-Emitter Saturation Voltage	$V_{CE(sat)}$	$I_C = 50\text{A}$, $V_{GE} = 15V$, $T_j = 25^\circ\text{C}$	–	2.9	3.7	Volts
		$I_C = 50\text{A}$, $V_{GE} = 15V$, $T_j = 125^\circ\text{C}$	–	2.85	–	Volts
Total Gate Charge	Q_G	$V_{CC} = 600V$, $I_C = 50\text{A}$, $V_{GE} = 15V$	–	187	–	nC
Emitter-Collector Voltage**	V_{EC}	$I_E = 50\text{A}$, $V_{GE} = 0V$	–	–	3.2	Volts

**Represents characteristics of the anti-parallel, emitter-to-collector free-wheel diode (FWDi).

Dynamic Electrical Characteristics, $T_j = 25\text{ }^\circ\text{C}$ unless otherwise specified

Characteristics	Symbol	Test Conditions	Min.	Typ.	Max.	Units
Input Capacitance	C_{ies}		–	–	7.5	nf
Output Capacitance	C_{oes}	$V_{CE} = 10V$, $V_{GE} = 0V$	–	–	2.6	nf
Reverse Transfer Capacitance	C_{res}		–	–	1.5	nf
Resistive	Turn-on Delay Time	$V_{CC} = 600V$, $I_C = 50\text{A}$, $V_{GE1} = V_{GE2} = 15V$,	–	–	80	ns
Load	Rise Time		t_r	–	–	200
Switch	Turn-off Delay Time	$R_G = 6.3\Omega$, Resistive Load Switching Operation	–	–	150	ns
Times	Fall Time		t_f	–	–	350
Diode Reverse Recovery Time**	t_{rr}	$I_E = 50\text{A}$, $dI_E/dt = -100\text{A}/\mu\text{s}$	–	–	300	ns
Diode Reverse Recovery Charge**	Q_{rr}	$I_E = 50\text{A}$, $dI_E/dt = -100\text{A}/\mu\text{s}$	–	0.28	–	μC

**Represents characteristics of the anti-parallel, emitter-to-collector free-wheel diode (FWDi).

Thermal and Mechanical Characteristics, $T_j = 25\text{ }^\circ\text{C}$ unless otherwise specified

Characteristics	Symbol	Test Conditions	Min.	Typ.	Max.	Units
Thermal Resistance, Junction to Case	$R_{th(j-c)Q}$	Per IGBT 1/2 Module	–	–	0.31	$^\circ\text{C}/\text{W}$
Thermal Resistance, Junction to Case	$R_{th(j-c)D}$	Per FWDi 1/2 Module	–	–	0.7	$^\circ\text{C}/\text{W}$
Contact Thermal Resistance	$R_{th(c-f)}$	Per Module, Thermal Grease Applied	–	0.035	–	$^\circ\text{C}/\text{W}$

CM50DU-24H
Dual IGBTMOD™ U-Series Module
 50 Amperes/1200 Volts

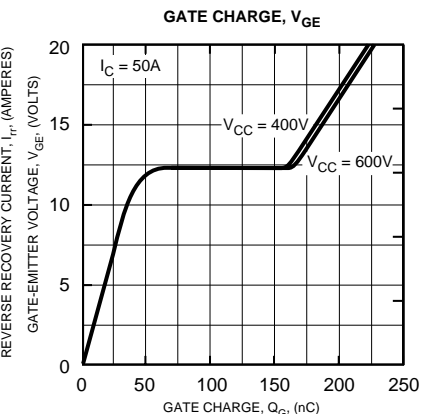
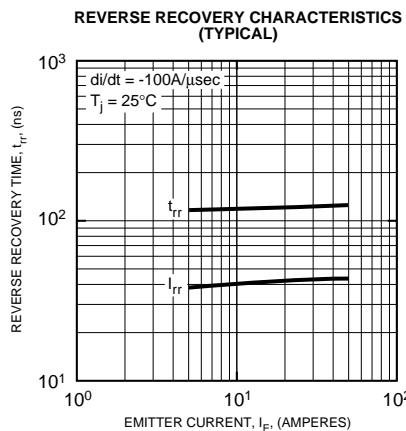
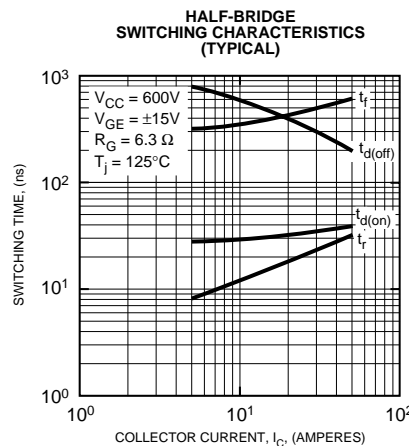
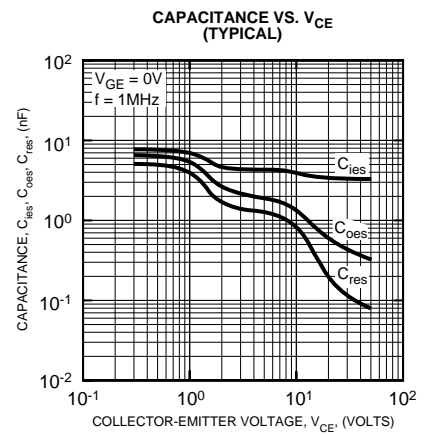
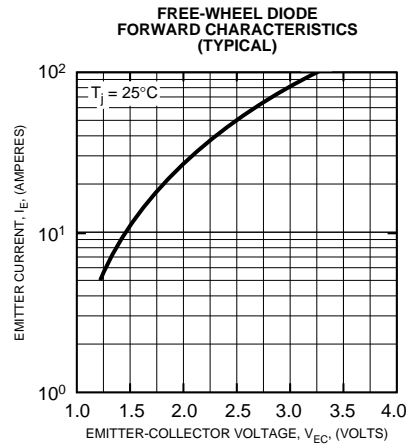
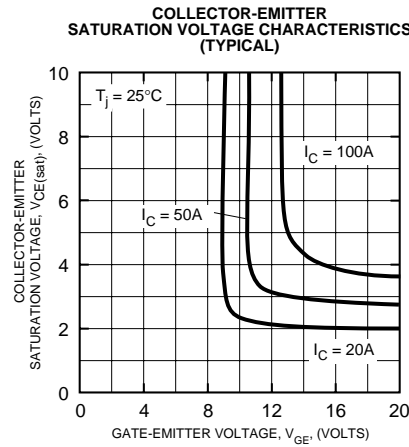
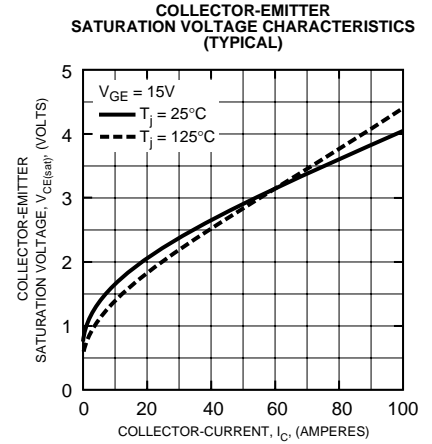
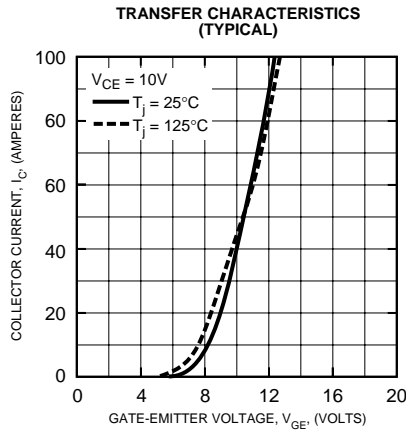
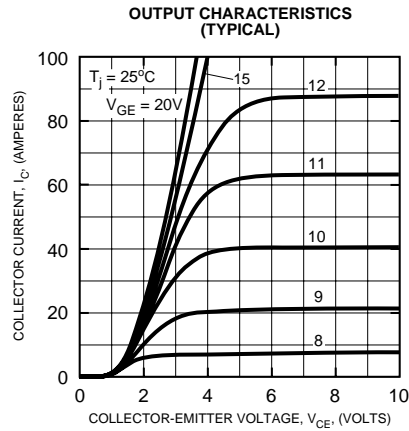

CM50DU-24H
Dual IGBTMOD™ U-Series Module
 50 Amperes/1200 Volts

