

Mega Power Dual™ IGBTMOD 1400 Amperes/1200 Volts

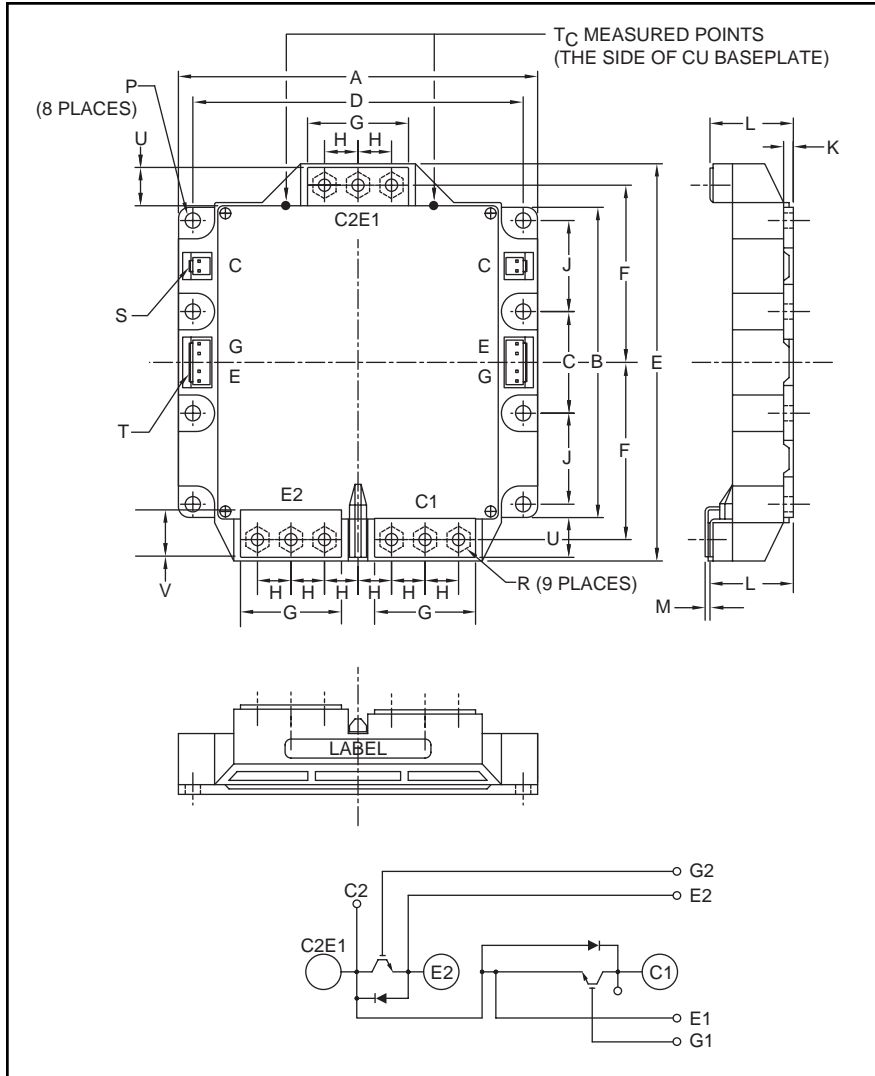

Outline Drawing and Circuit Diagram

Dimensions	Inches	Millimeters
A	5.91	150.0
B	5.10	129.5
C	1.67±0.01	42.5±0.25
D	5.41±0.01	137.5±0.25
E	6.54	166.0
F	2.91±0.01	74.0±0.25
G	1.65	42.0
H	0.55	14.0

Housing Type (J.S.T MFG. CO. □□)

S = VHR-2N
T = VHR-5N

Dimensions	Inches	Millimeters
J	1.50±0.01	38.0±0.25
K	0.16	4.0
L	1.36 +0.04/-0.02	34.6 +1.0/-0.5
M	0.075±0.08	1.9±0.2
P	0.26	6.5
R	M6 Metric	M6
U	0.62	15.7
V	0.71	18.0



Description:

Powerex IGBTMOD™ Modules are designed for use in switching two IGBT applications. Each module consists of a half-bridge configuration, with each transistor having a reverse-connected super-fast recovery free-wheel diode. All components and interconnects are isolated from the heat sinking baseplate, offering simplified system assembly and thermal management.

Features:

- Low Drive Power
- Low V_{CE(sat)}
- Discrete Super-Fast Recovery Free-Wheel Diode
- Isolated Baseplate for Easy Heat Sinking

Applications:

- High Power UPS
- Large Motor Drives
- Utility Interface Inverters

Ordering Information:

Example: Select the complete module number you desire from the table - i.e. CM1400DU-24NF is a 1200V (V_{CEs}), 1400 Ampere Dual IGBTMOD Power Module.

Type	Current Rating Amperes	V _{CEs} Volts (x 50)
CM	1400	24



Powerex, Inc., 200 E. Hillis Street, Youngwood, Pennsylvania 15697-1800 (724) 925-7272

CM1400DU-24NF
Mega Power Dual™ IGBTMOD
 1400 Amperes/1200 Volts

Absolute Maximum Ratings, $T_j = 25^\circ\text{C}$ unless otherwise specified

Ratings	Symbol	CM1400DU-24NF	Units
Junction Temperature	T_j	-40 to 150	$^\circ\text{C}$
Storage Temperature	T_{stg}	-40 to 125	$^\circ\text{C}$
Collector-Emitter Voltage (G-E SHORT)	V_{CES}	1200	Volts
Gate-Emitter Voltage (C-E SHORT)	V_{GES}	± 20	Volts
Collector Current ($T_C = 25^\circ\text{C}$)	I_C	1400	Amperes
Peak Collector Current ($T_j \leq 150^\circ\text{C}$)	I_{CM}	2800*	Amperes
Emitter Current ($T_C = 25^\circ\text{C}$)**	I_E	1400	Amperes
Peak Emitter Current**	I_{EM}	2800*	Amperes
Maximum Collector Dissipation ($T_j < 150^\circ\text{C}$) ($T_C = 25^\circ\text{C}$)	P_C	8920	Watts
Mounting Torque, M6 Mounting Screws	-	40	in-lb
Mounting Torque, M6 Main Terminal Screw	-	40	in-lb
Weight (Typical)	-	1400	Grams
Isolation Voltage (Main Terminal to Baseplate, AC 1 min.)	V_{iso}	2500	Volts

Static Electrical Characteristics, $T_j = 25^\circ\text{C}$ unless otherwise specified

Characteristics	Symbol	Test Conditions	Min.	Typ.	Max.	Units
Collector-Cutoff Current	I_{CES}	$V_{CE} = V_{CES}, V_{GE} = 0V$	-	-	1	mA
Gate Leakage Current	I_{GES}	$V_{GE} = V_{GES}, V_{CE} = 0V$	-	-	0.5	μA
Gate-Emitter Threshold Voltage	$V_{GE(th)}$	$I_C = 140\text{mA}, V_{CE} = 10V$	6	7	8	Volts
Collector-Emitter Saturation Voltage	$V_{CE(sat)}$	$I_C = 1400A, V_{GE} = 15V, T_j = 25^\circ\text{C}$	-	1.9	2.5	Volts
(Without Lead Resistance)	(Chip)	$I_C = 1400A, V_{GE} = 15V, T_j = 125^\circ\text{C}$	-	2.1	-	Volts
Module Lead Resistance	$R_{(lead)}$	$I_C = 1400A, \text{Terminal-chip}$	-	0.143	-	$\text{m}\Omega$
Total Gate Charge	Q_G	$V_{CC} = 600V, I_C = 1400A, V_{GE} = 15V$	-	7200	-	nC
Emitter-Collector Voltage**	V_{EC}	$I_E = 1400A, V_{GE} = 0V$	-	-	3.4	Volts

Dynamic Electrical Characteristics, $T_j = 25^\circ\text{C}$ unless otherwise specified

Characteristics	Symbol	Test Conditions	Min.	Typ.	Max.	Units	
Input Capacitance	C_{ies}		-	-	220	nF	
Output Capacitance	C_{oes}	$V_{CE} = 10V, V_{GE} = 0V$	-	-	25	nF	
Reverse Transfer Capacitance	C_{res}		-	-	4.7	nF	
Inductive	Turn-on Delay Time	$t_{d(on)}$	$V_{CC} = 600V,$	-	-	400	ns
Load	Rise Time	t_r	$I_C = 1400A, I_E = 1400A,$	-	-	300	ns
Switch	Turn-off Delay Time	$t_{d(off)}$	$V_{GE1} = V_{GE2} = 15V,$	-	-	1000	ns
Times	Fall Time	t_f	$R_G = 1.0\Omega,$	-	-	300	ns
Diode Reverse Recovery Time**	t_{rr}		Inductive Load	-	-	800	ns
Diode Reverse Recovery Charge**	Q_{rr}		Switching Operation	-	100	-	μC

* Pulse width and repetition rate should be such that the device junction temperature (T_j) does not exceed $T_{j(max)}$ rating.
 **Represents characteristics of the anti-parallel, emitter-to-collector free-wheel diode (FWDi).



Powerex, Inc., 200 E. Hillis Street, Youngwood, Pennsylvania 15697-1800 (724) 925-7272

CM1400DU-24NF
Mega Power Dual™ IGBTMOD
 1400 Amperes/1200 Volts

Thermal and Mechanical Characteristics, $T_j = 25^\circ\text{C}$ unless otherwise specified

Characteristics	Symbol	Test Conditions	Min.	Typ.	Max.	Units
Thermal Resistance, Junction to Case	$R_{th(j-c)Q}$	Per IGBT 1/2 Module, T_C Reference Point Under Chip	–	–	0.014	$^\circ\text{C/W}$
Thermal Resistance, Junction to Case	$R_{th(j-c)D}$	Per FWDi 1/2 Module, T_C Reference T_C Reference Point Under Chip	–	–	0.023	$^\circ\text{C/W}$
Contact Thermal Resistance	$R_{th(c-f)}$	Per 1/2 Module, Thermal Grease Applied	–	0.016	–	$^\circ\text{C/W}$

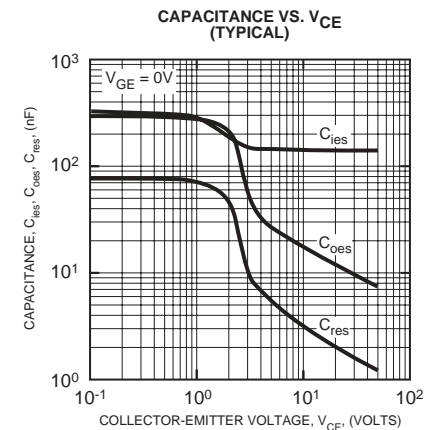
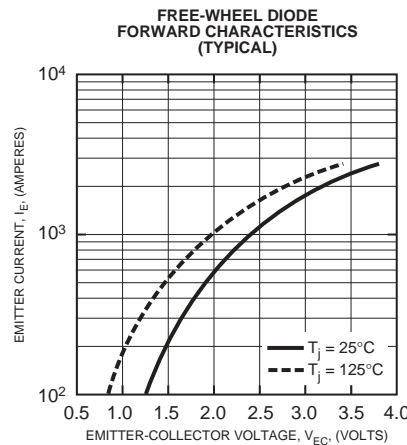
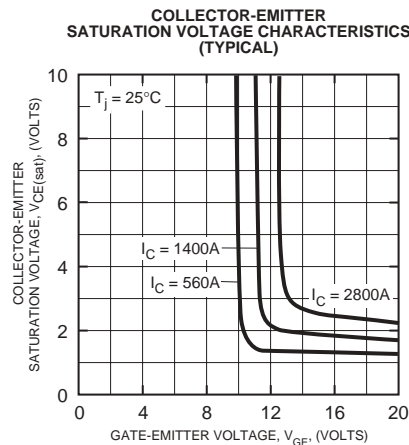
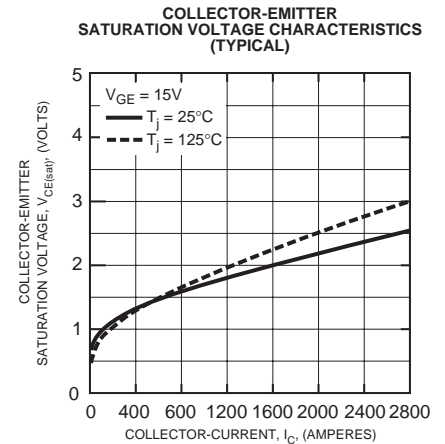
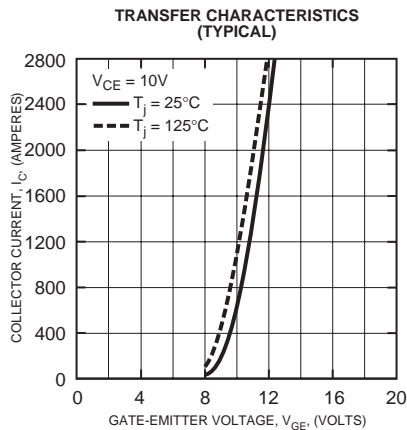
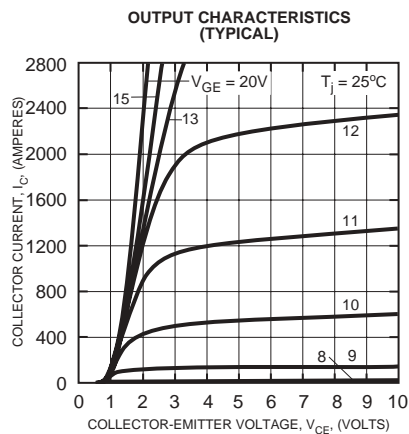



Powerex, Inc., 200 E. Hillis Street, Youngwood, Pennsylvania 15697-1800 (724) 925-7272

CM1400DU-24NF
Mega Power Dual™ IGBTMOD
 1400 Amperes/1200 Volts

HALF-BRIDGE SWITCHING CHARACTERISTICS (TYPICAL)

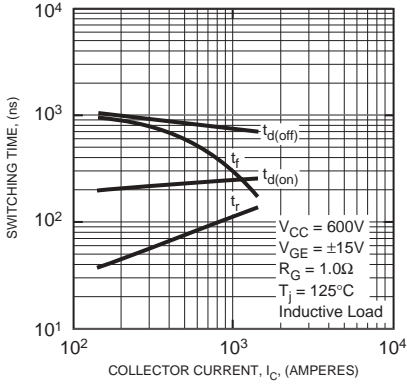

REVERSE RECOVERY CHARACTERISTICS (TYPICAL)

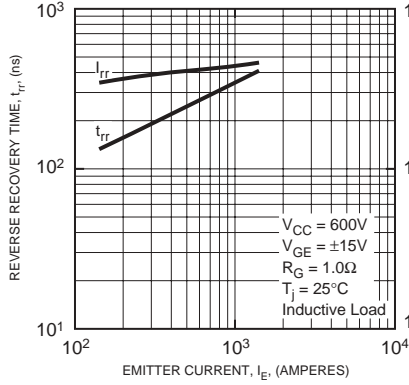

GATE CHARGE, V_GE

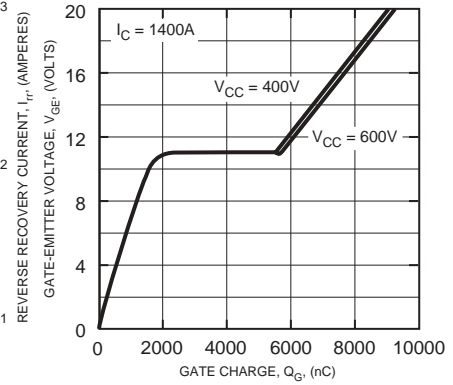

TRANSIENT THERMAL IMPEDANCE CHARACTERISTICS (IGBT & FWDI)

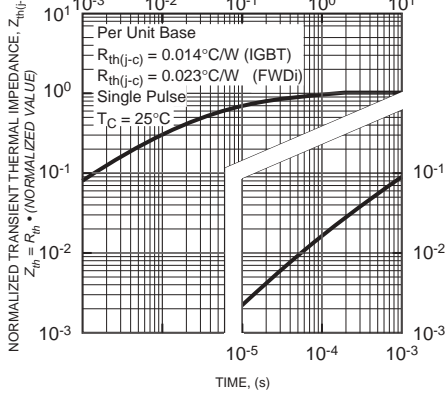

SWITCHING LOSS VS. COLLECTOR CURRENT (TYPICAL)

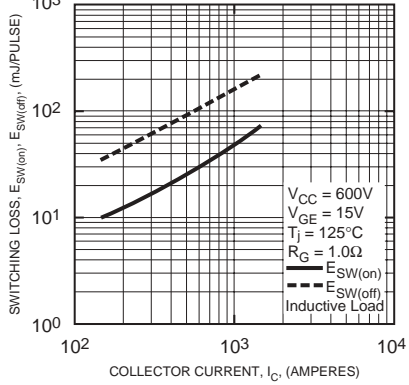

SWITCHING LOSS VS. EMITTER CURRENT (TYPICAL)

