

HIGH TEMPERATURE CERAMIC EUROBLOCKS™

Suitable for use in high temperature applications up to 600°C (1112°F).

Applications include hot melt glue guns, furnaces, heaters, process equipment and machinery. Terminal blocks are offered with mounting holes for panel mounting or free floating applications.

- Compact, space saving
- Tubular screw clamp
- Free float or panel mount
- Temperature range: 600°C (1112°F)
- Standard color: white
- Material Housing: ceramic
- Clamp: brass
- Screws: zinc plated steel



	CB4		CB6		CB16	
Insulation Material	Ceramic		Ceramic		Ceramic	
Approvals	C		C		C	
Wire Range	24-12 AWG	24-12 AWG	22-10 AWG	20-10 AWG	20-6 AWG	18-6 AWG
Voltage Rating	300V	300V	300V	300V	300V	300V
Current Rating	30 A	20 A	40 A	30 A	76 A	65 A
No. of Poles	Cat. No.	Std. Pk.	Cat. No.	Std. Pk.	Cat. No.	Std. Pk.
1 (free floating)	CB4/1	50	CB6/1	50		
2 (free floating)	CB4/2	50				
2 (with mounting holes)	CB4/2H	50	CB6/2H	50	CB16/2H	50
3 (free floating)	CB4/3	50				
3 (with mounting holes)	CB4/3H	50	CB6/3H	50	CB16/3H	50

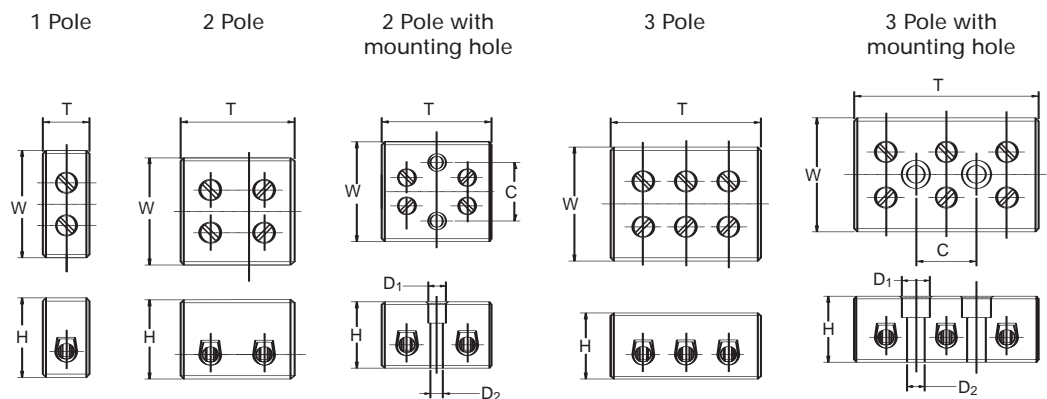

Dimensions mm

		W	T	H	C	D1	D2	Fixing Screw	Stripping Length
CB4/1	1 POLE	23	11	18.5	*				6
CB4/2	2 POLE	23	18	18.5	*				6
CB4/2H	2 POLE	23	24	18.5	14.6	6	3.5	M3X16	6
CB4/3	3 POLE	25	25	18.5	*				6
CB4/3H	3 POLE	25.4	36	18.5	13	6	3.5	M3X16	6
CB6/1	1 POLE	25	12	19.5	*				6
CB6/2H	2 POLE	25.5	26	19.5	12.6	6		M3X16	6
CB6/3H	3 POLE	25.5	41	19.5	15	6		M3X16	6
CB16/2H	2 POLE	28	31	23.2	16.5	6	3.5	M3X20	8.5
CB16/3H	3 POLE	27.5	48	23.2	17	6	3.5	M3X20	8.5

Note: All dimensions are shown in mm, to convert to inches please divide by 25.4.

MINI FEED-THROUGH

15mm DIN Rail

For wire-to-wire connecting in control, automation, instrumentation and power distribution applications.

Altech "miniature" terminal blocks offer tremendous space advantage as demanded by certain wiring configurations.

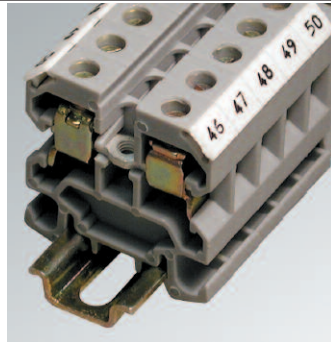

FUSE BLOCKS

Certain electrical and control systems require protection by fuses. The terminal has a hinged carrier that has a specially designed space for a cartridge type glass fuse of size Ø5 x 20 or Ø5 x 25 mm. The fuse can be engaged or disengaged by the movement of the carrier.







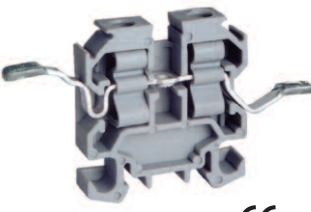
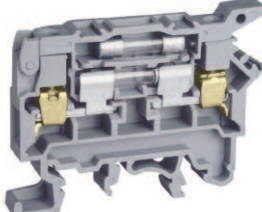
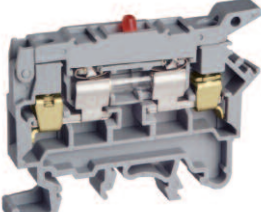

Altech fuse terminals are also available with light indication - CSFL 4U (L). A specially designed built-in circuit gives light indication in the event of fuse blow out.

Fuses are sold separately by Altech, see page 34 for details.

	CMT4			CMT4S		
Terminal Width	6 mm			6 mm		
Height x Length	29 x 27 mm			29 x 46 mm		
Stripping Length	9 mm			9 mm		
Insulation Material	Polyamide 6.6			Polyamide 6.6		
Type of Connection	2 screw clamps & 1 tapped hole for cross connection			2 screw clamps, 2 solder points and 1 tapped hole for cross connection		
Type of Fuse Used	—			—		
Approvals						
Wire Range	22-10 AWG	0.5-4 sq.mm	22-10 AWG	22-12 AWG	Upto 1.5 sq.mm	22-10 AWG
Voltage Rating	300 V	400 V	300 V	300 V	160 V	300 V
Current Rating	35 A	32 A	35 A	25 A	15 A	35 A
Torque	6 lb-in	0.5 Nm	7 lb-in	7 lb-in	0.5 Nm	7 lb-in

		Cat. No.	Std. Pk.	Cat. No.	Std. Pk.
Terminal Block		CMT4	100	CMT4S	50
End Plate		EPCMT4	50	EPCMT4	50
Isolation Partition		PPCMT4	50	PPCMT4	50
DIN Rail					
<i>for ordering information refer to page 62</i>					
End Stop		CA602	100	CA602	50
<i>for ordering information refer to page 63</i>					
Internal Jumper	 2 pole 3 pole 4 pole 10 pole	CA727/2 CA727/3 CA727/4 CA727/10	100 50 50 10	CA727/2 CA727/3 CA727/4 CA727/10	100 50 50 10
Insulated Internal Jumper	 2 pole 3 pole 4 pole 10 pole	CA747/2 CA747/3 CA747/4 CA747/10	100 50 50 10	CA747/2 CA747/3 CA747/4 CA747/10	100 50 50 10
Current Bars	 2 pole 3 pole 4 pole 10 pole 10 pole (breakable) 100 pole	CA703/1 CA704/1 CA705/1 CA732/10 CA732/10-A CA732/100	100 100 100 100 100 10	CA703/1 CA704/1 CA705/1 CA732/10 CA732/10-A CA732/100	100 100 100 100 100 10
Shorting Sleeve & Screw		CA607/S/Q	100	CA607/S/Q	100
External Jumper	 2 pole 3 pole 4 pole 10 pole	CA714/2 CA714/3 CA714/4 CA714/10	100 100 50 25	CA714/2 CA714/3 CA714/4 CA714/10	100 100 50 25
Marking Tags (MT Type)	 (MT Type on Lever)	MT2	100	MT2	100

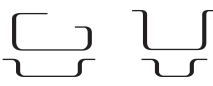
* Add required voltage to part number as a suffix, i.e. CSFL4U(L)/24 fo 24V DC

CMT4SU			CSFL4U			CSFL4U(L)*			CGMT4		
											
CE									CE		
6 mm			8 mm			8 mm			6 mm		
29 x 35.5 mm			43 x 58 mm			43 x 58 mm			28.5 x 27 mm		
9 mm			9.5 mm			9.5 mm			9 mm		
Polyamide 6.6			Polyamide 6.6			Polyamide 6.6			Polyamide 6.6		
2 uneven level solder points & 1 tapped hole for cross connection			2 screw clamps			2 screw clamps			2 screw clamps		
—			Ø5x20, Ø5x25mm			Ø5x20, Ø5x25mm			—		
											
22-14 AWG Upto 1.5 sq.mm 22-14 AWG			22-10 AWG 0.5-4 sq.mm 22-10 AWG			22-10 AWG 0.5-4 sq.mm 22-10 AWG			22-10 AWG 0.5-4 sq.mm 22-10 AWG		
300 V 160 V 300 V			600 V 600 V 600 V			600 V 600 V 600 V					
15 A 15 A 20 A			6.3 A 6.3 A 8 A			6.3 A 6.3 A 8 A					
— — —			7 lb-in 0.5 Nm 7 lb-in			7 lb-in 0.5 Nm 7 lb-in			7 lb-in 0.5 Nm 7 lb-in		
Cat. No.	Std. Pk.		Cat. No.	Std. Pk.		Cat. No.	Std. Pk.		Cat. No.	Std. Pk.	
CMT4SU	100		CSFL4U	100		CSFL4U(L)*	100		CGMT4	50	
EPCMT4	50		EPCSFL4U	50		EPCSFL4U	50				
PPCMT4	50		PPCSFL4U	50		PPCSFL4U	50				
											
CA602	50		CA602	100		CA602	100				
CA727/2	100										
CA727/3	50										
CA727/4	50										
CA727/10	10										
CA747/2	100										
CA747/3	50										
CA747/4	50										
CA747/10	10										
CA703/1	10										
CA704/1	10										
CA705/1	10										
CA732/10	10										
CA732/10-A	100										
CA732/100	10										
CA607/S/Q	10										
			CA711/2	100		CA711/2	100				
			CA711/3	100		CA711/3	100				
			CA711/4	50		CA711/4	50				
			CA711/10	25		CA711/10	25				
MT2	100		MT8	100		MT8	100		MT2	100	
			MT2	100		MT2	100				

MINI FEED-THROUGH

Panel Mount

For use when space constraints require extremely compact solutions and internal jumping is required.

Individual components can be used to build your own assemblies. Just snap the required number of terminal block components together and place a Mounting Section on each end.

The CMB 4 accepts internal jumpers and standard marking tags.

- Extremely compact and cost effective
- High density
- Screw-cage clamp
- Internal jumping provision
- Polyamide 6.6
- Standard color: gray

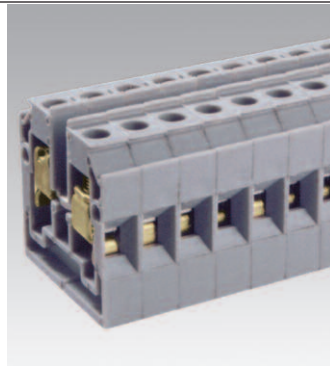

CMB4

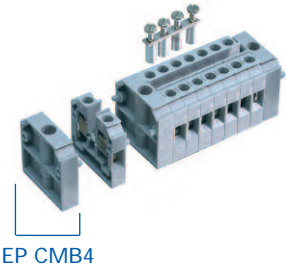

EP CMB4



Terminal Width	6 mm		
Height x Length	28 x 27 mm		
Stripping Length	9 mm		
Insulation Material	Polyamide 6.6		
Type of Connection	2 screw clamps & 1 lapped hole for cross connection		
Approvals			
Wire Range	22-10 AWG	0.5-4 sq.mm	22-10 AWG
Voltage Rating	300 V	400 V	300 V
Current Rating	35 A	32 A	35 A
Torque	7 lb-in	0.5 Nm	7 lb-in

Preassembled blocks are also available for quick and easy installations.
See Dimensions below.

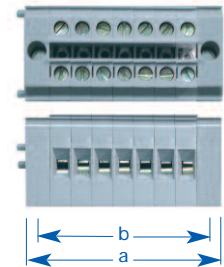

Dimensions mm (in.)
CMB4

Terminal Block	Cat. No.	Std. Pk.	
CMB4	CMB4	100	
Mounting Section	EPCMB4	50	
Separator Plate	SPCMB4	100	
Mounting Screw*			
Internal Jumper	2 pole	CA727/2	100
	3 pole	CA727/3	50
	4 pole	CA727/4	50
	10 pole	CA727/10	10
	Insulated Internal Jumper	2 pole	CA747/2
3 pole		CA747/3	50
4 pole		CA747/4	50
10 pole		CA747/10	10
Current Bars		2 pole	CA703/1
	3 pole	CA704/1	100
	4 pole	CA705/1	100
	10 pole	CA732/10	100
	10 pole (breakable)	CA732/10-A	100
	100 pole	CA732/100	10
Shorting Sleeve & Screw	CA607/S/Q	100	
External Jumper	2 pole	CA714/2	100
	3 pole	CA714/3	100
	4 pole	CA714/4	50
	10 pole	CA714/10	25
	Marking Tags (MT Type)	MT2	100

Cat No.	No. of Poles	Width (a)	Hole Spacing (b)
CMB4/2	2	26 (1.02)	19 (0.75)
CMB4/3	3	32 (1.26)	25 (0.98)
CMB4/4	4	38 (1.50)	31 (1.22)
CMB4/5	5	44 (1.73)	37 (1.46)
CMB4/6	6	50 (1.97)	43 (1.69)
CMB4/7	7	56 (2.20)	49 (1.93)
CMB4/8	8	62 (2.44)	55 (2.17)
CMB4/9	9	68 (2.68)	61 (2.40)
CMB4/10	10	74 (2.91)	67 (2.64)
CMB4/11	11	80 (3.15)	73 (2.87)
CMB4/12	12	86 (3.39)	79 (3.11)
CMB4/13	13	92 (3.62)	85 (3.35)
CMB4/14	14	98 (3.86)	91 (3.58)
CMB4/15	15	104 (4.09)	97 (3.82)
CMB4/16	16	110 (4.33)	103 (4.06)
CMB4/17	17	116 (4.57)	109 (4.29)
CMB4/18	18	122 (4.80)	115 (4.53)
CMB4/19	19	128 (5.04)	121 (4.76)
CMB4/20	20	134 (5.28)	127 (5.00)
CMB4/21	21	140 (5.51)	133 (5.24)
CMB4/22	22	146 (5.75)	139 (5.47)
CMB4/23	23	152 (5.98)	145 (5.71)
CMB4/24	24	158 (6.22)	151 (5.94)

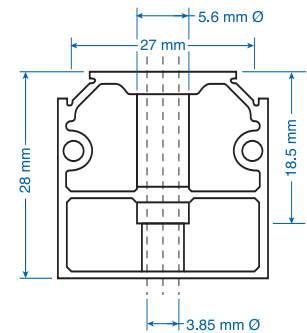

Mounting Section
EPCMB4

* Any length M3 screw may be used.

BUSBAR SYSTEM

Panel Mount

A quick reliable solution for ground, neutral or low voltage distribution applications. The Busbar System consists of a busbar, busbar supports, and screw clamp terminals for terminating wires

NEB 10 (10 x 3 mm) and NEB 6 (6 x 6 mm), tin plated copper busbars are available in one meter lengths. Both have a 140A current carrying capacity.

NES plastic support with fixing screws for holding 10 x 3 & 6 x 6 busbar makes placing of busbar an easy task. Busbars up to 200 mm length should be supported at ends by two busbar supports. For busbars exceeding 200 mm length, it is recommended to provide intermediate busbar support. Easy to operate CENC clamp secures wire to the busbar.



	CENC4	CENC16	CENC35
Terminal Width	7.5 mm	9.8 mm	14.5 mm
Height x Length	30 x 23.3 mm	36 x 23.3 mm	45 x 27.3 mm
Stripping Length	12 mm	16 mm	16 mm
Insulation Material	Polyamide 6.6	Polyamide 6.6	Polyamide 6.6
Type of Connection	1 screw clamp connection	1 screw clamp connection	1 screw clamp connection
Approvals			
Wire Range	22-12 AWG 0.5-6 sq.mm 22-12 AWG	9-6 AWG 6-16 sq.mm 10-6 AWG	7-2 AWG 10-35 sq.mm 8-2 AWG
Current Rating*	25 A 41 A	76 A 76 A	125 A 125 A
Torque	14 lb-in 0.8 Nm 14 lb-in	14 lb-in 2.0 Nm 17.5 lb-in	25 lb-in 2.5 Nm 25 lb-in

	Cat. No.	Std. Pk.	Cat. No.	Std. Pk.	Cat. No.	Std. Pk.
Terminal Block Green Cap **	CENC4	50	CENC16	50	CENC35	50
Busbar (10 x 3 mm)	NEB10	1 m	NEB10	1 m	NEB10	1 m
Busbar (6 x 6 mm)	NEB6	1 m	NEB6	1 m	NEB6	1 m
Plastic Support with Fixing Screw	NES	50	NES	50	NES	50
End Clamp/Bus bar support for rail mounting	CA202	50	CA202	50	CA202	50
Marking Tags (MT Type)	MT5	100	MT6	100	MT6	100

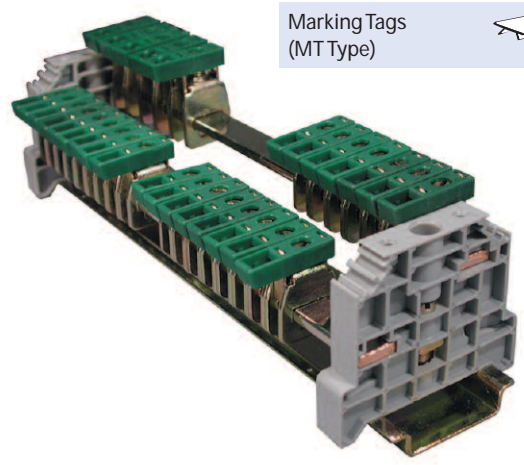

* 140A current carrying capacity of busbar should be taken into account while connecting loads.
 ** Consult for other available colors.