

FAST RECOVERY RECTIFIER DIODES

- SOFT RECOVERY
- VERY HIGH VOLTAGE
- SMALL RECOVERY CHARGE

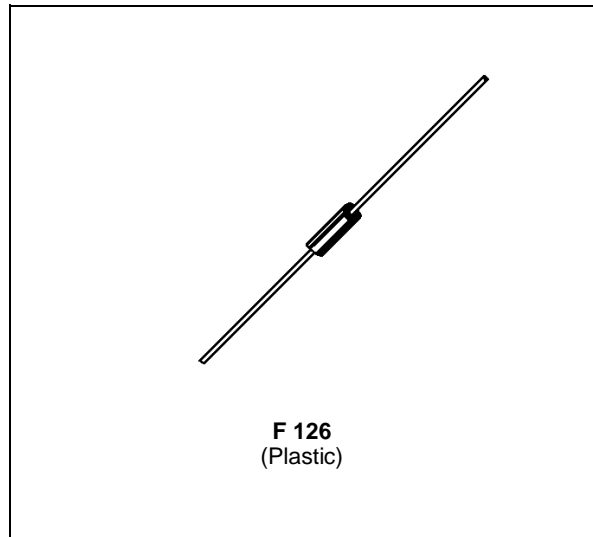

APPLICATIONS

- ANTISATURATION DIODES FOR TRANSISTOR BASE DRIVE
- SNUBBER DIODES

ABSOLUTE RATINGS (limiting values)

Symbol	Parameter		Value	Unit
I_{FRM}	Repetitive Peak Forward Current	$t_p \leq 20\mu s$	20	A
$I_{F(AV)}$	Average Forward Current *	$T_a = 75^\circ C$ $\delta = 0.5$	1	A
I_{FSM}	Surge non Repetitive Forward Current	$t_p = 10ms$ Sinusoidal	35	A
P_{tot}	Power Dissipation *	$T_a = 55^\circ C$	1.25	W
T_{stg} T_j	Storage and Junction Temperature Range		- 55 to + 150 - 55 to + 150	$^\circ C$
T_L	Maximum Lead Temperature for Soldering during 10s at 4mm from Case		230	$^\circ C$

Symbol	Parameter	BYT 11-			Unit
		600	800	1000	
V_{RRM}	Repetitive Peak Reverse Voltage	600	800	1000	V

THERMAL RESISTANCE

Symbol	Parameter	Value	Unit
$R_{th(j-a)}$	Junction-ambient*	60	$^\circ C/W$

* On infinite heatsink with 10mm lead length.

ELECTRICAL CHARACTERISTICS

STATIC CHARACTERISTICS

Symbol	Test Conditions			Min.	Typ.	Max.	Unit
I_R	$T_j = 25^\circ\text{C}$	$V_R = V_{RRM}$				20	μA
V_F	$T_j = 25^\circ\text{C}$	$I_F = 1\text{A}$				1.3	V

RECOVERY CHARACTERISTICS

Symbol	Test Conditions				Min.	Typ.	Max.	Unit
t_{rr}	$T_j = 25^\circ\text{C}$	$I_F = 0.5\text{A}$	$I_R = 1\text{A}$	$I_{rr} = 0.25\text{A}$			100	ns

To evaluate the conduction losses use the following equations:

$$V_F = 1.1 + 0.075 I_F \quad P = 1.1 \times I_{F(AV)} + 0.075 I_{F(RMS)}^2$$

Figure 1. Maximum average power dissipation versus average forward current.

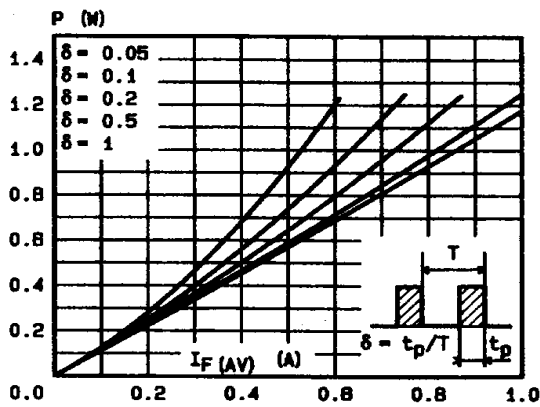

Figure 2. Average forward current versus ambient temperature.

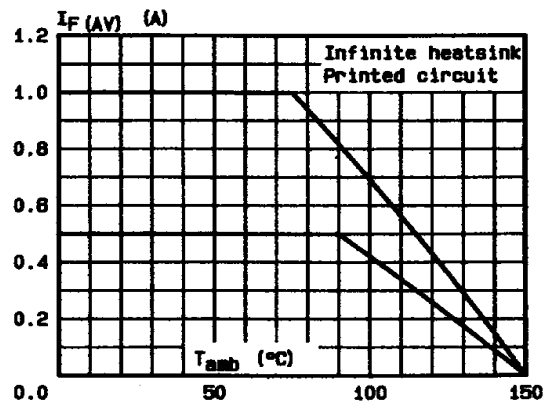
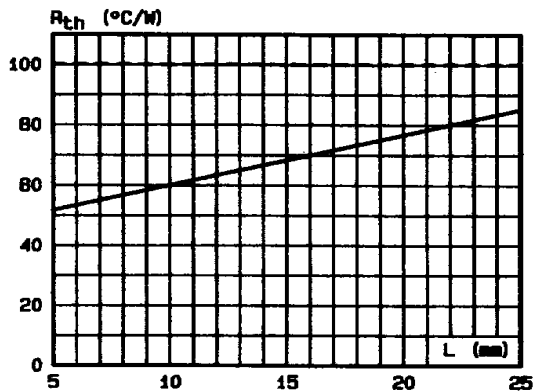
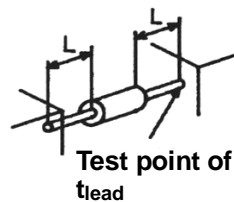

Figure 3. Thermal resistance versus lead length.



Mounting n°1
INFINITE HEATSINK



Mounting n°2
PRINTED CIRCUIT

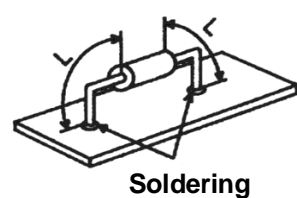

Figure 4. Transient thermal impedance junction-ambient for mounting n² versus pulse duration (L = 10 mm).

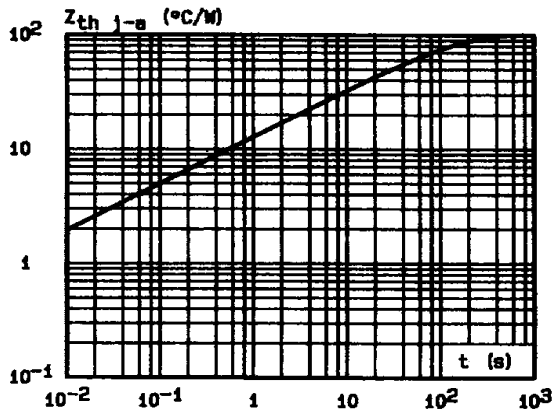

Figure 5. Peak forward current versus peak forward voltage drop (maximum values).

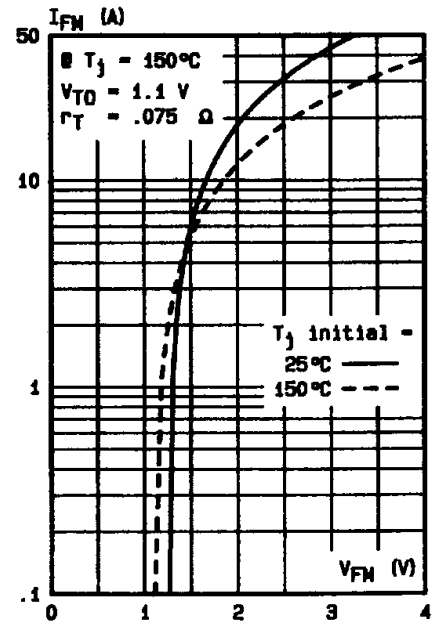

Figure 6. Capacitance versus reverse applied voltage

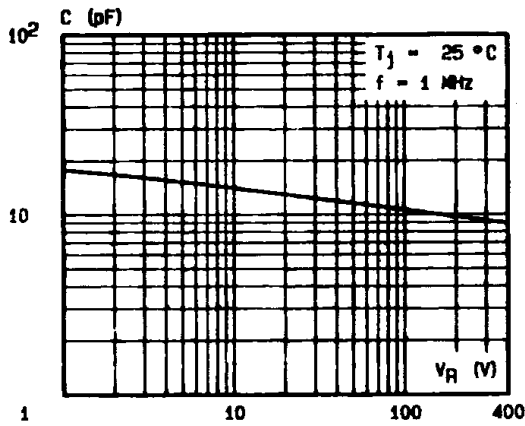
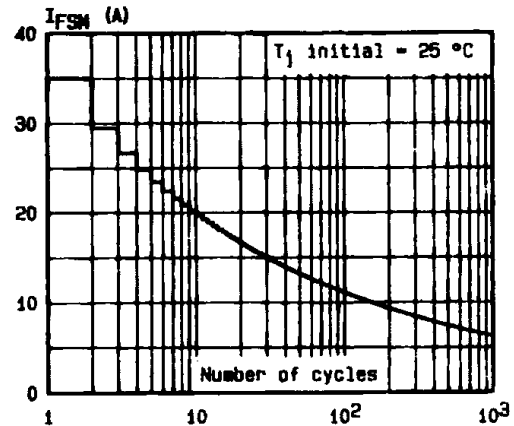
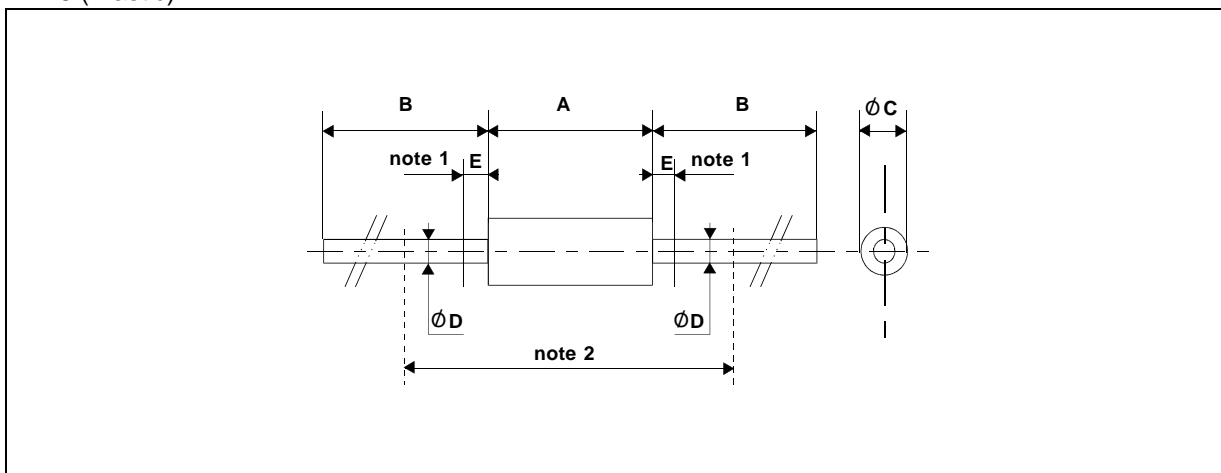

Figure 7. Non repetitive surge peak current versus number of cycles



PACKAGE MECHANICAL DATA

F 126 (Plastic)



REF.	DIMENSIONS				NOTES
	Millimeters		Inches		
	Min.	Max.	Min.	Max.	
A	6.05	6.35	0.238	0.250	1 - The lead diameter $\varnothing D$ is not controlled over zone E 2 - The minimum axial length within which the device may be placed with its leads bent at right angles is 0.59"(15 mm)
B	26		1.024		
$\varnothing C$	2.95	3.05	0.116	0.120	
$\varnothing D$	0.76	0.86	0.029	0.034	
E		1.27		0.050	

Cooling method: by convection (method A)
 Marking: type number ring at cathode end
 Weight: 0.4g

Information furnished is believed to be accurate and reliable. However, SGS-THOMSON Microelectronics assumes no responsibility for the consequences of use of such information nor for any infringement of patents or other rights of third parties which may result from its use. No license is granted by implication or otherwise under any patent or patent rights of SGS-THOMSON Microelectronics. Specifications mentioned in this publication are subject to change without notice. This publication supersedes and replaces all information previously supplied. SGS-THOMSON Microelectronics products are not authorized for use as critical components in life support devices or systems without express written approval of SGS-THOMSON Microelectronics.

© 1994 SGS-THOMSON Microelectronics - Printed in Italy - All rights reserved.

SGS-THOMSON Microelectronics GROUP OF COMPANIES

Australia - Brazil - France - Germany - Hong Kong - Italy - Japan - Korea - Malaysia - Malta - Morocco - The Netherlands - Singapore - Spain - Sweden - Switzerland - Taiwan - United Kingdom - U.S.A.