



BU406

NPN PLANAR TRANSISTOR

SILICON NPN SWITCHING TRANSISTOR

■ DESCRIPTION

The UTC **BU406** is a NPN epitaxial planar transistor. It is a fast switching device for use in horizontal deflection output stages of large screens MTV receivers with 110 CRT.

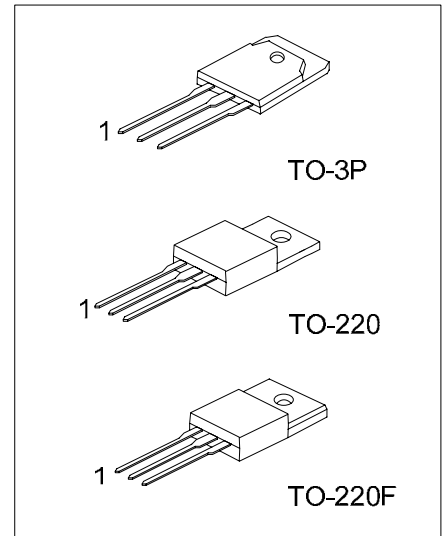

*Pb-free plating product number: BU406L

■ ORDERING INFORMATION

Order Number		Package	Pin Assignment			Packing
Normal	Lead Free Plating		1	2	3	
BU406-x-TA3-T	BU406L-x-TA3-T	TO-220	B	C	E	Tube
BU406-x-TF3-T	BU406L-x-TF3-T	TO-220F	B	C	E	Tube
BU406-x-T3P-T	BU406L-x-T3P-T	TO-3P	B	C	E	Tube

<p>BU406L-x-TA3-T</p>	<p>(1) T: Tube (2) TA3: TO:220, TF3: TO-220F, T3P: TO-3P (3) x: refer to Classification of h_{FE} (4) L: Lead Free Plating, Blank: Pb/Sn</p>
-----------------------	--

■ ABSOLUTE MAXIMUM RATING

PARAMETER	SYMBOL	RATINGS	UNIT
Collector-Base Voltage ($I_E=0$)	V_{CBO}	400	V
Collector-Emitter Voltage ($V_{BE}=-1.5V$)	V_{CEV}	400	V
Collector-Emitter Voltage ($I_B=0$)	V_{CEO}	200	V
Emitter-Base Voltage ($I_C=0$)	V_{EBO}	6	V
Collector Current	I_C	7	A
Collector Peak Current (repetitive)	I_{CM}	10	A
Collector Peak Current ($t_p=10ms$)	I_{CM}	15	A
Base Current	I_B	4	A
Collector Dissipation ($T_C \leq 25$)	P_C	60	W
Junction Temperature	T_J	150	
Storage Temperature	T_{STG}	-65 ~ +150	

Note Absolute maximum ratings are those values beyond which the device could be permanently damaged. Absolute maximum ratings are stress ratings only and functional device operation is not implied.

■ THERMAL DATA

PARAMETER	SYMBOL	RATINGS	UNIT
Thermal Resistance, Junction to Ambient	θ_{JA}	70	/W
Thermal Resistance, Junction to Case	θ_{JC}	2.08	/W

■ ELECTRICAL CHARACTERISTICS ($T_a=25$)

PARAMETER	SYMBOL	TEST CONDITIONS	MIN	TYP	MAX	UNIT
Collect Cutoff Current ($V_{BE}=0$)	I_{CES}	$V_{CE}=400V$			5	mA
		$V_{CE}=250V$ $T_C=150^\circ C$			100	μA
		$V_{CE}=250V$			1	mA
Emitter Cut-off Current ($I_C=0$)	I_{EBO}	$V_{BE}=6V$			1	mA
Collector-Emitter Saturation Voltage	$V_{CE(SAT)*}$	$I_C=5A, I_B=0.5A$			1	V
Base-Emitter Saturation Voltage	$V_{BE(SAT)*}$	$I_C=5A, I_B=0.5A$			1.2	V
DC Current Gain	h_{FE}	$V_{CE}=10V, I_C=500mA$	70		240	
Transition Frequency	f_T	$I_C=500mA, V_{CE}=10V$	10			MHz
Turn-off Time	t_{OFF}	$I_C=5A, I_B=0.5A$			0.75	μs
Second Breakdown Collector Current	$I_{s/b}$	$V_{CE}=40V, t=10ms$		4		A

* Pulse duration=300 μs , duty cycle 1.5%

■ CLASSIFICATION OF h_{FE}

RANK	A	B
RANGE	70 ~ 120	110 ~ 240

TYPICAL CHARACTERISTICS

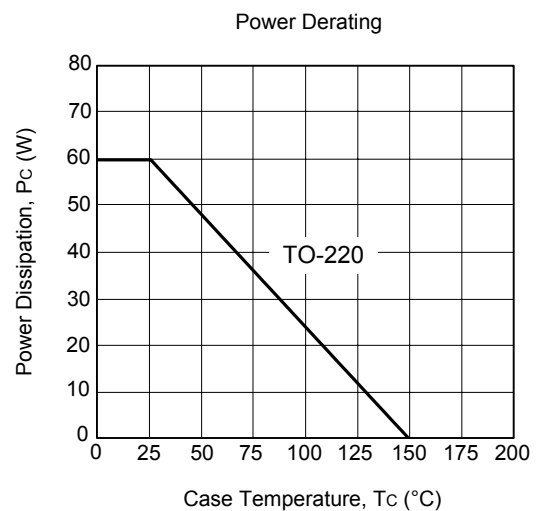
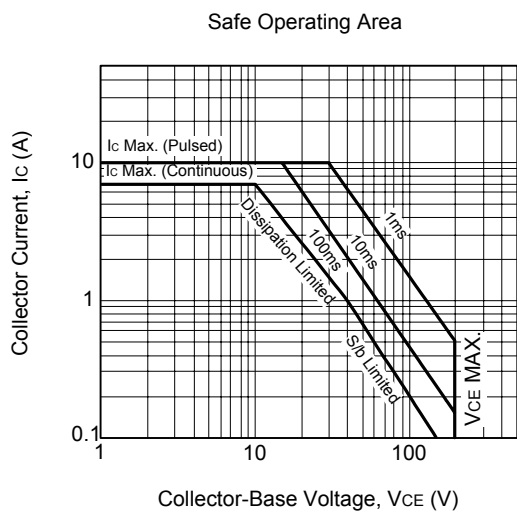
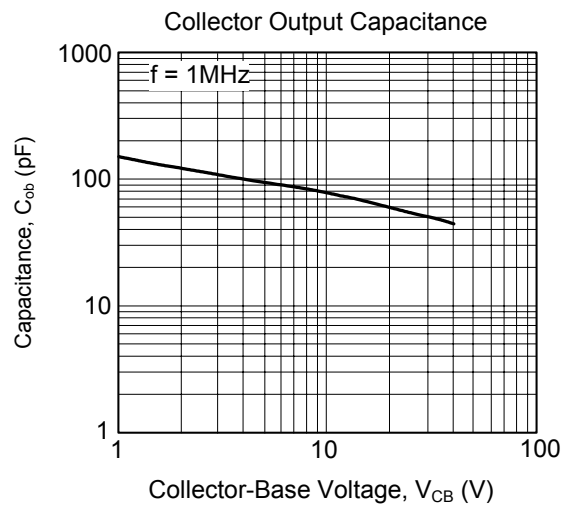
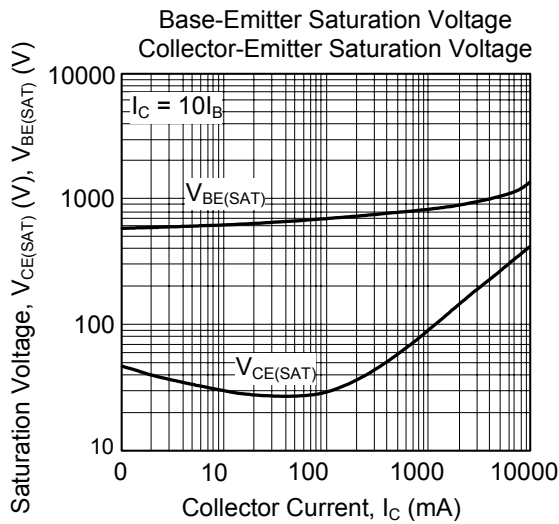
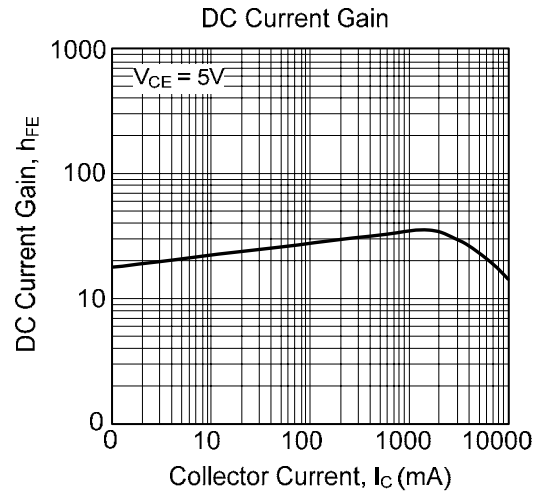
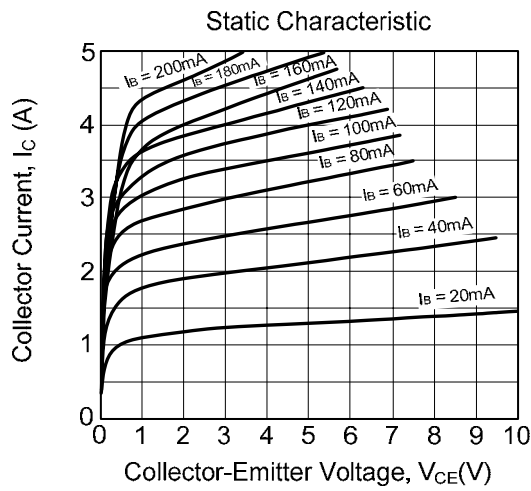

UTC assumes no responsibility for equipment failures that result from using products at values that exceed, even momentarily, rated values (such as maximum ratings, operating condition ranges, or other parameters) listed in products specifications of any and all UTC products described or contained herein. UTC products are not designed for use in life support appliances, devices or systems where malfunction of these products can be reasonably expected to result in personal injury. Reproduction in whole or in part is prohibited without the prior written consent of the copyright owner. The information presented in this document does not form part of any quotation or contract, is believed to be accurate and reliable and may be changed without notice.