

### FEATURES

- Wide  $V_{CC}$  operation voltage : 2.4V ~ 3.6V
- Very low power consumption :
  - $V_{CC} = 3.0V$     Operation current : 25mA (Max.) at 55ns  
2mA (Max.) at 1MHz  
Standby current : 3/5uA (Max.) at 70/85°C
- High speed access time :
  - 55            55ns(Max.) at  $V_{CC}=2.7\sim 3.6V$
  - 70            70ns(Max.) at  $V_{CC}=2.4\sim 3.6V$
- Automatic power down when chip is deselected
- Easy expansion with  $\overline{CE}$  and  $\overline{OE}$  options
- I/O Configuration x8/x16 selectable by  $\overline{LB}$  and  $\overline{UB}$  pin.
- Three state outputs and TTL compatible
- Fully static operation
- Data retention supply voltage as low as 1.5V

### DESCRIPTION

The BS616LV2019 is a high performance, very low power CMOS Static Random Access Memory organized as 131,072 by 16 bits and operates from a wide range of 2.4V to 3.6V supply voltage. Advanced CMOS technology and circuit techniques provide both high speed and low power features with maximum CMOS standby current of 3/5uA at 3V at 70/85°C and maximum access time of 55/70ns.

Easy memory expansion is provided by an active LOW chip enable ( $\overline{CE}$ ) and active LOW output enable ( $\overline{OE}$ ) and three-state output drivers.

The BS616LV2019 has an automatic power down feature, reducing the power consumption significantly when chip is deselected. The BS616LV2019 is available in DICE form, JEDEC standard 48-pin TSOP Type I package and 48-ball BGA package.

### POWER CONSUMPTION

PRODUCT FAMILY	OPERATING TEMPERATURE	POWER DISSIPATION				PKG TYPE
		STANDBY ( $I_{CCSB1, Max}$ )	Operating ( $I_{CC, Max}$ )			
			$V_{CC}=3.0V$			
		$V_{CC}=3.0V$	1MHz	10MHz	$f_{Max}$	
BS616LV2019DC	Commercial +0°C to +70°C	3.0uA	1.5mA	9mA	23mA	DICE
BS616LV2019AC						BGA-48-0608
BS616LV2019TC						TSOP I-48
BS616LV2019AI	Industrial -40°C to +85°C	5.0uA	2mA	10mA	25mA	BGA-48-0608
BS616LV2019TI						TSOP I-48

### PIN CONFIGURATIONS

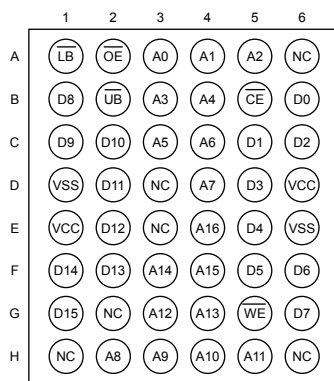

48-ball BGA top view

### BLOCK DIAGRAM

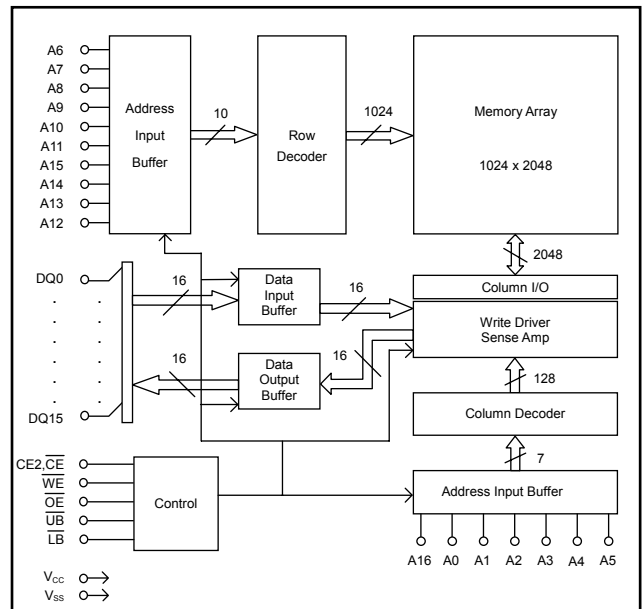

Brilliance Semiconductor, Inc. reserves the right to change products and specifications without notice.

**■ PIN DESCRIPTIONS**

Name	Function
<b>A0-A16 Address Input</b>	These 17 address inputs select one of the 262,144 x 16 bit in the RAM
<b><math>\overline{\text{CE}}</math> Chip Enable 1 Input <b>CE2 Chip Enable 2 Input</b></b>	$\overline{\text{CE}}$ is active LOW and CE2 is active HIGH. Both chip enables must be active when data read from or write to the device. If either chip enable is not active, the device is deselected and is in standby power mode. The DQ pins will be in the high impedance state when the device is deselected. (48B BGA ignore CE2 pin)
<b><math>\overline{\text{WE}}</math> Write Enable Input</b>	The write enable input is active LOW and controls read and write operations. With the chip selected, when $\overline{\text{WE}}$ is HIGH and $\overline{\text{OE}}$ is LOW, output data will be present on the DQ pins; when $\overline{\text{WE}}$ is LOW, the data present on the DQ pins will be written into the selected memory location.
<b><math>\overline{\text{OE}}</math> Output Enable Input</b>	The output enable input is active LOW. If the output enable is active while the chip is selected and the write enable is inactive, data will be present on the DQ pins and they will be enabled. The DQ pins will be in the high impedance state when $\overline{\text{OE}}$ is inactive.
<b><math>\overline{\text{LB}}</math> and <math>\overline{\text{UB}}</math> Data Byte Control Input</b>	Lower byte and upper byte data input/output control pins.
<b>DQ0-DQ15 Data Input/Output Ports</b>	16 bi-directional ports are used to read data from or write data into the RAM.
<b>V<sub>CC</sub></b>	Power Supply
<b>V<sub>SS</sub></b>	Ground

**■ TRUTH TABLE**

MODE	$\overline{\text{CE}}$	CE2 <sup>(1)</sup>	$\overline{\text{WE}}$	$\overline{\text{OE}}$	$\overline{\text{LB}}$	$\overline{\text{UB}}$	DQ0~DQ7	DQ8~DQ15	V <sub>CC</sub> CURRENT
Chip De-selected (Power Down)	H	X	X	X	X	X	High Z	High Z	I <sub>CCSB</sub> , I <sub>CCSB1</sub>
	X	L	X	X	X	X	High Z	High Z	I <sub>CCSB</sub> , I <sub>CCSB1</sub>
	X	X	X	X	H	H	High Z	High Z	I <sub>CCSB</sub> , I <sub>CCSB1</sub>
Output Disabled	L	H	H	H	L	X	High Z	High Z	I <sub>CC</sub>
	L	H	H	H	X	L	High Z	High Z	I <sub>CC</sub>
Read	L	H	H	L	L	L	D <sub>OUT</sub>	D <sub>OUT</sub>	I <sub>CC</sub>
					H	L	High Z	D <sub>OUT</sub>	I <sub>CC</sub>
					L	H	D <sub>OUT</sub>	High Z	I <sub>CC</sub>
Write	L	H	L	X	L	L	D <sub>IN</sub>	D <sub>IN</sub>	I <sub>CC</sub>
					H	L	X	D <sub>IN</sub>	I <sub>CC</sub>
					L	H	D <sub>IN</sub>	X	I <sub>CC</sub>

1. 48BGA ignore CE2 condition.

2. H means V<sub>IH</sub>; L means V<sub>IL</sub>; X means don't care (Must be V<sub>IH</sub> or V<sub>IL</sub> state)

**■ ABSOLUTE MAXIMUM RATINGS <sup>(1)</sup>**

SYMBOL	PARAMETER	RATING	UNITS
V <sub>TERM</sub>	Terminal Voltage with Respect to GND	-0.5 <sup>(2)</sup> to 5.0	V
T <sub>BIAS</sub>	Temperature Under Bias	-40 to +125	°C
T <sub>STG</sub>	Storage Temperature	-60 to +150	°C
P <sub>T</sub>	Power Dissipation	1.0	W
I <sub>OUT</sub>	DC Output Current	20	mA

1. Stresses greater than those listed under ABSOLUTE MAXIMUM RATINGS may cause permanent damage to the device. This is a stress rating only and functional operation of the device at these or any other conditions above those indicated in the operational sections of this specification is not implied. Exposure to absolute maximum rating conditions for extended periods may affect reliability.
2. -2.0V in case of AC pulse width less than 30 ns.

**■ OPERATING RANGE**

RANG	AMBIENT TEMPERATURE	V <sub>CC</sub>
Commercial	0°C to +70°C	2.4V ~ 3.6V
Industrial	-40°C to +85°C	2.4V ~ 3.6V

**■ CAPACITANCE <sup>(1)</sup> (T<sub>A</sub> = 25°C, f = 1.0MHz)**

SYMBOL	PARAMETER	CONDITIONS	MAX.	UNITS
C <sub>IN</sub>	Input Capacitance	V <sub>IN</sub> = 0V	6	pF
C <sub>IO</sub>	Input/Output Capacitance	V <sub>I/O</sub> = 0V	8	pF

1. This parameter is guaranteed and not 100% tested.

**■ DC ELECTRICAL CHARACTERISTICS (T<sub>A</sub> = -40°C to +85°C)**

PARAMETER NAME	PARAMETER	TEST CONDITIONS	MIN.	TYP. <sup>(1)</sup>	MAX.	UNITS	
V <sub>CC</sub>	Power Supply		2.4	--	3.6	V	
V <sub>IL</sub>	Input Low Voltage		-0.5 <sup>(2)</sup>	--	0.8	V	
V <sub>IH</sub>	Input High Voltage		2.2	--	V <sub>CC</sub> +0.3 <sup>(3)</sup>	V	
I <sub>IL</sub>	Input Leakage Current	V <sub>IN</sub> = 0V to V <sub>CC</sub> CE = V <sub>IH</sub> or CE2 <sup>(7)</sup> = V <sub>IL</sub>	--	--	1	uA	
I <sub>LO</sub>	Output Leakage Current	V <sub>I/O</sub> = 0V to V <sub>CC</sub> , CE = V <sub>IH</sub> or CE2 <sup>(7)</sup> = V <sub>IL</sub> or OE = V <sub>IH</sub>	--	--	1	uA	
V <sub>OL</sub>	Output Low Voltage	V <sub>CC</sub> = Max, I <sub>OL</sub> = 2.0mA	--	--	0.4	V	
V <sub>OH</sub>	Output High Voltage	V <sub>CC</sub> = Min, I <sub>OH</sub> = -1.0mA	2.4	--	--	V	
I <sub>CC</sub> <sup>(5)</sup>	Operating Power Supply Current	CE = V <sub>IL</sub> and CE2 <sup>(7)</sup> = V <sub>IH</sub> , I <sub>IO</sub> = 0mA, f = F <sub>MAX</sub> <sup>(4)</sup>	V <sub>CC</sub> =3.0V	--	--	25	mA
I <sub>CC1</sub>	Operating Power Supply Current	CE = V <sub>IL</sub> and CE2 <sup>(7)</sup> = V <sub>IH</sub> , I <sub>IO</sub> = 0mA, f = 1MHz	V <sub>CC</sub> =3.0V	--	--	2	mA
I <sub>CCSB</sub>	Standby Current – TTL	CE = V <sub>IH</sub> or CE2 <sup>(7)</sup> = V <sub>IL</sub> , I <sub>IO</sub> = 0mA	V <sub>CC</sub> =3.0V	--	--	0.5	mA
I <sub>CCSB1</sub> <sup>(6)</sup>	Standby Current – CMOS	CE ≥ V <sub>CC</sub> -0.2V or CE2 <sup>(7)</sup> ≤ 0.2V, V <sub>IN</sub> ≥ V <sub>CC</sub> -0.2V or V <sub>IN</sub> ≤ 0.2V	V <sub>CC</sub> =3.0V	--	0.3	5	uA

1. Typical characteristics are at T<sub>A</sub>=25°C and not 100% tested.
2. Undershoot: -1.0V in case of pulse width less than 20 ns.
3. Overshoot: V<sub>CC</sub>+1.0V in case of pulse width less than 20 ns.
4. F<sub>MAX</sub>=1/t<sub>RC</sub>.

5. I<sub>CC</sub> (MAX.) is 23mA at V<sub>CC</sub>=3.0V and T<sub>A</sub>=70°C.
6. I<sub>CCSB1</sub>(MAX.) is 3uA at V<sub>CC</sub>=3.0V and T<sub>A</sub>=70°C.
7. 48B BGA ignore CE2 condition.

**■ DATA RETENTION CHARACTERISTICS ( $T_A = -40^{\circ}\text{C}$  to  $+85^{\circ}\text{C}$ )**

SYMBOL	PARAMETER	TEST CONDITIONS	MIN.	TYP. <sup>(1)</sup>	MAX.	UNITS
$V_{DR}$	$V_{CC}$ for Data Retention	$\overline{CE} \geq V_{CC}-0.2\text{V}$ or $CE2^{(4)} \leq 0.2\text{V}$ , $V_{IN} \geq V_{CC}-0.2\text{V}$ or $V_{IN} \leq 0.2\text{V}$	1.5	--	--	V
$I_{CCDR}^{(3)}$	Data Retention Current	$\overline{CE} \geq V_{CC}-0.2\text{V}$ or $CE2^{(4)} \leq 0.2\text{V}$ , $V_{IN} \geq V_{CC}-0.2\text{V}$ or $V_{IN} \leq 0.2\text{V}$	--	0.1	1.0	$\mu\text{A}$
$t_{CDR}$	Chip Deselect to Data Retention Time	See Retention Waveform	0	--	--	ns
$t_R$	Operation Recovery Time		$t_{RC}^{(2)}$	--	--	ns

1.  $V_{CC}=1.5\text{V}$ ,  $T_A=25^{\circ}\text{C}$  and not 100% tested.
2.  $t_{RC}$  = Read Cycle Time.
3.  $I_{CCDR(\text{Max.})}$  is  $0.7\mu\text{A}$  at  $T_A=70^{\circ}\text{C}$ .
4. 48B BGA ignore CE2 condition

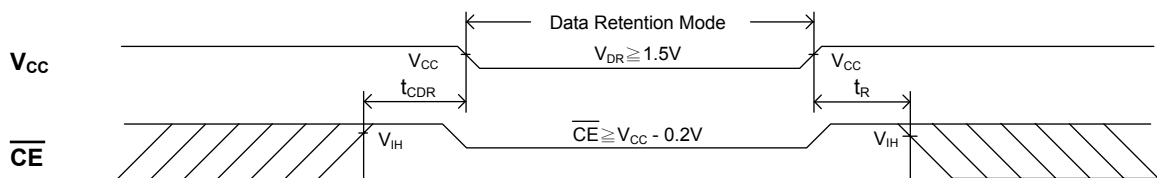
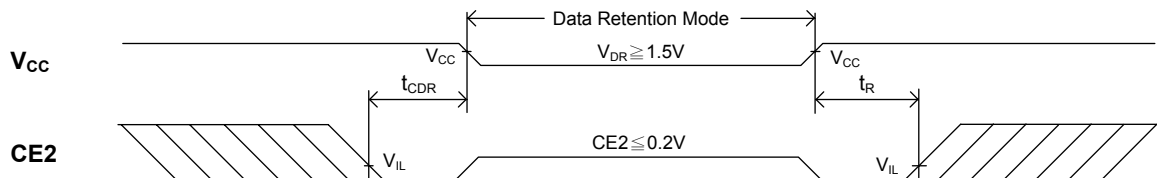

**■ LOW  $V_{CC}$  DATA RETENTION WAVEFORM (1) ( $\overline{CE}$  Controlled)**

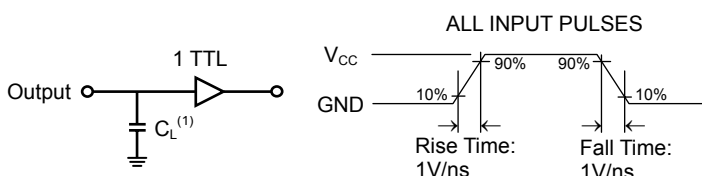
**■ LOW  $V_{CC}$  DATA RETENTION WAVEFORM (2) (CE2 Controlled)**

**■ AC TEST CONDITIONS**  
(Test Load and Input/Output Reference)

Input Pulse Levels	$V_{CC} / 0\text{V}$
Input Rise and Fall Times	1V/ns
Input and Output Timing Reference Level	0.5 $V_{CC}$
Output Load	$t_{CLZ}$ , $t_{OLZ}$ , $t_{CHZ}$ , $t_{OHZ}$ , $t_{WHZ}$
	Others

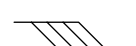

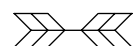
1. Including jig and scope capacitance.

**■ KEY TO SWITCHING WAVEFORMS**

WAVEFORM	INPUTS	OUTPUTS
	MUST BE STEADY	MUST BE STEADY
	MAY CHANGE FROM "H" TO "L"	WILL BE CHANGE FROM "H" TO "L"
	MAY CHANGE FROM "L" TO "H"	WILL BE CHANGE FROM "L" TO "H"
	DON'T CARE ANY CHANGE PERMITTED	CHANGE : STATE UNKNOWN
	DOES NOT APPLY	CENTER LINE IS HIGH INPEDANCE "OFF" STATE

**■ AC ELECTRICAL CHARACTERISTICS ( $T_A = -40^{\circ}\text{C}$  to  $+85^{\circ}\text{C}$ )**
**READ CYCLE**

JEDEC PARAMETER NAME	PARAMETER NAME	DESCRIPTION	CYCLE TIME : 55ns ( $V_{CC}=2.7\sim 3.6\text{V}$ )			CYCLE TIME : 70ns ( $V_{CC}=2.4\sim 3.6\text{V}$ )			UNITS
			MIN.	TYP.	MAX.	MIN.	TYP.	MAX.	
$t_{AVAX}$	$t_{RC}$	Read Cycle Time	55	--	--	70	--	--	ns
$t_{AVQX}$	$t_{AA}$	Address Access Time	--	--	55	--	--	70	ns
$t_{ELQV1}$	$t_{ACS1}$	Chip Select Access Time ( $\overline{\text{CE}}$ )	--	--	55	--	--	70	ns
$t_{ELQV2}$	$t_{ACS2}$	Chip Select Access Time (CE2)	--	--	55	--	--	70	ns
$t_{BLQV}$	$t_{BA}$	Data Byte Control Access Time ( $\overline{\text{LB}}, \overline{\text{UB}}$ )	--	--	55	--	--	70	ns
$t_{GLQV}$	$t_{OE}$	Output Enable to Output Valid	--	--	30	--	--	35	ns
$t_{ELQX1}$	$t_{CLZ1}$	Chip Select to Output Low Z ( $\overline{\text{CE}}$ )	10	--	--	10	--	--	ns
$t_{ELQX2}$	$t_{CLZ2}$	Chip Select to Output Low Z (CE2)	10	--	--	10	--	--	ns
$t_{BLQX}$	$t_{BE}$	Data Byte Control to Output Low Z ( $\overline{\text{LB}}, \overline{\text{UB}}$ )	10	--	--	10	--	--	ns
$t_{GLQX}$	$t_{OLZ}$	Output Enable to Output Low Z	5	--	--	5	--	--	ns
$t_{EHQZ1}$	$t_{CHZ1}$	Chip Select to Output High Z ( $\overline{\text{CE}}$ )	--	--	30	--	--	35	ns
$t_{EHQZ2}$	$t_{CHZ2}$	Chip Select to Output High Z (CE2)	--	--	30	--	--	35	ns
$t_{BHQZ}$	$t_{BDO}$	Data Byte Control to Output High Z ( $\overline{\text{LB}}, \overline{\text{UB}}$ )	--	--	30	--	--	35	ns
$t_{GHQZ}$	$t_{OHZ}$	Output Enable to Output High Z	--	--	25	--	--	30	ns
$t_{AVQX}$	$t_{OH}$	Data Hold from Address Change	10	--	--	10	--	--	ns

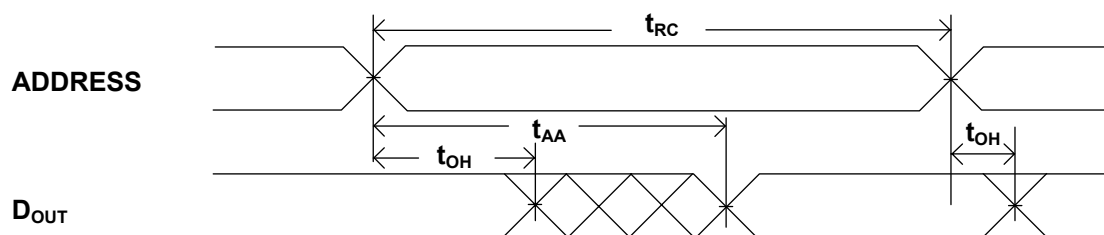
**■ SWITCHING WAVEFORMS (READ CYCLE)**
**READ CYCLE 1 <sup>(1,2,4)</sup>**

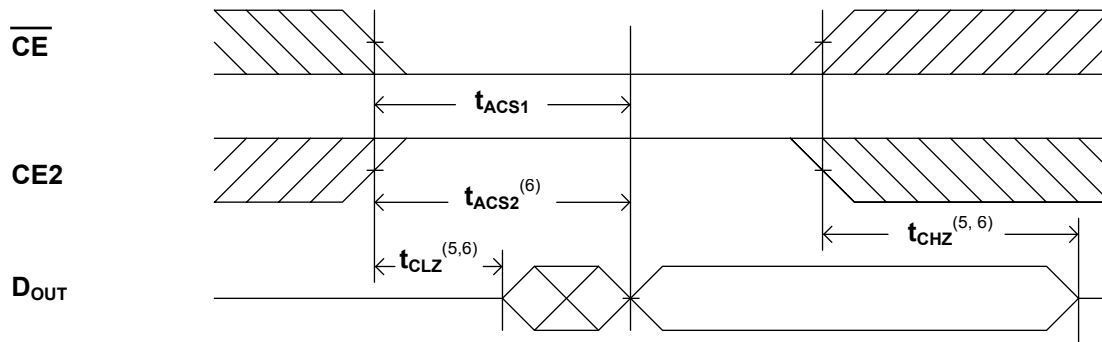
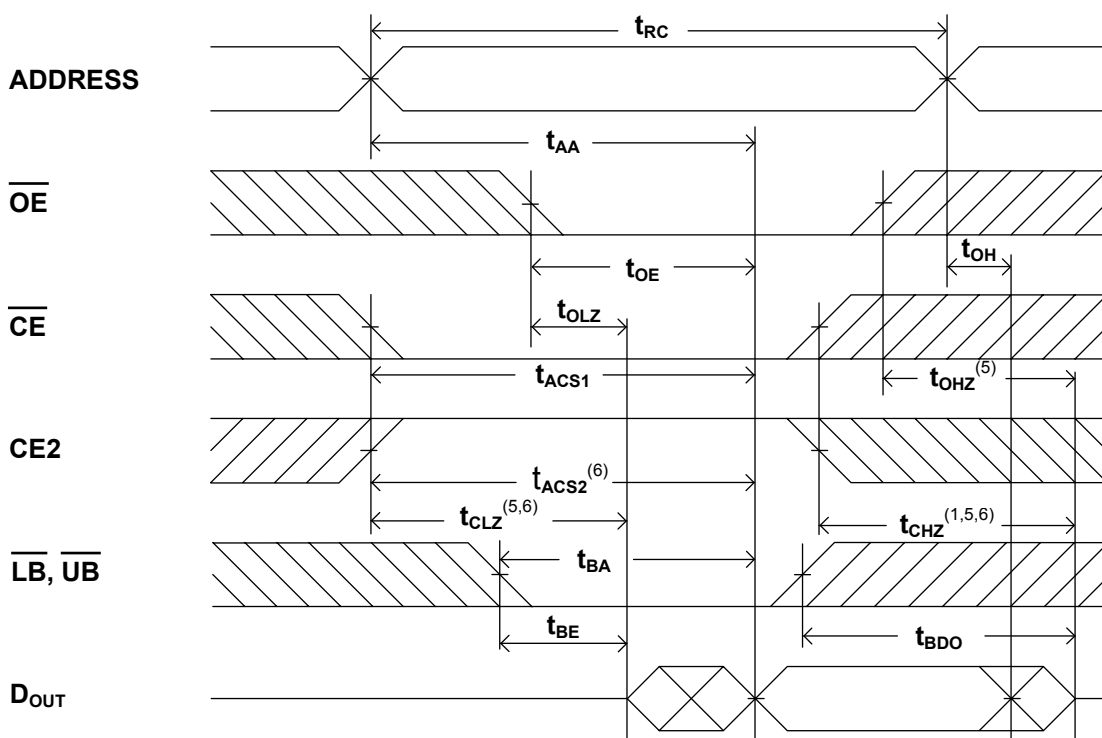
**READ CYCLE 2** <sup>(1,3,4)</sup>

**READ CYCLE 3** <sup>(1, 4)</sup>

**NOTES:**

1.  $\overline{WE}$  is high in read Cycle.
2. Device is continuously selected when  $\overline{CE} = V_{IL}$  and  $CE2 = V_{IH}$ .
3. Address valid prior to or coincident with  $\overline{CE}$  transition low and/or CE2 transition high.
4.  $\overline{OE} = V_{IL}$ .
5. Transition is measured  $\pm 500\text{mV}$  from steady state with  $C_L = 5\text{pF}$ .  
The parameter is guaranteed but not 100% tested.
6. 48B BGA ignore this parameters related to CE2.

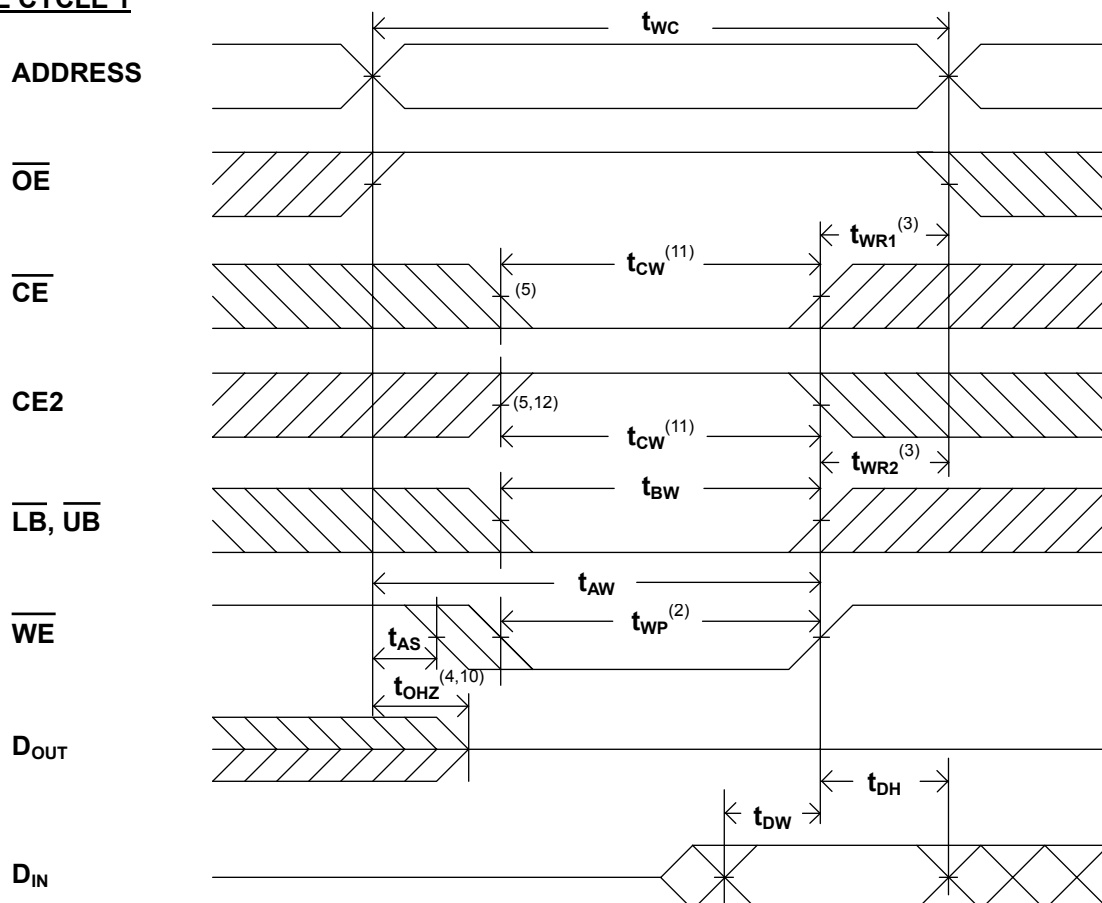
**■ AC ELECTRICAL CHARACTERISTICS ( $T_A = -40^{\circ}\text{C}$  to  $+85^{\circ}\text{C}$ )**
**WRITE CYCLE**

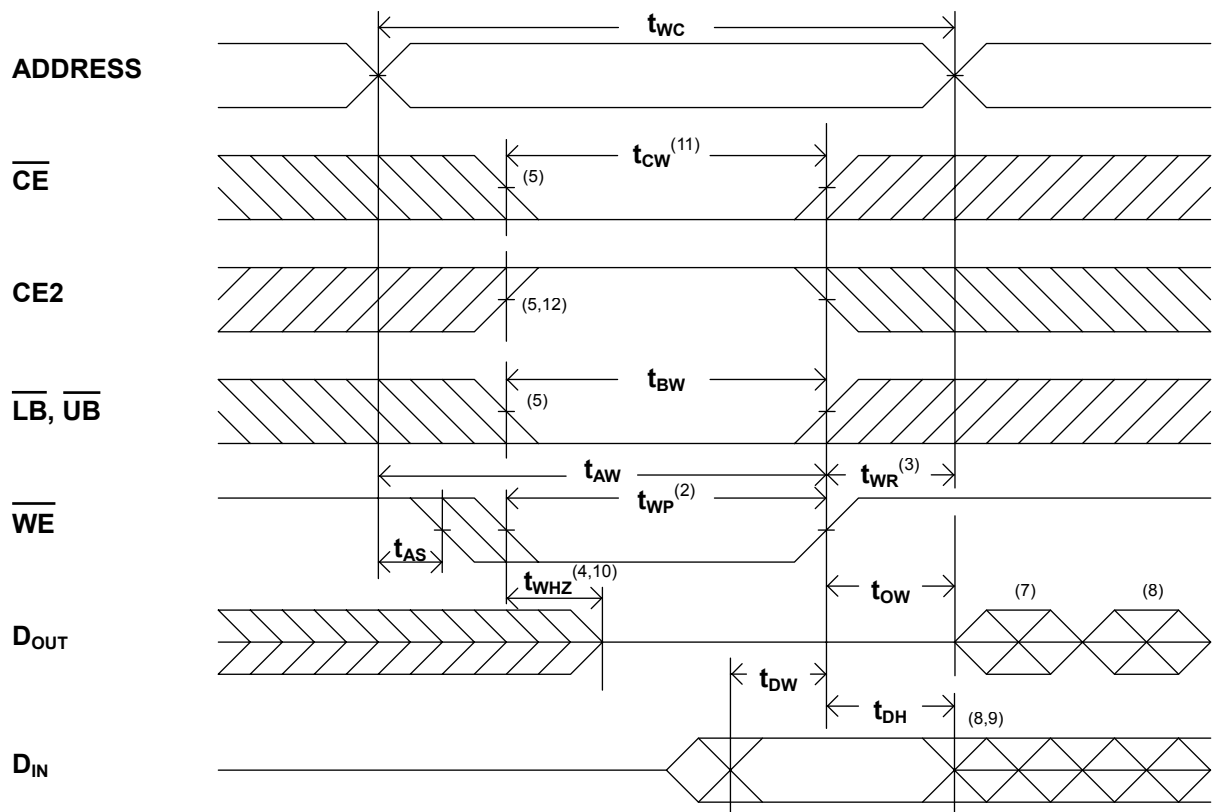
JEDEC PARAMETER NAME	PARAMETER NAME	DESCRIPTION	CYCLE TIME : 55ns ( $V_{CC}=2.7\sim 3.6\text{V}$ )			CYCLE TIME : 70ns ( $V_{CC}=2.4\sim 3.6\text{V}$ )			UNITS
			MIN.	TYP.	MAX.	MIN.	TYP.	MAX.	
$t_{AVAX}$	$t_{WC}$	Write Cycle Time	55	--	--	70	--	--	ns
$t_{AVWL}$	$t_{AS}$	Address Set up Time	0	--	--	0	--	--	ns
$t_{AVWH}$	$t_{AW}$	Address Valid to End of Write	55	--	--	70	--	--	ns
$t_{ELWH}$	$t_{CW}$	Chip Select to End of Write	55	--	--	70	--	--	ns
$t_{BLWH}$	$t_{BW}$	Data Byte Control to End of Write ( $\overline{\text{LB}}, \overline{\text{UB}}$ )	25	--	--	30	--	--	ns
$t_{WLWH}$	$t_{WP}$	Write Pulse Width	30	--	--	35	--	--	ns
$t_{WHAX1}$	$t_{WR1}$	Write Recovery Time ( $\overline{\text{CE}}, \overline{\text{WE}}$ )	0	--	--	0	--	--	ns
$t_{WHAX2}$	$t_{WR2}$	Write Recovery Time ( $\text{CE2}$ )	0	--	--	0	--	--	ns
$t_{WLQZ}$	$t_{WHZ}$	Write to Output High Z	--	--	25	--	--	30	ns
$t_{DVWH}$	$t_{DW}$	Data to Write Time Overlap	25	--	--	30	--	--	ns
$t_{WHDX}$	$t_{DH}$	Data Hold from Write Time	0	--	--	0	--	--	ns
$t_{GHQZ}$	$t_{OHZ}$	Output Disable to Output in High Z	--	--	25	--	--	30	ns
$t_{WHQX}$	$t_{OW}$	End of Write to Output Active	5	--	--	5	--	--	ns

**■ SWITCHING WAVEFORMS (WRITE CYCLE)**
**WRITE CYCLE 1 <sup>(1)</sup>**

**WRITE CYCLE 2** <sup>(1,6)</sup>

**NOTES:**

1.  $\overline{WE}$  must be high during address transitions.
2. The internal write time of the memory is defined by the overlap of  $\overline{CE}$  and CE2 active and  $\overline{WE}$  low. All signals must be active to initiate a write and any one signal can terminate a write by going inactive. The data input setup and hold timing should be referenced to the second transition edge of the signal that terminates the write.
3.  $t_{WR}^{(3)}$  is measured from the earlier of  $\overline{CE}$  or  $\overline{WE}$  going high or CE2 going low at the end of write cycle.
4. During this period, DQ pins are in the output state so that the input signals of opposite phase to the outputs must not be applied.
5. If the  $\overline{CE}$  low transition or the CE2 high transition occurs simultaneously with the  $\overline{WE}$  low transitions or after the  $\overline{WE}$  transition, output remain in a high impedance state.
6.  $\overline{OE}$  is continuously low ( $\overline{OE} = V_{IL}$ ).
7.  $D_{OUT}$  is the same phase of write data of this write cycle.
8.  $D_{OUT}$  is the read data of next address.
9. If  $\overline{CE}$  is low and CE2 is high during this period, DQ pins are in the output state. Then the data input signals of opposite phase to the outputs must not be applied to them.
10. Transition is measured  $\pm 500\text{mV}$  from steady state with  $C_L = 5\text{pF}$ .  
The parameter is guaranteed but not 100% tested.
11.  $t_{CW}^{(11)}$  is measured from the later of  $\overline{CE}$  going low or CE2 going high to the end of write.
12. 48B BGA ignore this parameters related to CE2.

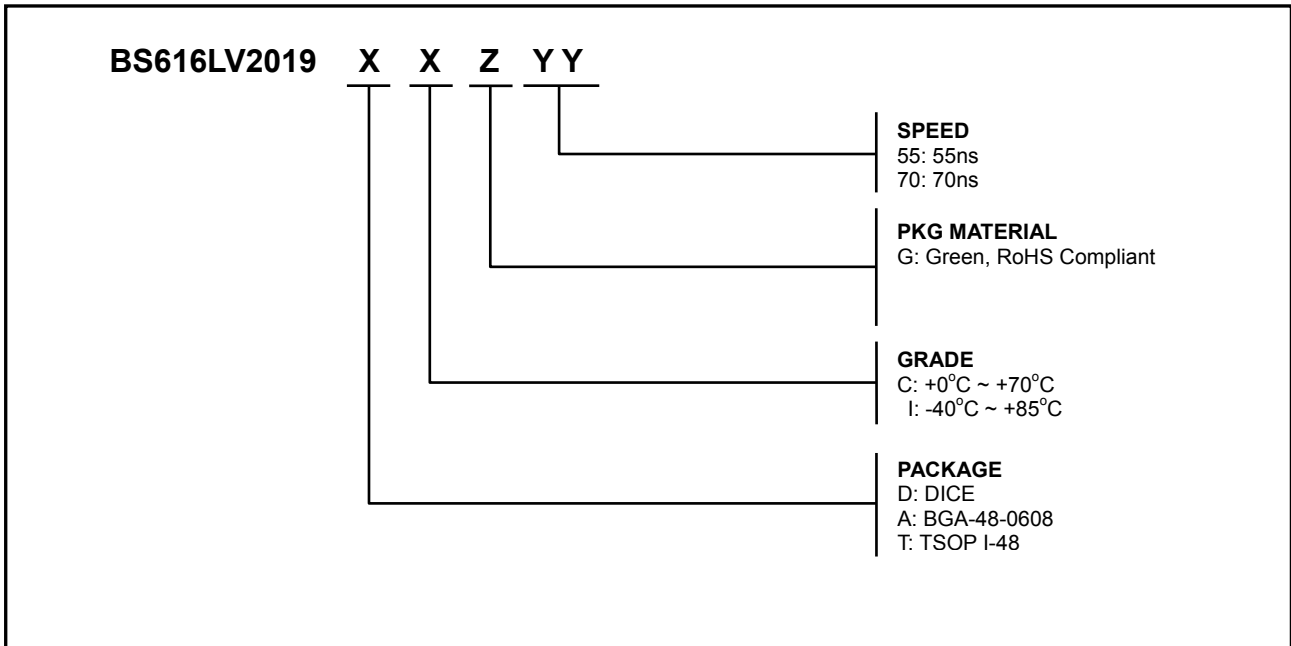

**ORDERING INFORMATION**

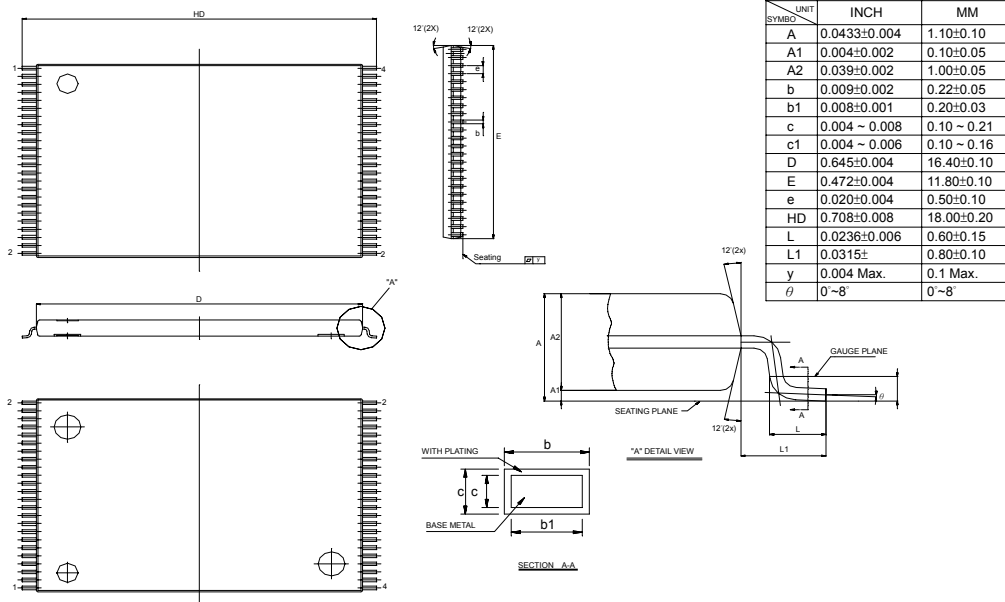
**Note:**

BSI (Brilliance Semiconductor Inc.) assumes no responsibility for the application or use of any product or circuit described herein. BSI does not authorize its products for use as critical components in any application in which the failure of the BSI product may be expected to result in significant injury or death, including life-support systems and critical medical instruments.

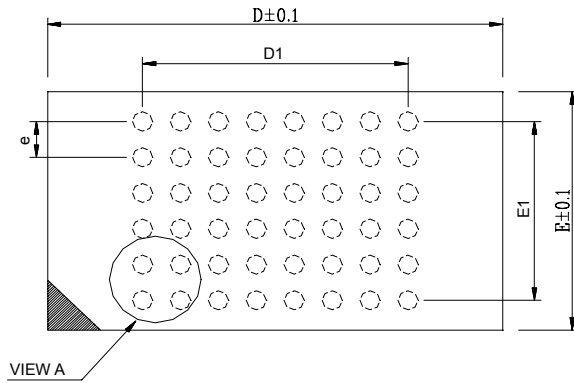
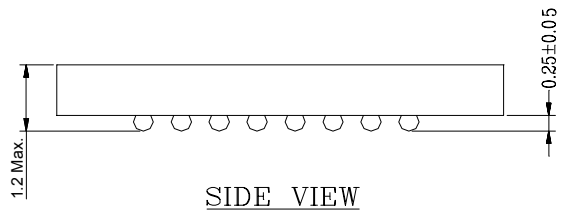
**PACKAGE DIMENSIONS**

**TSOP I-48 Pin**

**■ PACKAGE DIMENSIONS (continued)**

**48 mini-BGA (6 x 8mm)**

**NOTES**

- 1: CONTROLLING DIMENSIONS ARE IN MILLIMETERS.
- 2: PIN#1 DOT MARKING BY LASER OR PAD PRINT.
- 3: SYMBOL "N" IS THE NUMBER OF SOLDER BALLS.

BALL PITCH e = 0.75				
D	E	N	D1	E1
8.0	6.0	48	5.25	3.75

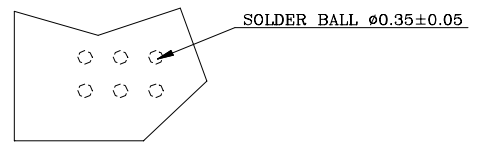

**VIEW A**

**■ Revision History**

<u>Revision No.</u>	<u>History</u>	<u>Draft Date</u>	<u>Remark</u>
1.2	Add Icc1 characteristic parameter	Jan. 13, 2006	
1.3	Change I-grade operation temperature range - from -25°C to -40°C	May. 25, 2006	
1.4	Typical value of standby current is replaced by maximum value in Features and Description section  Remove “-: Normal” (Leaded) PKG Material in ordering information  Remove “P: Pb free, RoHS Compliant” PKG Material In ordering information	Oct. 31, 2008	