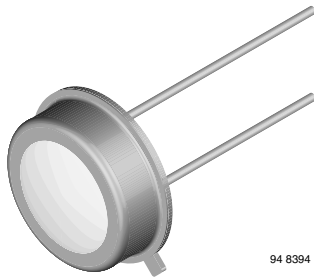


## Silicon Photodiode



94 8394

### DESCRIPTION

BPW21R is a planar Silicon PN photodiode in a hermetically sealed short TO-5 case, especially designed for high precision linear applications.

Due to its extremely high dark resistance, the short circuit photocurrent is linear over seven decades of illumination level.

On the other hand, there is a strictly logarithmic correlation between open circuit voltage and illumination over the same range.

The device is equipped with a flat glass window with built in color correction filter, giving an approximation to the spectral response of the human eye.

### FEATURES

- Package type: leaded
- Package form: TO-5
- Dimensions (in mm):  $\varnothing$  8.13
- Radiant sensitive area (in mm<sup>2</sup>): 7.5
- High photo sensitivity
- Adapted to human eye responsivity
- Angle of half sensitivity:  $\varphi = \pm 50^\circ$
- Hermetically sealed package
- Cathode connected to package
- Flat glass window
- Low dark current
- High shunt resistance
- High linearity
- Compliant to RoHS Directive 2002/95/EC and in accordance with WEEE 2002/96/EC


**RoHS**  
COMPLIANT

### APPLICATIONS

- Sensor in exposure and color measuring purposes

### PRODUCT SUMMARY

COMPONENT	$I_{ra}$ ( $\mu$ A)	$\varphi$ (deg)	$\lambda_{0.5}$ (nm)
BPW21R	9	$\pm 50$	420 to 675

#### Note

- Test condition see table "Basic Characteristics"

### ORDERING INFORMATION

ORDERING CODE	PACKAGING	REMARKS	PACKAGE FORM
BPW21R	Bulk	MOQ: 500 pcs, 500 pcs/bulk	TO-5

#### Note

- MOQ: minimum order quantity

### ABSOLUTE MAXIMUM RATINGS ( $T_{amb} = 25^\circ\text{C}$ , unless otherwise specified)

PARAMETER	TEST CONDITION	SYMBOL	VALUE	UNIT
Reverse voltage		$V_R$	10	V
Power dissipation	$T_{amb} \leq 50^\circ\text{C}$	$P_V$	300	mW
Junction temperature		$T_j$	125	$^\circ\text{C}$
Operating temperature range		$T_{amb}$	- 40 to + 125	$^\circ\text{C}$
Storage temperature range		$T_{stg}$	- 40 to + 125	$^\circ\text{C}$
Soldering temperature	$t \leq 5$ s	$T_{sd}$	260	$^\circ\text{C}$
Thermal resistance junction/ambient	Connected with Cu wire, 0.14 mm <sup>2</sup>	$R_{thJA}$	250	K/W

<b>BASIC CHARACTERISTICS</b> ( $T_{amb} = 25\text{ }^{\circ}\text{C}$ , unless otherwise specified)						
PARAMETER	TEST CONDITION	SYMBOL	MIN.	TYP.	MAX.	UNIT
Forward voltage	$I_F = 50\text{ mA}$	$V_F$		1.0	1.3	V
Breakdown voltage	$I_R = 20\text{ }\mu\text{A}$ , $E = 0$	$V_{(BR)}$	10			V
Reverse dark current	$V_R = 5\text{ V}$ , $E = 0$	$I_{ro}$		2	30	nA
Diode capacitance	$V_R = 0\text{ V}$ , $f = 1\text{ MHz}$ , $E = 0$	$C_D$		1.2		nF
	$V_R = 5\text{ V}$ , $f = 1\text{ MHz}$ , $E = 0$	$C_D$		400		pF
Dark resistance	$V_R = 10\text{ mV}$	$R_D$		38		$\text{G}\Omega$
Open circuit voltage	$E_A = 1\text{ klx}$	$V_o$	280	450		mV
Temperature coefficient of $V_o$	$E_A = 1\text{ klx}$	$\text{TK}_{V_o}$		-2		mV/K
Short circuit current	$E_A = 1\text{ klx}$	$I_k$	4.5	9		$\mu\text{A}$
Temperature coefficient of $I_k$	$E_A = 1\text{ klx}$	$\text{TK}_{I_k}$		-0.05		%/K
Reverse light current	$E_A = 1\text{ klx}$ , $V_R = 5\text{ V}$	$I_{ra}$	4.5	9		$\mu\text{A}$
Sensitivity	$V_R = 5\text{ V}$ , $E_A = 10^{-2}$ to $10^5\text{ lx}$	S		9		nA/lx
Angle of half sensitivity		$\varphi$		$\pm 50$		deg
Wavelength of peak sensitivity		$\lambda_p$		565		nm
Range of spectral bandwidth		$\lambda_{0.5}$		420 to 675		nm
Rise time	$V_R = 0\text{ V}$ , $R_L = 1\text{ k}\Omega$ , $\lambda = 660\text{ nm}$	$t_r$		3.1		$\mu\text{s}$
Fall time	$V_R = 0\text{ V}$ , $R_L = 1\text{ k}\Omega$ , $\lambda = 660\text{ nm}$	$t_f$		3.0		$\mu\text{s}$

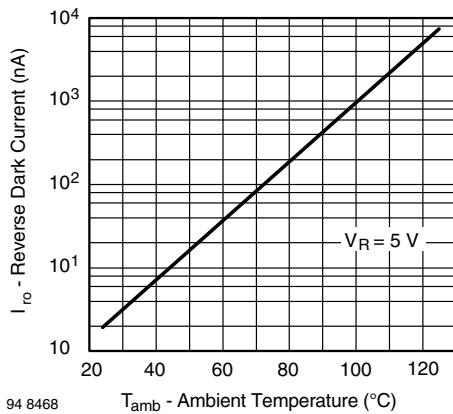
**BASIC CHARACTERISTICS** ( $T_{amb} = 25\text{ }^{\circ}\text{C}$ , unless otherwise specified)


Fig. 1 - Reverse Dark Current vs. Ambient Temperature

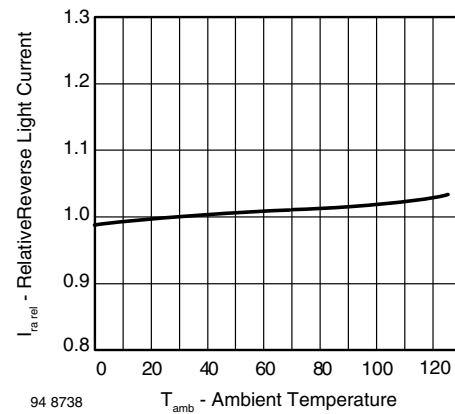


Fig. 2 - Relative Reverse Light Current vs. Ambient Temperature

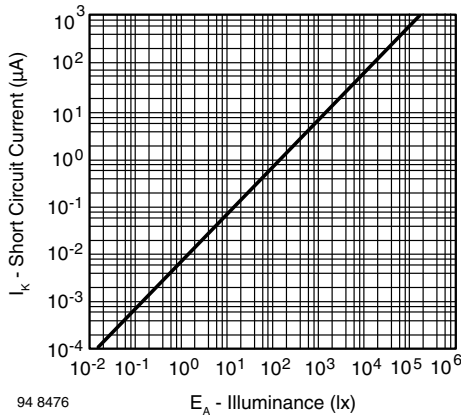


Fig. 3 - Short Circuit Current vs. Illuminance

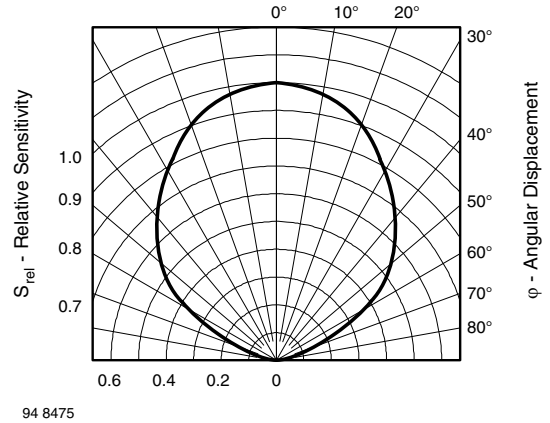


Fig. 6 - Relative Radiant Sensitivity vs. Angular Displacement

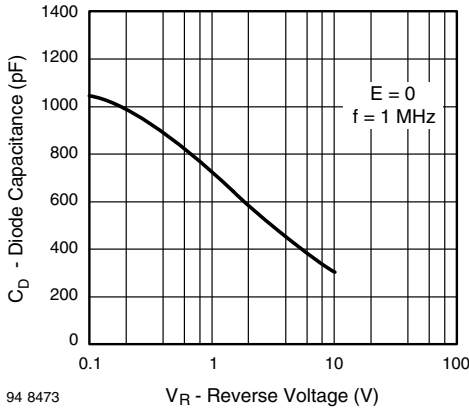


Fig. 4 - Diode Capacitance vs. Reverse Voltage

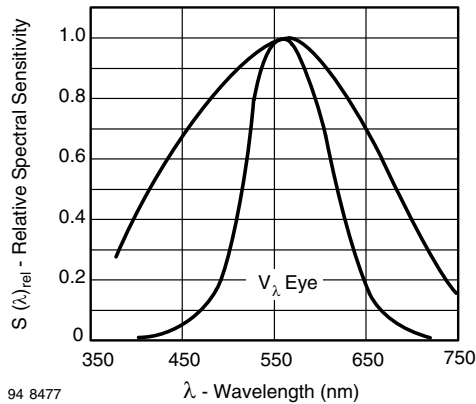
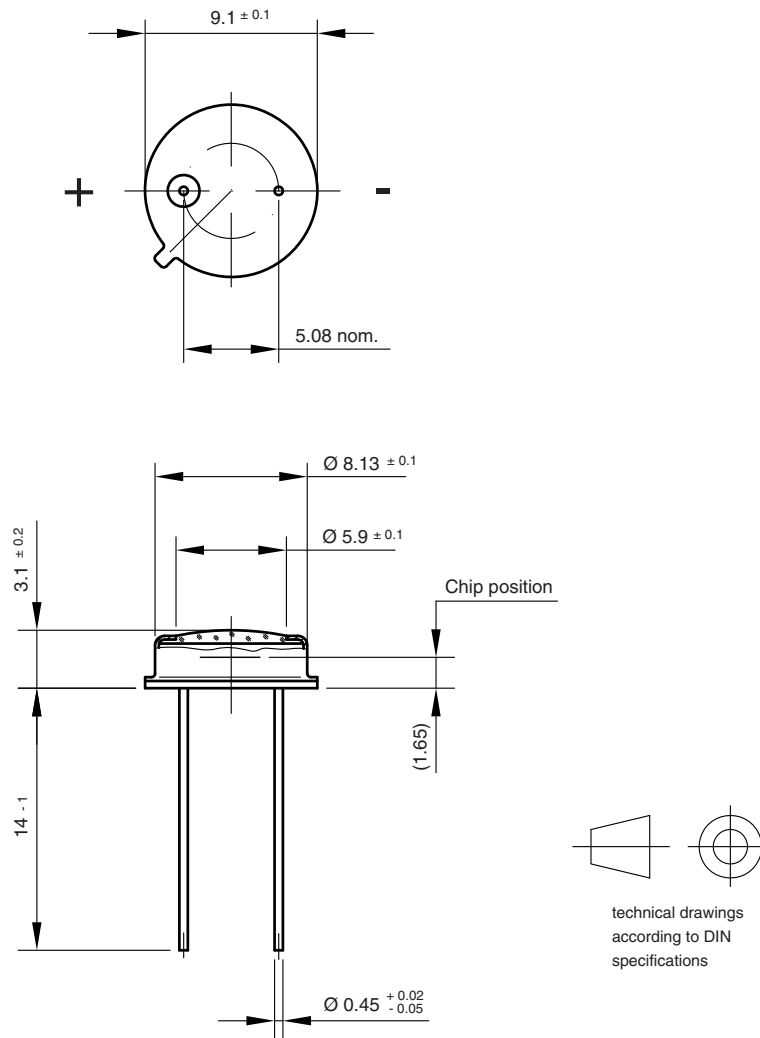


Fig. 5 - Relative Spectral Sensitivity vs. Wavelength



## PACKAGE DIMENSIONS in millimeters



Drawing-No.: 6.511-5002.01-4

Issue:1; 01.07.96

96 12181



## **Disclaimer**

ALL PRODUCT, PRODUCT SPECIFICATIONS AND DATA ARE SUBJECT TO CHANGE WITHOUT NOTICE TO IMPROVE RELIABILITY, FUNCTION OR DESIGN OR OTHERWISE.

Vishay Intertechnology, Inc., its affiliates, agents, and employees, and all persons acting on its or their behalf (collectively, "Vishay"), disclaim any and all liability for any errors, inaccuracies or incompleteness contained in any datasheet or in any other disclosure relating to any product.

Vishay makes no warranty, representation or guarantee regarding the suitability of the products for any particular purpose or the continuing production of any product. To the maximum extent permitted by applicable law, Vishay disclaims (i) any and all liability arising out of the application or use of any product, (ii) any and all liability, including without limitation special, consequential or incidental damages, and (iii) any and all implied warranties, including warranties of fitness for particular purpose, non-infringement and merchantability.

Statements regarding the suitability of products for certain types of applications are based on Vishay's knowledge of typical requirements that are often placed on Vishay products in generic applications. Such statements are not binding statements about the suitability of products for a particular application. It is the customer's responsibility to validate that a particular product with the properties described in the product specification is suitable for use in a particular application. Parameters provided in datasheets and / or specifications may vary in different applications and performance may vary over time. All operating parameters, including typical parameters, must be validated for each customer application by the customer's technical experts. Product specifications do not expand or otherwise modify Vishay's terms and conditions of purchase, including but not limited to the warranty expressed therein.

Except as expressly indicated in writing, Vishay products are not designed for use in medical, life-saving, or life-sustaining applications or for any other application in which the failure of the Vishay product could result in personal injury or death. Customers using or selling Vishay products not expressly indicated for use in such applications do so at their own risk. Please contact authorized Vishay personnel to obtain written terms and conditions regarding products designed for such applications.

No license, express or implied, by estoppel or otherwise, to any intellectual property rights is granted by this document or by any conduct of Vishay. Product names and markings noted herein may be trademarks of their respective owners.