

BFU790F

NPN wideband silicon germanium RF transistor

Rev. 1 — 22 April 2011

Product data sheet

1. Product profile

1.1 General description

NPN silicon germanium microwave transistor for high speed, low noise applications in a plastic, 4-pin dual-emitter SOT343F package.

CAUTION



This device is sensitive to ElectroStatic Discharge (ESD). Observe precautions for handling electrostatic sensitive devices.

Such precautions are described in the *ANSI/ESD S20.20*, *IEC/ST 61340-5*, *JESD625-A* or equivalent standards.

1.2 Features and benefits

- Low noise high linearity microwave transistor
- 110 GHz f_T silicon germanium technology
- High maximum output power at 1 dB compression 20 dBm at 1.8 GHz

1.3 Applications

- High linearity applications
- Medium output power applications
- Wi-Fi / WLAN / WiMAX
- ZigBee
- LTE, cellular, UMTS



1.4 Quick reference data

Table 1. Quick reference data

Symbol	Parameter	Conditions	Min	Typ	Max	Unit
V_{CBO}	collector-base voltage	open emitter	-	-	10	V
V_{CEO}	collector-emitter voltage	open base	-	-	2.8	V
V_{EBO}	emitter-base voltage	open collector	-	-	1.0	V
I_C	collector current		-	50	100	mA
P_{tot}	total power dissipation	$T_{sp} \leq 90\text{ °C}$	[1]	-	234	mW
h_{FE}	DC current gain	$I_C = 10\text{ mA}; V_{CE} = 2\text{ V}; T_j = 25\text{ °C}$	235	410	585	
C_{CBS}	collector-base capacitance	$V_{CB} = 2\text{ V}; f = 1\text{ MHz}$	-	514	-	fF
f_T	transition frequency	$I_C = 100\text{ mA}; V_{CE} = 1\text{ V}; f = 2\text{ GHz}; T_{amb} = 25\text{ °C}$	-	25	-	GHz
$IP3O$	output third-order intercept point	$I_C = 30\text{ mA}; V_{CE} = 2.5\text{ V}; f = 1.8\text{ GHz}; T_{amb} = 25\text{ °C}$	-	33	-	dBm
$G_{p(max)}$	maximum power gain	$I_C = 85\text{ mA}; V_{CE} = 1\text{ V}; f = 1.8\text{ GHz}; T_{amb} = 25\text{ °C}$	[2]	-	19.5	dB
NF	noise figure	$I_C = 20\text{ mA}; V_{CE} = 2\text{ V}; \Gamma_S = \Gamma_{opt}; f = 1.8\text{ GHz}; T_{amb} = 25\text{ °C}$	-	0.40	-	dB
$P_{L(1dB)}$	output power at 1 dB gain compression	$I_C = 60\text{ mA}; V_{CE} = 2.5\text{ V}; Z_S = Z_L = 50\text{ }\Omega; f = 1.8\text{ GHz}; T_{amb} = 25\text{ °C}$	-	20	-	dBm

[1] T_{sp} is the temperature at the solder point of the emitter lead.

[2] $G_{p(max)}$ is the maximum power gain, if $K > 1$. If $K < 1$ then $G_{p(max)}$ = Maximum Stable Gain (MSG).

2. Pinning information

Table 2. Discrete pinning

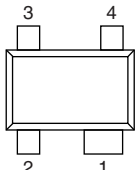
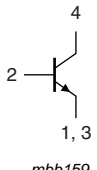
Pin	Description	Simplified outline	Graphic symbol
1	emitter		
2	base		
3	emitter		
4	collector		

3. Ordering information

Table 3. Ordering information

Type number	Package		Version
	Name	Description	
BFU790F	-	plastic surface-mounted flat pack package; reverse pinning; 4 leads	SOT343F

4. Marking

Table 4. Marking

Type number	Marking	Description
BFU790F	D8*	* = p : made in Hong Kong * = t : made in Malaysia * = w : made in China

5. Limiting values

Table 5. Limiting values

In accordance with the Absolute Maximum Rating System (IEC 60134).

Symbol	Parameter	Conditions	Min	Max	Unit
V_{CBO}	collector-base voltage	open emitter	-	10	V
V_{CEO}	collector-emitter voltage	open base	-	2.8	V
V_{EBO}	emitter-base voltage	open collector	-	1.0	V
I_C	collector current		-	100	mA
P_{tot}	total power dissipation	$T_{sp} \leq 90\text{ °C}$	[1]	234	mW
T_{stg}	storage temperature		-65	+150	°C
T_j	junction temperature		-	150	°C

[1] T_{sp} is the temperature at the solder point of the emitter lead.

6. Thermal characteristics

Table 6. Thermal characteristics

Symbol	Parameter	Conditions	Typ	Unit
$R_{th(j-sp)}$	thermal resistance from junction to solder point		256	K/W

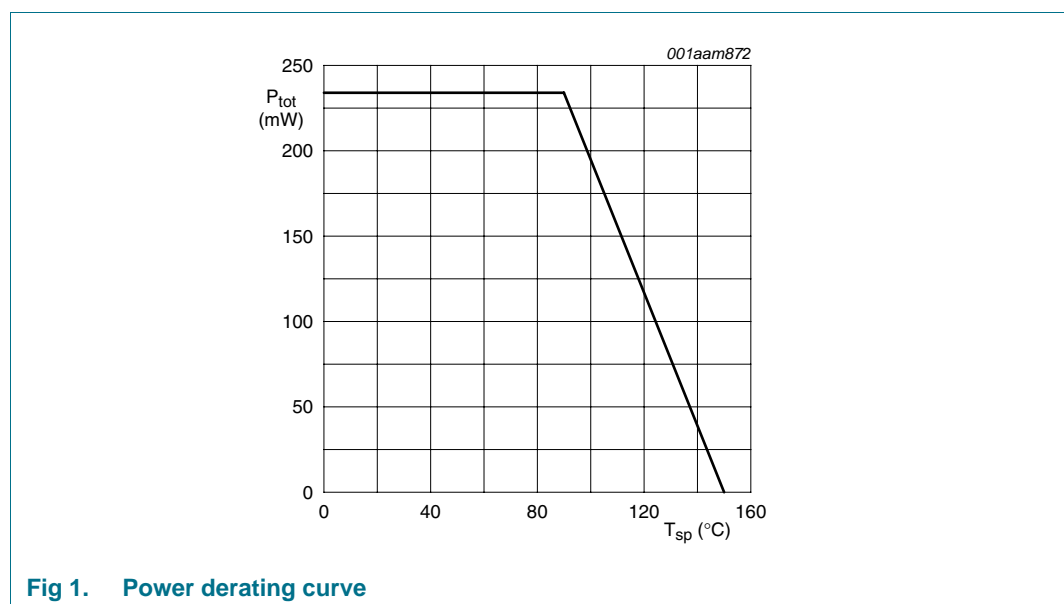

Fig 1. Power derating curve

7. Characteristics

Table 7. Characteristics

$T_j = 25\text{ °C}$ unless otherwise specified

Symbol	Parameter	Conditions	Min	Typ	Max	Unit
$V_{(BR)CBO}$	collector-base breakdown voltage	$I_C = 2.5\ \mu\text{A}; I_E = 0\ \text{mA}$	10	-	-	V
$V_{(BR)CEO}$	collector-emitter breakdown voltage	$I_C = 1\ \text{mA}; I_B = 0\ \text{mA}$	2.8	-	-	V
I_C	collector current		-	50	100	mA
I_{CBO}	collector-base cut-off current	$I_E = 0\ \text{mA}; V_{CB} = 4.5\ \text{V}$	-	-	100	nA
h_{FE}	DC current gain	$I_C = 10\ \text{mA}; V_{CE} = 2\ \text{V}$	235	410	585	
C_{CES}	collector-emitter capacitance	$V_{CB} = 2\ \text{V}; f = 1\ \text{MHz}$	-	527	-	fF
C_{EBS}	emitter-base capacitance	$V_{EB} = 0.5\ \text{V}; f = 1\ \text{MHz}$	-	2817	-	fF
C_{CBS}	collector-base capacitance	$V_{CB} = 2\ \text{V}; f = 1\ \text{MHz}$	-	514	-	fF
f_T	transition frequency	$I_C = 100\ \text{mA}; V_{CE} = 1\ \text{V}; f = 2\ \text{GHz}; T_{amb} = 25\text{ °C}$	-	25	-	GHz
$G_{p(max)}$	maximum power gain	$I_C = 85\ \text{mA}; V_{CE} = 1\ \text{V}; T_{amb} = 25\text{ °C}$	[1]			
		$f = 1.5\ \text{GHz}$	-	21	-	dB
		$f = 1.8\ \text{GHz}$	-	19.5	-	dB
		$f = 2.4\ \text{GHz}$	-	16.5	-	dB
$ s_{21} ^2$	insertion power gain	$I_C = 85\ \text{mA}; V_{CE} = 1\ \text{V}; T_{amb} = 25\text{ °C}$				
		$f = 1.5\ \text{GHz}$	-	14.5	-	dB
		$f = 1.8\ \text{GHz}$	-	13	-	dB
		$f = 2.4\ \text{GHz}$	-	10.5	-	dB
NF	noise figure	$I_C = 20\ \text{mA}; V_{CE} = 2\ \text{V}; \Gamma_S = \Gamma_{opt}; T_{amb} = 25\text{ °C}$				
		$f = 1.5\ \text{GHz}$	-	0.40	-	dB
		$f = 1.8\ \text{GHz}$	-	0.40	-	dB
		$f = 2.4\ \text{GHz}$	-	0.50	-	dB
G_{ass}	associated gain	$I_C = 20\ \text{mA}; V_{CE} = 2\ \text{V}; \Gamma_S = \Gamma_{opt}; T_{amb} = 25\text{ °C}$				
		$f = 1.5\ \text{GHz}$	-	19	-	dB
		$f = 1.8\ \text{GHz}$	-	17.5	-	dB
		$f = 2.4\ \text{GHz}$	-	15.7	-	dB
$P_{L(1dB)}$	output power at 1 dB gain compression	$I_C = 60\ \text{mA}; V_{CE} = 2.5\ \text{V}; Z_S = Z_L = 50\ \Omega; T_{amb} = 25\text{ °C}$				
		$f = 1.5\ \text{GHz}$	-	20	-	dBm
		$f = 1.8\ \text{GHz}$	-	20	-	dBm
		$f = 2.4\ \text{GHz}$	-	19	-	dBm
IP3	third-order intercept point	$I_C = 30\ \text{mA}; V_{CE} = 2.5\ \text{V}; Z_S = Z_L = 50\ \Omega; T_{amb} = 25\text{ °C}$				
		$f = 1.5\ \text{GHz}$	-	33	-	dBm
		$f = 1.8\ \text{GHz}$	-	33	-	dBm
		$f = 2.4\ \text{GHz}$	-	34	-	dBm
		$f = 5.8\ \text{GHz}$	-	33	-	dBm

[1] $G_{p(max)}$ is the maximum power gain, if $K > 1$. If $K < 1$ then $G_{p(max)} = \text{MSG}$.

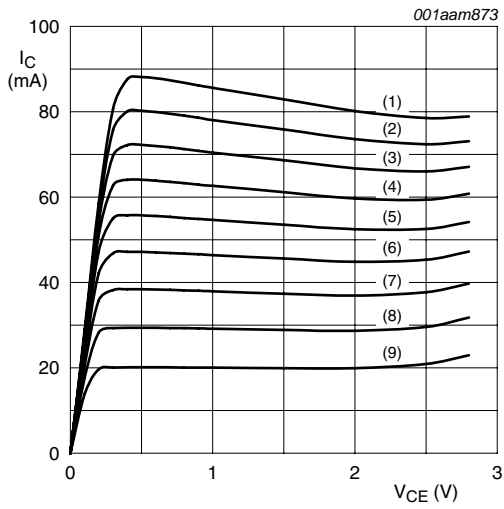

- $T_{amb} = 25\text{ }^{\circ}\text{C}.$
- (1) $I_B = 250\text{ }\mu\text{A}$
 - (2) $I_B = 225\text{ }\mu\text{A}$
 - (3) $I_B = 200\text{ }\mu\text{A}$
 - (4) $I_B = 175\text{ }\mu\text{A}$
 - (5) $I_B = 150\text{ }\mu\text{A}$
 - (6) $I_B = 125\text{ }\mu\text{A}$
 - (7) $I_B = 100\text{ }\mu\text{A}$
 - (8) $I_B = 75\text{ }\mu\text{A}$
 - (9) $I_B = 50\text{ }\mu\text{A}$

Fig 2. Collector current as a function of collector-emitter voltage; typical values

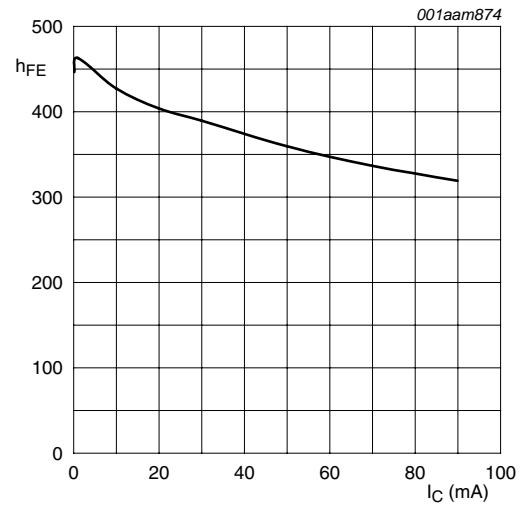

$V_{CE} = 2\text{ V}; T_{amb} = 25\text{ }^{\circ}\text{C}.$

Fig 3. DC current gain as a function of collector current; typical values

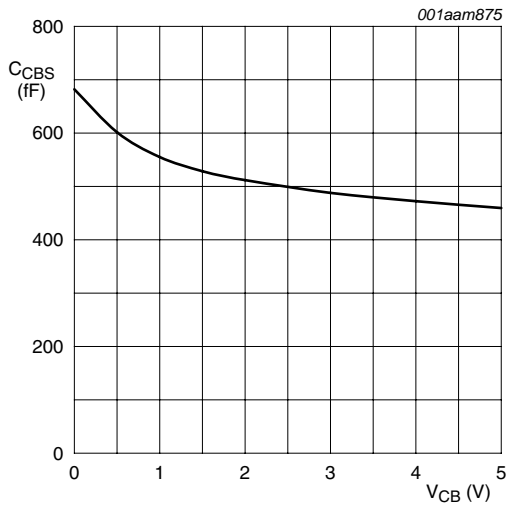

$f = 1 \text{ MHz}$, $T_{amb} = 25 \text{ }^\circ\text{C}$.

Fig 4. Collector-base capacitance as a function of collector-base voltage; typical values

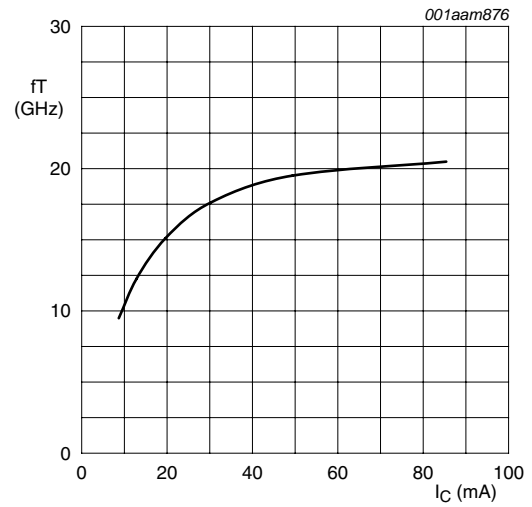

$V_{CE} = 1 \text{ V}$; $f = 2 \text{ GHz}$; $T_{amb} = 25 \text{ }^\circ\text{C}$.

Fig 5. Transition frequency as a function of collector current; typical values

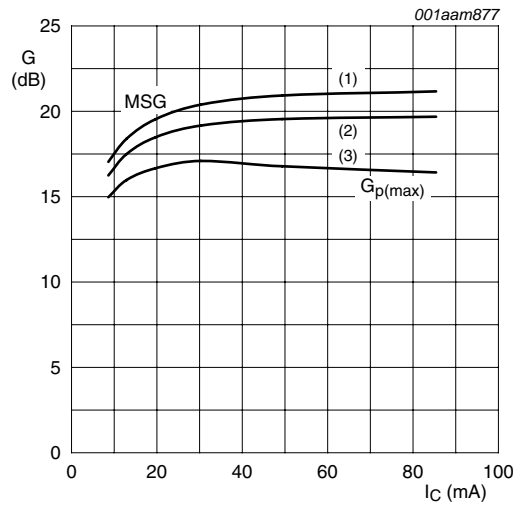

$V_{CE} = 1 \text{ V}$; $T_{amb} = 25 \text{ }^\circ\text{C}$.

- (1) $f = 1.5 \text{ GHz}$
- (2) $f = 1.8 \text{ GHz}$
- (3) $f = 2.4 \text{ GHz}$

Fig 6. Gain as a function of collector current; typical value

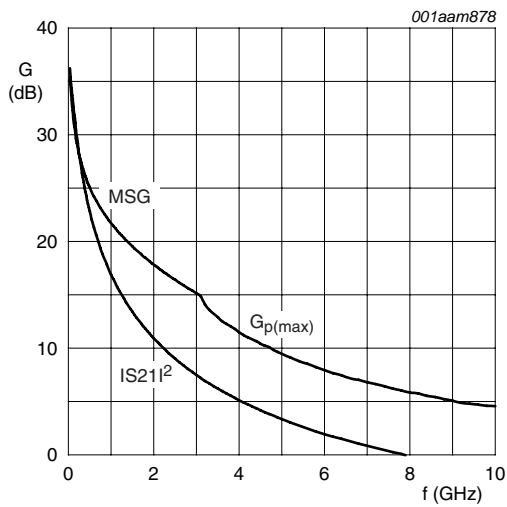

$V_{CE} = 1\text{ V}; I_C = 20\text{ mA}; T_{amb} = 25\text{ }^\circ\text{C}.$

Fig 7. Gain as a function of frequency; typical values

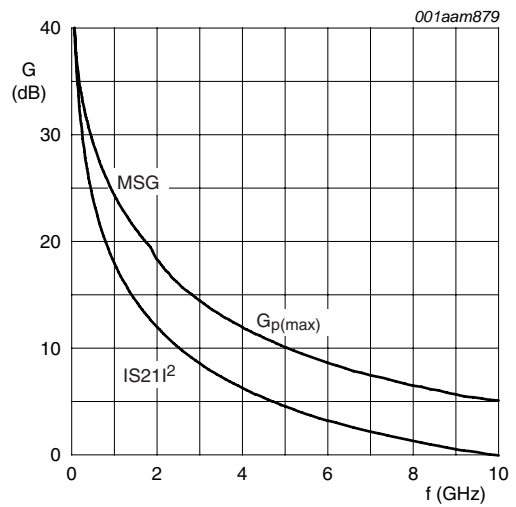

$V_{CE} = 1\text{ V}; I_C = 85\text{ mA}; T_{amb} = 25\text{ }^\circ\text{C}.$

Fig 8. Gain as a function of frequency; typical values

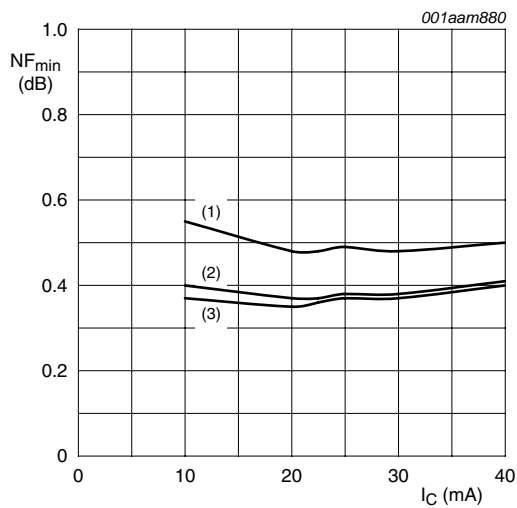

$V_{CE} = 2\text{ V}; T_{amb} = 25\text{ }^\circ\text{C}.$

- (1) $f = 2.4\text{ GHz}$
- (2) $f = 1.8\text{ GHz}$
- (3) $f = 1.5\text{ GHz}$

Fig 9. Minimum noise figure as a function of collector current; typical values

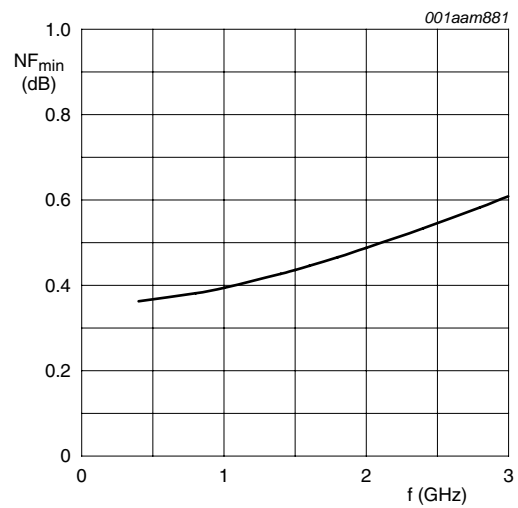

$I_C = 20\text{ mA}; V_{CE} = 2\text{ V}; T_{amb} = 25\text{ }^\circ\text{C}.$

Fig 10. Minimum noise figure as a function of frequency; typical values

8. Package outline

Plastic surface-mounted flat pack package; reverse pinning; 4 leads

SOT343F

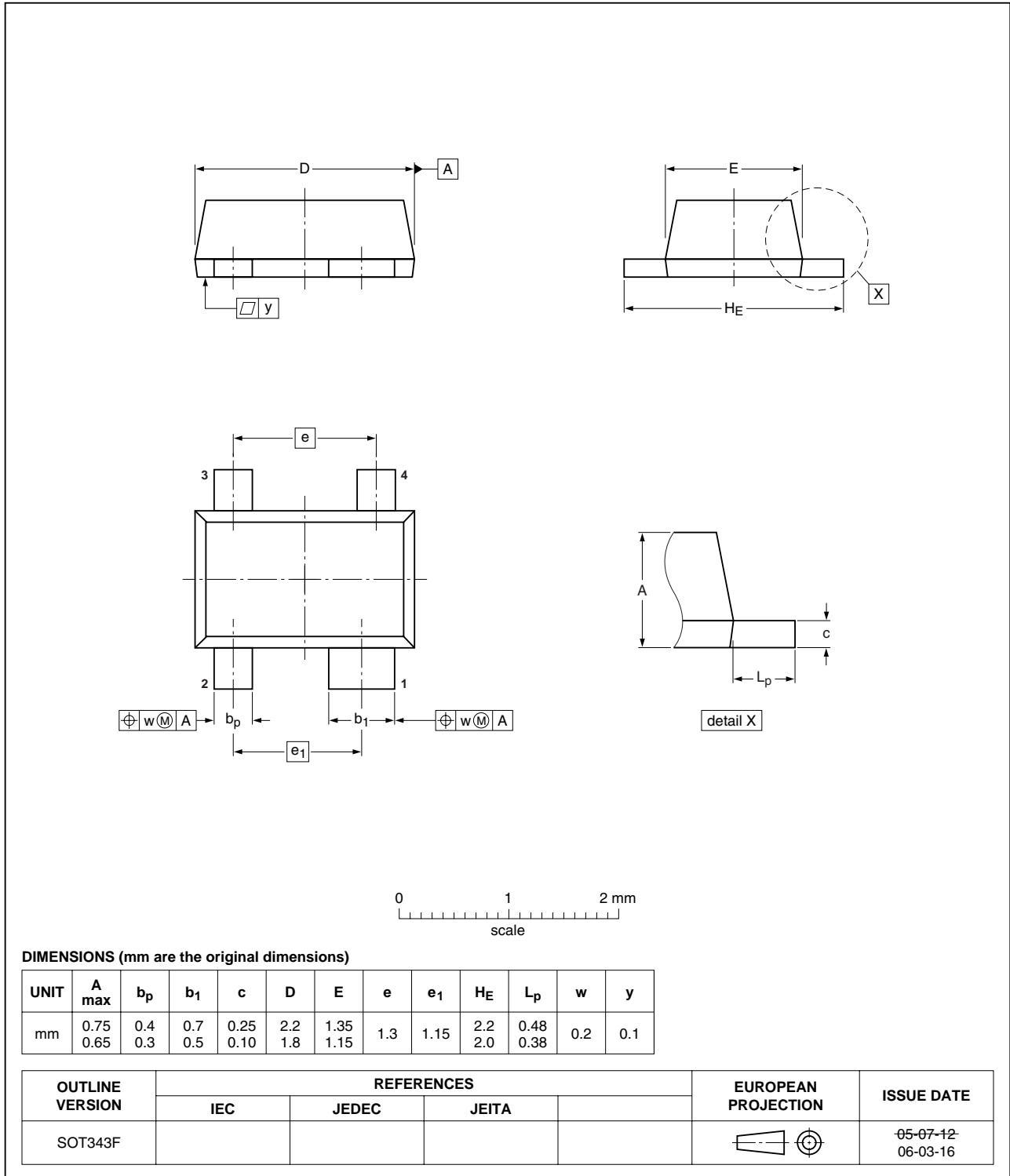

Fig 11. Package outline SOT343F

9. Abbreviations

Table 8. Abbreviations

Acronym	Description
DC	Direct Current
LTE	Long Term Evolution
NPN	Negative-Positive-Negative
RF	Radio Frequency
UMTS	Universal Mobile Telecommunications System
WiMAX	Worldwide Interoperability for Microwave Access
WLAN	Wireless Local Area Network

10. Revision history

Table 9. Revision history

Document ID	Release date	Data sheet status	Change notice	Supersedes
BFU790F v.1	20110422	Product data sheet	-	-

11. Legal information

11.1 Data sheet status

Document status ^{[1][2]}	Product status ^[3]	Definition
Objective [short] data sheet	Development	This document contains data from the objective specification for product development.
Preliminary [short] data sheet	Qualification	This document contains data from the preliminary specification.
Product [short] data sheet	Production	This document contains the product specification.

[1] Please consult the most recently issued document before initiating or completing a design.

[2] The term 'short data sheet' is explained in section "Definitions".

[3] The product status of device(s) described in this document may have changed since this document was published and may differ in case of multiple devices. The latest product status information is available on the Internet at URL <http://www.nxp.com>.

11.2 Definitions

Draft — The document is a draft version only. The content is still under internal review and subject to formal approval, which may result in modifications or additions. NXP Semiconductors does not give any representations or warranties as to the accuracy or completeness of information included herein and shall have no liability for the consequences of use of such information.

Short data sheet — A short data sheet is an extract from a full data sheet with the same product type number(s) and title. A short data sheet is intended for quick reference only and should not be relied upon to contain detailed and full information. For detailed and full information see the relevant full data sheet, which is available on request via the local NXP Semiconductors sales office. In case of any inconsistency or conflict with the short data sheet, the full data sheet shall prevail.

Product specification — The information and data provided in a Product data sheet shall define the specification of the product as agreed between NXP Semiconductors and its customer, unless NXP Semiconductors and customer have explicitly agreed otherwise in writing. In no event however, shall an agreement be valid in which the NXP Semiconductors product is deemed to offer functions and qualities beyond those described in the Product data sheet.

11.3 Disclaimers

Limited warranty and liability — Information in this document is believed to be accurate and reliable. However, NXP Semiconductors does not give any representations or warranties, expressed or implied, as to the accuracy or completeness of such information and shall have no liability for the consequences of use of such information.

In no event shall NXP Semiconductors be liable for any indirect, incidental, punitive, special or consequential damages (including - without limitation - lost profits, lost savings, business interruption, costs related to the removal or replacement of any products or rework charges) whether or not such damages are based on tort (including negligence), warranty, breach of contract or any other legal theory.

Notwithstanding any damages that customer might incur for any reason whatsoever, NXP Semiconductors' aggregate and cumulative liability towards customer for the products described herein shall be limited in accordance with the *Terms and conditions of commercial sale* of NXP Semiconductors.

Right to make changes — NXP Semiconductors reserves the right to make changes to information published in this document, including without limitation specifications and product descriptions, at any time and without notice. This document supersedes and replaces all information supplied prior to the publication hereof.

Suitability for use — NXP Semiconductors products are not designed, authorized or warranted to be suitable for use in life support, life-critical or safety-critical systems or equipment, nor in applications where failure or

malfunction of an NXP Semiconductors product can reasonably be expected to result in personal injury, death or severe property or environmental damage. NXP Semiconductors accepts no liability for inclusion and/or use of NXP Semiconductors products in such equipment or applications and therefore such inclusion and/or use is at the customer's own risk.

Applications — Applications that are described herein for any of these products are for illustrative purposes only. NXP Semiconductors makes no representation or warranty that such applications will be suitable for the specified use without further testing or modification.

Customers are responsible for the design and operation of their applications and products using NXP Semiconductors products, and NXP Semiconductors accepts no liability for any assistance with applications or customer product design. It is customer's sole responsibility to determine whether the NXP Semiconductors product is suitable and fit for the customer's applications and products planned, as well as for the planned application and use of customer's third party customer(s). Customers should provide appropriate design and operating safeguards to minimize the risks associated with their applications and products.

NXP Semiconductors does not accept any liability related to any default, damage, costs or problem which is based on any weakness or default in the customer's applications or products, or the application or use by customer's third party customer(s). Customer is responsible for doing all necessary testing for the customer's applications and products using NXP Semiconductors products in order to avoid a default of the applications and the products or of the application or use by customer's third party customer(s). NXP does not accept any liability in this respect.

Limiting values — Stress above one or more limiting values (as defined in the Absolute Maximum Ratings System of IEC 60134) will cause permanent damage to the device. Limiting values are stress ratings only and (proper) operation of the device at these or any other conditions above those given in the Recommended operating conditions section (if present) or the Characteristics sections of this document is not warranted. Constant or repeated exposure to limiting values will permanently and irreversibly affect the quality and reliability of the device.

Terms and conditions of commercial sale — NXP Semiconductors products are sold subject to the general terms and conditions of commercial sale, as published at <http://www.nxp.com/profile/terms>, unless otherwise agreed in a valid written individual agreement. In case an individual agreement is concluded only the terms and conditions of the respective agreement shall apply. NXP Semiconductors hereby expressly objects to applying the customer's general terms and conditions with regard to the purchase of NXP Semiconductors products by customer.

No offer to sell or license — Nothing in this document may be interpreted or construed as an offer to sell products that is open for acceptance or the grant, conveyance or implication of any license under any copyrights, patents or other industrial or intellectual property rights.

Export control — This document as well as the item(s) described herein may be subject to export control regulations. Export might require a prior authorization from national authorities.

Non-automotive qualified products — Unless this data sheet expressly states that this specific NXP Semiconductors product is automotive qualified, the product is not suitable for automotive use. It is neither qualified nor tested in accordance with automotive testing or application requirements. NXP Semiconductors accepts no liability for inclusion and/or use of non-automotive qualified products in automotive equipment or applications.

In the event that customer uses the product for design-in and use in automotive applications to automotive specifications and standards, customer (a) shall use the product without NXP Semiconductors' warranty of the product for such automotive applications, use and specifications, and (b) whenever customer uses the product for automotive applications beyond NXP Semiconductors' specifications such use shall be solely at customer's own risk, and (c) customer fully indemnifies NXP Semiconductors for any

liability, damages or failed product claims resulting from customer design and use of the product for automotive applications beyond NXP Semiconductors' standard warranty and NXP Semiconductors' product specifications.

Quick reference data — The Quick reference data is an extract of the product data given in the Limiting values and Characteristics sections of this document, and as such is not complete, exhaustive or legally binding.

11.4 Trademarks

Notice: All referenced brands, product names, service names and trademarks are the property of their respective owners.

12. Contact information

For more information, please visit: <http://www.nxp.com>

For sales office addresses, please send an email to: salesaddresses@nxp.com

13. Contents

1	Product profile	1
1.1	General description	1
1.2	Features and benefits	1
1.3	Applications	1
1.4	Quick reference data	2
2	Pinning information	2
3	Ordering information	2
4	Marking	3
5	Limiting values	3
6	Thermal characteristics	3
7	Characteristics	4
8	Package outline	8
9	Abbreviations	9
10	Revision history	9
11	Legal information	10
11.1	Data sheet status	10
11.2	Definitions	10
11.3	Disclaimers	10
11.4	Trademarks	11
12	Contact information	11
13	Contents	12

Please be aware that important notices concerning this document and the product(s) described herein, have been included in section 'Legal information'.

© NXP B.V. 2011.

All rights reserved.

For more information, please visit: <http://www.nxp.com>

For sales office addresses, please send an email to: salesaddresses@nxp.com

Date of release: 22 April 2011

Document identifier: BFU790F