

## NPN Silicon AF Power Transistors

- For AF drivers and output stages
- High collector current
- High current gain
- Low collector-emitter saturation voltage
- Complementary type: BDP952...BDP956 (PNP)

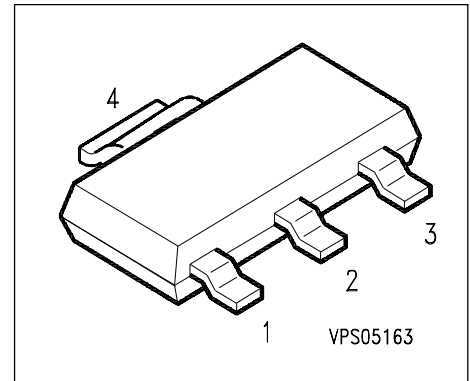

Type	Marking	Ordering Code	Pin Configuration				Package
			1 = B	2 = C	3 = E	4 = C	
BDP 951	BDP 951	Q62702-D1339	1 = B	2 = C	3 = E	4 = C	SOT-223
BDP 953	BDP 953	Q62702-D1341	1 = B	2 = C	3 = E	4 = C	SOT-223
BDP 955	PDP 955	Q62702-D1343	1 = B	2 = C	3 = E	4 = C	SOT-223

### Maximum Ratings

Parameter	Symbol	Values	Unit
Collector-emitter voltage	$V_{CEO}$		V
BDP 951		80	
BDP 953		100	
BDP 955		120	
Collector-base voltage	$V_{CBO}$		
BDP 951		100	
BDP 953		120	
BDP 955		140	
Emitter-base voltage	$V_{EBO}$	5	
DC collector current	$I_C$	3	A
Peak collector current	$I_{CM}$	5	
Base current	$I_B$	200	mA
Peak base current	$I_{BM}$	500	
Total power dissipation, $T_S = 99^\circ\text{C}$	$P_{tot}$	3	W
Junction temperature	$T_j$	150	$^\circ\text{C}$
Storage temperature	$T_{stg}$	- 65 ... + 150	

### Thermal Resistance

Junction ambient <sup>1)</sup>	$R_{thJA}$	$\leq 42$	K/W
Junction - soldering point	$R_{thJS}$	$\leq 17$	

1) Package mounted on pcb 40mm x 40mm x 1.5mm / 6cm<sup>2</sup> Cu

### Electrical Characteristics at $T_A=25^\circ\text{C}$ , unless otherwise specified

Parameter	Symbol	Values			Unit
		min.	typ.	max.	
<b>DC Characteristics</b>					
Collector-emitter breakdown voltage $I_C = 10 \text{ mA}$ , $I_B = 0 \text{ mA}$ , BDP 951 $I_C = 10 \text{ mA}$ , $I_B = 0 \text{ mA}$ , BDP 953 $I_C = 10 \text{ mA}$ , $I_B = 0 \text{ mA}$ , BDP 955	$V_{(BR)CEO}$	80 100 120	- - -	- - -	V
Collector-base breakdown voltage $I_C = 100 \mu\text{A}$ , $I_B = 0$ , BDP 951 $I_C = 100 \mu\text{A}$ , $I_B = 0$ , BDP 953 $I_C = 100 \mu\text{A}$ , $I_B = 0$ , BDP 955	$V_{(BR)CBO}$	100 120 140	- - -	- - -	
Base-emitter breakdown voltage $I_E = 10 \mu\text{A}$ , $I_C = 0$	$V_{(BR)EBO}$	5	-	-	
Collector cutoff current $V_{CB} = 100 \text{ V}$ , $I_E = 0$ , $T_A = 25^\circ\text{C}$ $V_{CB} = 100 \text{ V}$ , $I_E = 0$ , $T_A = 150^\circ\text{C}$	$I_{CBO}$	- -	- -	100 20	nA $\mu\text{A}$
Emitter cutoff current $V_{EB} = 4 \text{ V}$ , $I_C = 0$	$I_{EBO}$	-	-	100	nA
DC current gain $I_C = 10 \text{ mA}$ , $V_{CE} = 5 \text{ V}$ $I_C = 500 \text{ mA}$ , $V_{CE} = 1 \text{ V}$ $I_C = 2 \text{ A}$ , $V_{CE} = 2 \text{ V}$	$h_{FE}$	25 40 15	- - -	- 475 -	-
Collector-emitter saturation voltage 1) $I_C = 2 \text{ A}$ , $I_B = 0.2 \text{ A}$	$V_{CEsat}$	-	-	0.8	V
Base-emitter saturation voltage 1) $I_C = 2 \text{ A}$ , $I_B = 0.2 \text{ A}$	$V_{BEsat}$	-	-	1.5	
<b>AC Characteristics</b>					
Transition frequency $I_C = 50 \text{ mA}$ , $V_{CE} = 10 \text{ V}$ , $f = 100 \text{ MHz}$	$f_T$	-	100	-	MHz
Collector-base capacitance $V_{CB} = 10 \text{ V}$ , $f = 1 \text{ MHz}$	$C_{cb}$	-	25	-	pF

1) Pulse test:  $t < 300\mu\text{s}$ ;  $D < 2\%$

**Total power dissipation  $P_{tot} = f(T_A^*; T_S)$**

\* Package mounted on epoxy

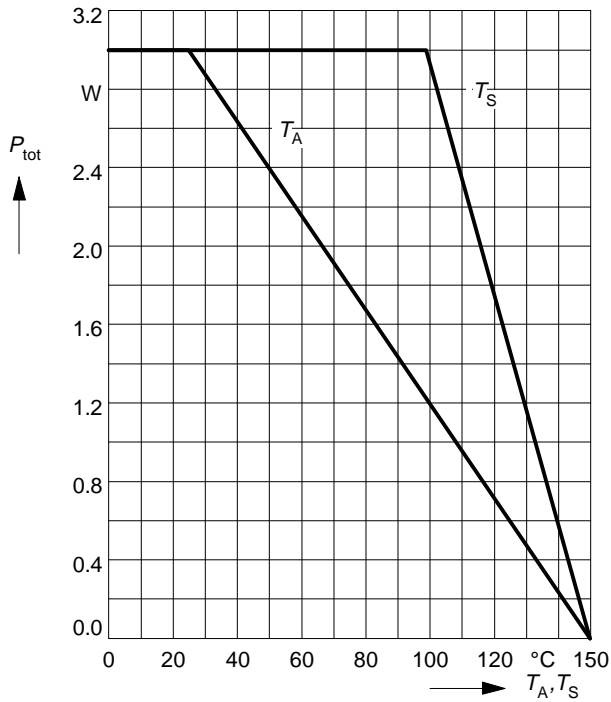

**Permissible Pulse Load  $R_{thJS} = f(t_p)$**

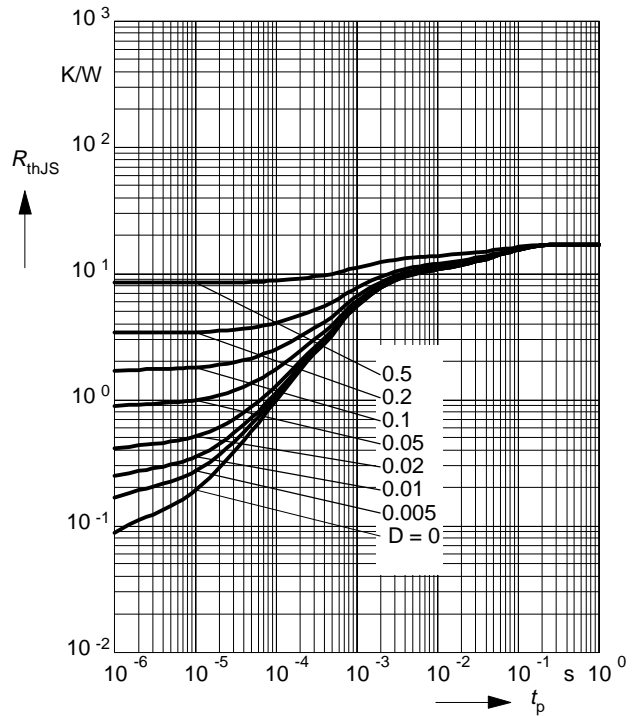

**Permissible Pulse Load  $P_{totmax} / P_{totDC} = f(t_p)$  DC current gain  $h_{FE} = f(I_C)$**

$V_{CE} = 2V$

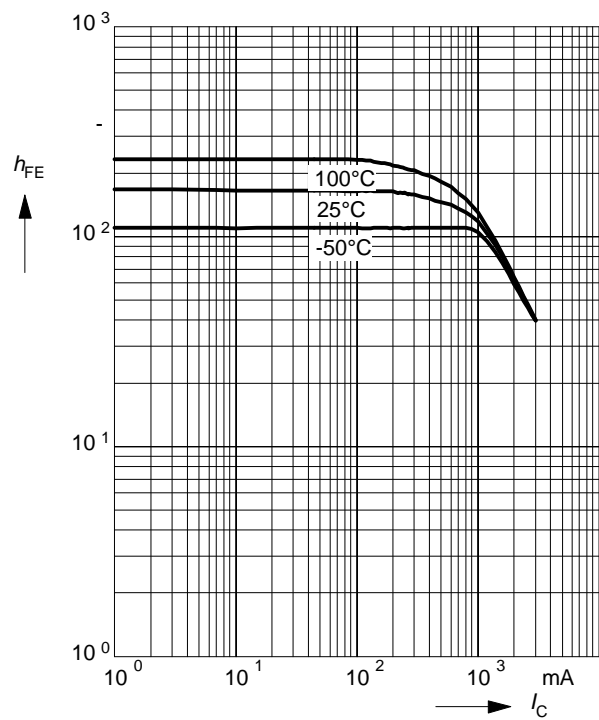
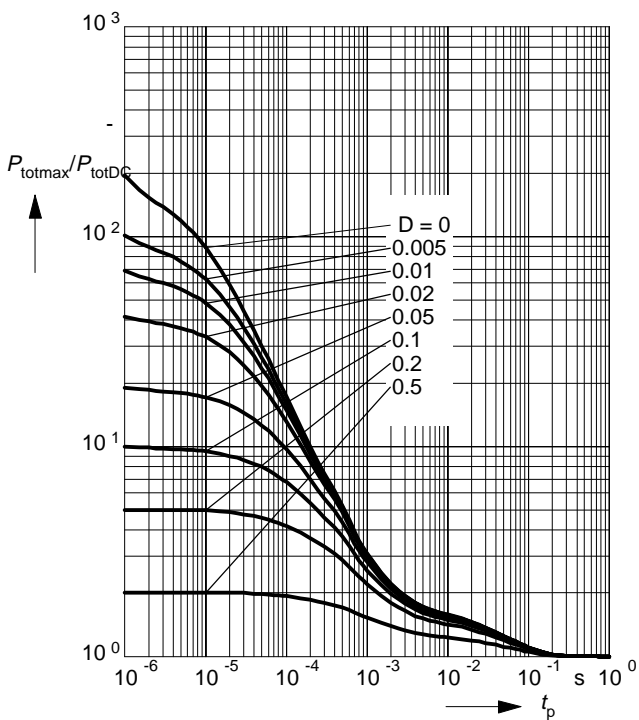

### Collector cutoff current $I_{CBO} = f(T_A)$

$V_{CB} = 45V$

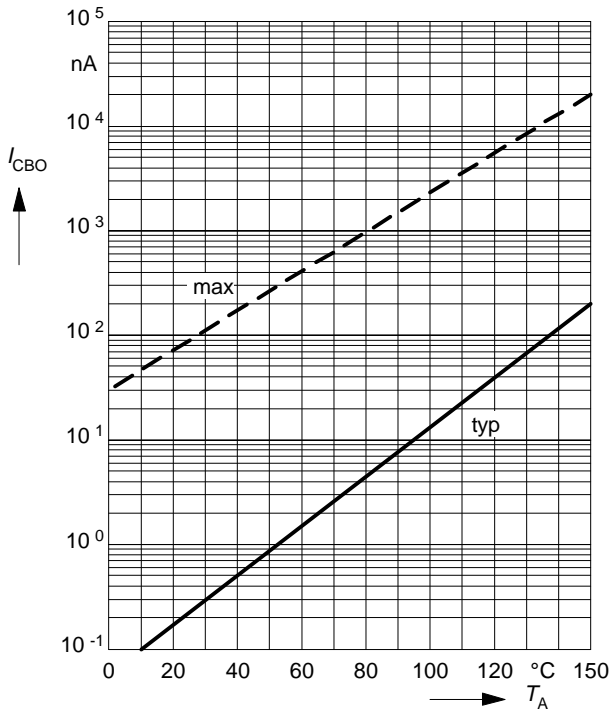

### Collector-emitter saturation voltage $I_C = f(V_{CEsat}), h_{FE} = 10$

$I_C = f(V_{CEsat}), h_{FE} = 10$

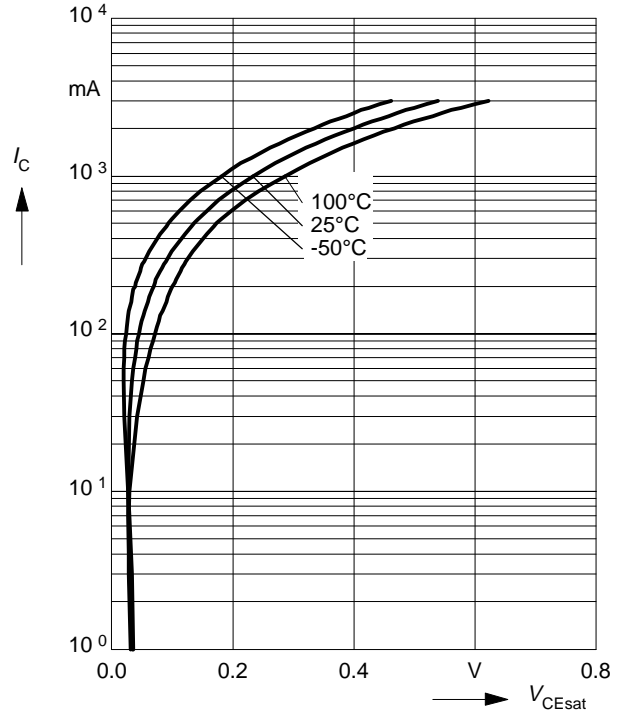

### Base-emitter saturation voltage $I_C = f(V_{BEsat}), h_{FE} = 10$

$I_C = f(V_{BEsat}), h_{FE} = 10$

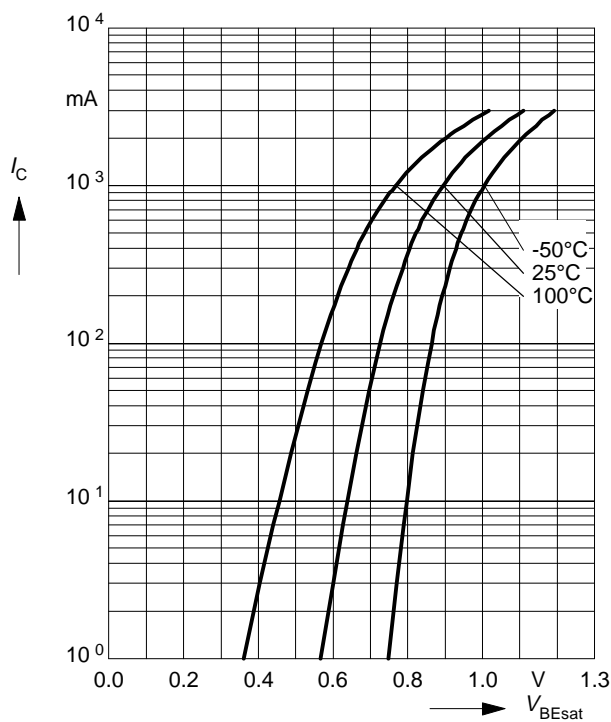

### Collector current $I_C = f(V_{BE})$

$V_{CE} = 2V$

